

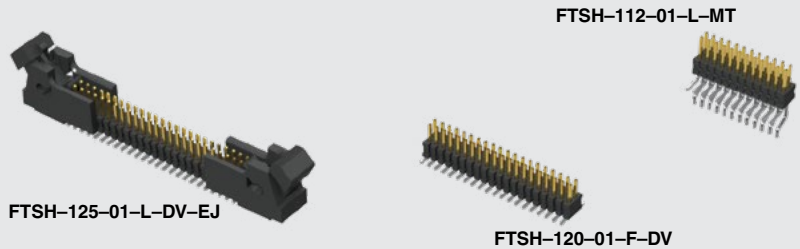

(1.27 mm) .050"



SMT MICRO HEADER

SPECIFICATIONS

For complete specifications and recommended PCB layouts see www.samtec.com?FTSH

Insulator Material: Black Liquid Crystal Polymer

Terminal Material: Phosphor Bronze

Plating: Sn or Au over 50 μ" (1.27 μm) Ni

Current Rating (FTSH/CLP): 3.4 A per pin (2 pins powered)

Operating Temp Range: -55 °C to +125 °C

RoHS Compliant: Yes

PROCESSING

Lead-Free Solderable: Yes

SMT Lead Coplanarity:

-MT & -DV Tail Option: (0.10 mm) .004" max (02-25)

-MT & -DH Tail Option: (0.15 mm) .006" max (26-50)*
*(.004" stencil solution may be available; contact IPG@samtec.com)

RECOGNITIONS

For complete scope of recognitions see www.samtec.com/quality



ALSO AVAILABLE (MOQ Required)

- Molded Pick & Place pads
- Latches
- Other platings

Notes:

Some sizes, styles and options are non-standard, non-returnable.

See SFM/TFM for positive alignment feature.

Board Mates: CLP, FLE

Cable Mates: FFSD, FFTP

APPLICATIONS



HORIZONTAL

OPTIONS

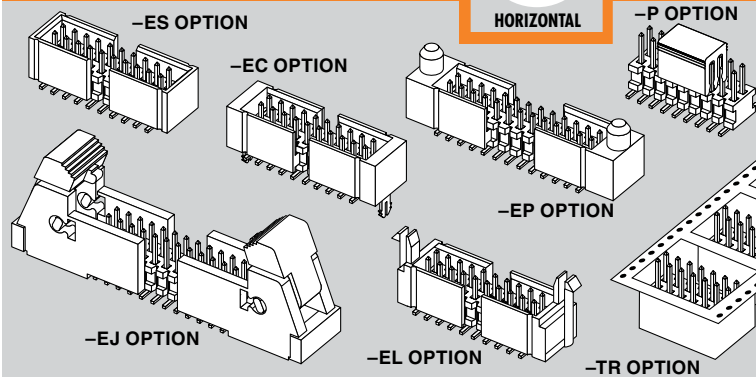

OTHER SOLUTIONS

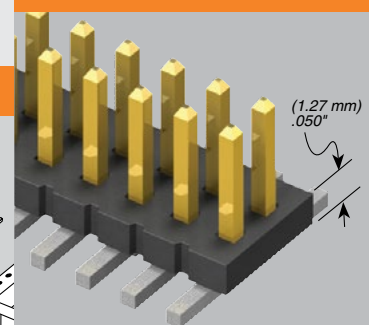

Ultra-low profile option available. End Shrouds available. Call for FTS Series specifications.

FTSH

1

NO. PINS PER ROW

LEAD STYLE

02 thru 50

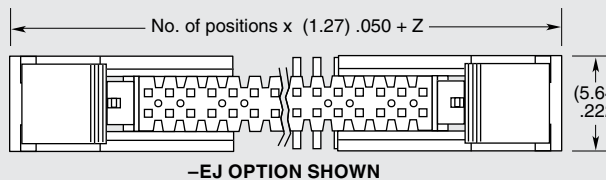
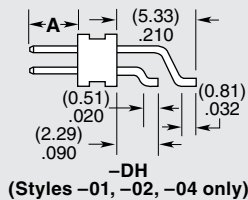
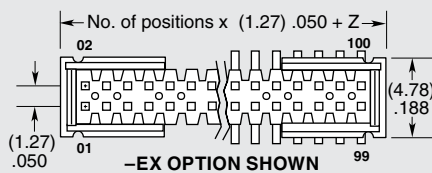

OPTION	Z
-ES	(2.57) .101
-EJ	(15.77) .621
-EC	(3.33) .131
-EP	(5.87) .231
-EL	(6.53) .257

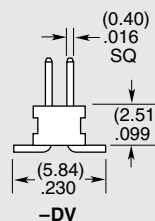
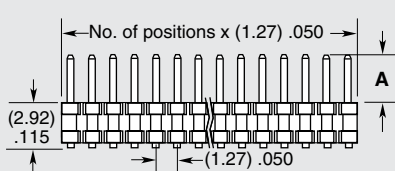

- 01**
= (3.05 mm) .120" Post
(Mates with FFSD, CLP-DH)
- 02**
= (1.91 mm) .075" Post
(Mates with FLE)
- 03**
= (1.65 mm) .065" Post
(Mates with CLP-D)
- 04**
= (3.81 mm) .150" Post
- 05**
= (4.32 mm) .170" Post
(Mates with CLP-BE)

LEAD STYLE	A
-01	(3.05) .120
-02	(1.91) .075
-03	(1.65) .065
-04	(3.81) .150
-05	(4.32) .170

Due to technical progress, all designs, specifications and components are subject to change without notice.

WWW.SAMTEC.COM

All parts within this catalog are built to Samtec's specifications. Customer specific requirements must be approved by Samtec and identified in a Samtec customer-specific drawing to apply.



FTSH-117-02-L-DV

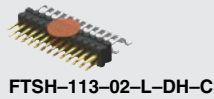

FTSH-113-02-L-DH-C

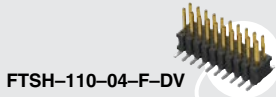

FTSH-110-04-F-DV



FTSH-112-03-L-DV-EP-P

FTSH-150-02-L-DV-EP

FTSH SERIES

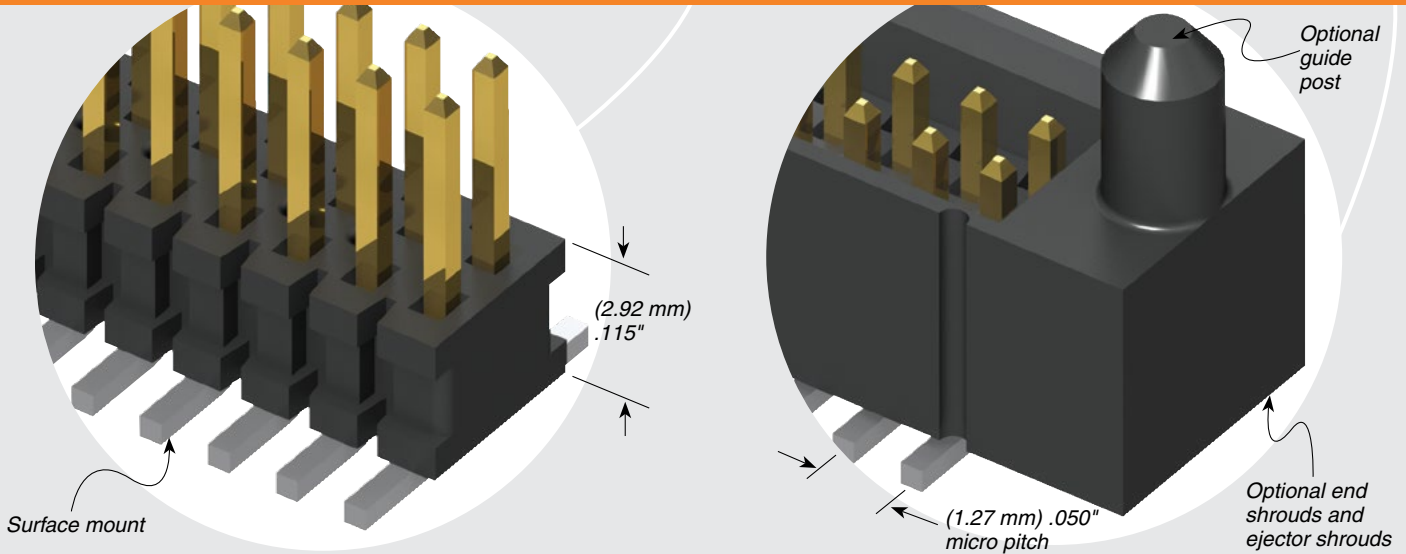

PLATING OPTION

- F**
= Gold flash on post, Matte Tin on tail
- L**
= 10 μ" (0.25 μm) Gold on post, Matte Tin on tail

TAIL OPTION

- DV**
= Double Vertical
- DH**
= Double Horizontal (Styles -01, -02 & -04 only)
- MT**
= Mixed Technology (Styles -01, -02 & -04 only)

OPTION

- Leave Blank for -DH & -MT
- “XXX”**
= Polarized Position (Specify position of omitted pin) (Not available with -EX options)

FLEX SHROUD OPTIONS

(Style -02 & -03 only, -DH & -MT not available)
9 pins/row minimum
(Other positions available. Call Samtec.)

- ES**
= End Shroud

- EC**
= End Shroud with Locking Clip (Manual placement required)

- EP**
= End Shroud with Guide Post

- EL**
= End Shroud with Board Lock (Boards are positively locked and cannot be unmated)

- EJ**
= Ejector Shroud (Style -01 only)
-DH & -MT not available
10 pins/row minimum
25 pins/row maximum

OTHER OPTIONS

- K**
= Keying Shroud (For mating with FFSD Style -01 only and 05, 08, 10, 13, 15, 17, 20 & 25 pins/row only. 13, 17, 20 & 25 pins/row only with -EJ option) (-DV only)

- A**
= Alignment Pin (-DV 3 positions min.) (-DH 5 positions min.) (Metal or plastic at Samtec discretion)

- C**
= (5.00 mm) .197" DIA Polyimide film Pick & Place Pad (-DH only)

- P**
= Pick & Place Pad (-DV 4 positions min.) (-DH & -MT not available)

- TR**
= Tape & Reel Packaging (Flex Shroud options not available except -ES & -EJ)

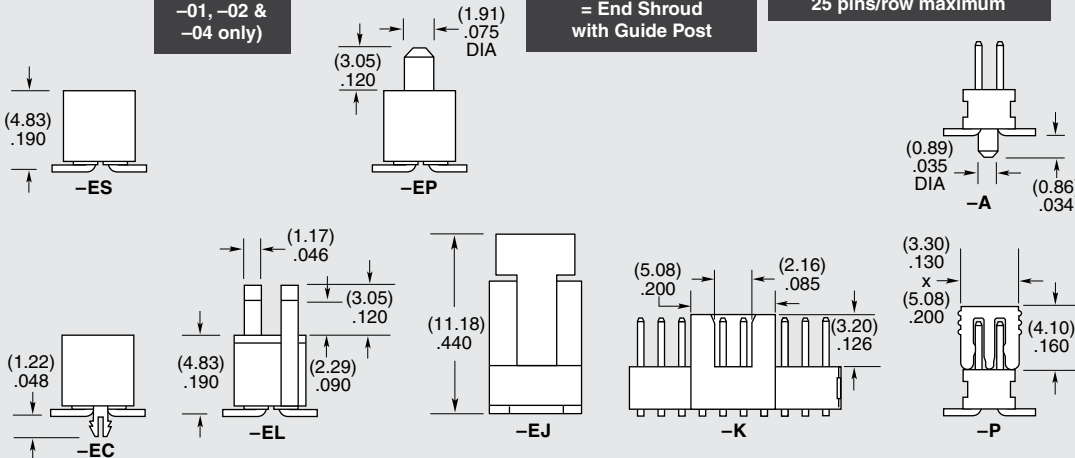

Due to technical progress, all designs, specifications and components are subject to change without notice.

WWW.SAMTEC.COM

All parts within this catalog are built to Samtec's specifications.
Customer specific requirements must be approved by Samtec and identified in a Samtec customer-specific drawing to apply.