

DO NOT SCALE FROM THIS PRINT

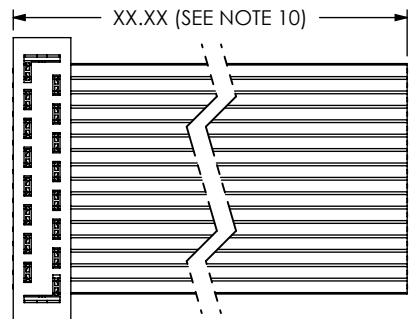

**FIG 2**  
HCSD-08-S-XX.XX-01 SHOWN  
(DIFFERENT AS SHOWN, OTHERWISE SAME AS FIG 1)

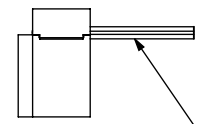

CB-XX-28-7/36-050-G

**FIG 3**  
-G: GRAY CABLE  
(DIFFERENT AS SHOWN, OTHERWISE SAME AS FIG 1)

HCSD-XX-X-XX.XX-01-XXX-XXX

No OF POSITIONS  
-02 THRU -36  
(STANDARD COLOR CODED CABLE)  
(-32 & -36 ONLY AVAILABLE WITH -G OPTION)  
(POSITIONS 21-36: EXISTING CUSTOMERS ONLY)

OPTION #2  
(SEE FIG 3 THRU FIG 19 FOR AVAILABLE OPTIONS)

OPTION #1  
(SEE FIG 3 THRU FIG 19 FOR AVAILABLE OPTIONS)

LEAD STYLE

ASSEMBLY LENGTH  
(2 INCH MINIMUM)

END ASSEMBLY  
-S: SINGLE END  
-D: DOUBLE END

-T: BRIGHT ACID TIN ON ENTIRE PIN  
(USE HCSD-XX-01-TX)  
LEAVE BLANK FOR 10μ" SELECTIVE GOLD IN CONTACT AREA, BRIGHT ACID TIN ON TAIL.

**FIG 4**  
-T: TIN PLATING

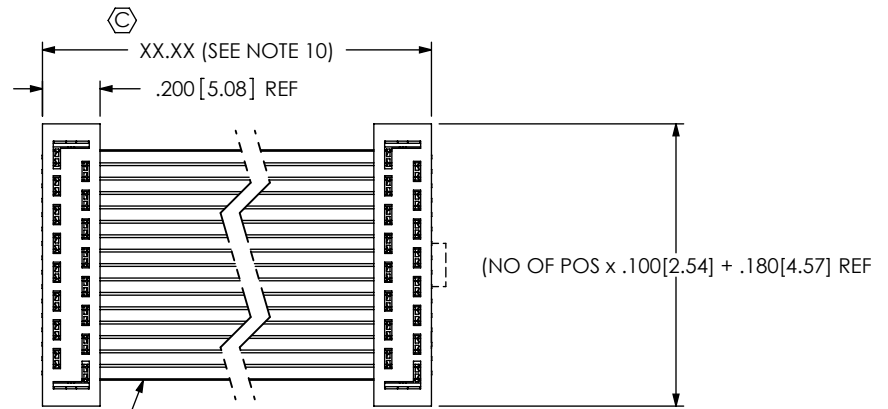

BROWN OR RED WIRE INDICATES POS #1  
CB-XX-28-7/36-050-C  
.010 [0.25] MAX CABLE OVERHANG (TYP)

.375 [9.53] REF (SEE NOTE 5)

HCSD-XX-01-X

NOTCH DENOTES FIRST POSITION (SEE NOTE 8)

**FIG 1**  
HCSD-08-D-XX.XX-01 SHOWN

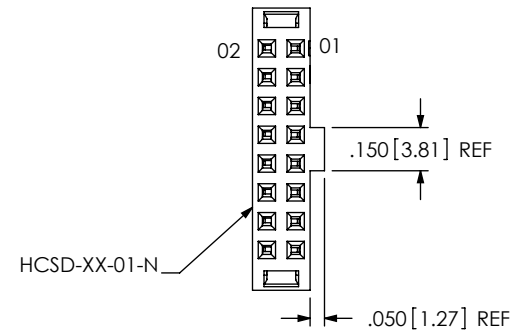

HCSD-XX-01-N

**FIG 5**  
-N: NOTCH  
(NOT AVAILABLE ON -02 POSITION)  
(DIFFERENT AS SHOWN, OTHERWISE SAME AS FIG 1)

NOTES:

1. Ⓢ REPRESENTS A CRITICAL DIMENSION.
2. HIDDEN LINES ARE USED TO SHOW POLARIZATION WHEN USING -N OPTION.
3. ALL ASSEMBLIES TO BE 100% ELECTRICALLY TESTED FOR SHORTS AND OPENS
4. ALL ASSEMBLIES TO BE 100% HI-POT TESTED AT 1000V.
5. HCSD-XX-01-X TO BE PRESSED TOGETHER WITH NO GAPS BETWEEN CABLE & BODIES.
6. CONDUCTORS SHALL BE CONSISTENT IN APPEARANCE, SOLDER MUST MAINTAIN CABLE STRANDS WITHIN THE MAX DIA. TOLERANCE.
7. NOTE DELETED.
8. FOR R OR RW OPTION, CABLE RIB ORIENTATION CAN BE EITHER TOWARDS OR AWAY FROM THE CAP.
9. WHEN CUTTING CABLE TO LENGTH, CONDUCTORS SHOULD NOT EXTEND PAST THE CABLE INSULATION, EXTENDING LESS THAN 25% OF CABLE THICKNESS ON CONSECUTIVE AND LESS THAN 50% OF THE CABLE THICKNESS ON NON-CONSECUTIVE STRANDS IS CONSIDERED A PROCESS INDICATOR.
10. FOR LENGTHS LESS THAN 12.5", TOLERANCE SHALL BE ±.125[3.18], ALL OTHER LENGTHS SHALL BE ±1%.

UNLESS OTHERWISE SPECIFIED, DIMENSIONS ARE IN INCHES.  
TOLERANCES ARE:  
DECIMALS ANGLES  
.XX: ±.01 [.3] 1°  
.XXX: ±.005 [.13]  
.XXXX: ±.0020 [.051]

**PROPRIETARY NOTE**  
THIS DOCUMENT CONTAINS CONFIDENTIAL AND PROPRIETARY INFORMATION AND ALL DESIGN, MANUFACTURING, REPRODUCTION, USE, PATENT RIGHTS AND SALES RIGHTS ARE EXPRESSLY RESERVED BY SAMTEC, INC. THIS DOCUMENT SHALL NOT BE DISCLOSED, IN WHOLE OR PART, TO ANY UNAUTHORIZED PERSON OR ENTITY NOR REPRODUCED, TRANSFERRED OR INCORPORATED IN ANY OTHER PROJECT IN ANY MANNER WITHOUT THE EXPRESS WRITTEN CONSENT OF SAMTEC, INC.

**MATERIAL:** DO NOT SCALE DRAWING SHEET SCALE: 3:2  
INSULATOR: LCP, UL 94 VO, COLOR: BLACK  
CONTACT: PHOS BRONZE  
CABLE: COLOR-CODED OR GRAY PVC/TIN PLATED COPPER

**samtec**  
520 PARK EAST BLVD, NEW ALBANY, IN 47150  
PHONE: 812-944-6733 FAX: 812-948-5047  
e-Mail: info@SAMTEC.com code 55322

DESCRIPTION: .100 CL MOLD TO POS DOUBLE ROW FEMALE ASSEMBLY

DWG. NO. HCSD-XX-X-XX.XX-01-XXX-XXX

BY: KOLB 08/03/1990 SHEET 1 OF 4

REVISION AC

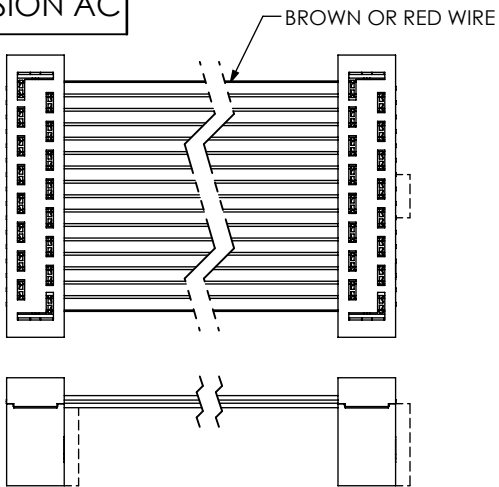

FIG 6

-RW: REVERSE WIRING  
(DIFFERENT AS SHOWN, OTHERWISE SAME AS FIG1)

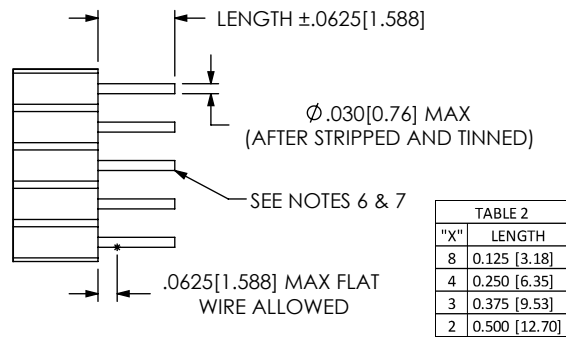

FIG 7

-ST"X": STRIPPED AND TINNED  
(DIFFERENT AS SHOWN, OTHERWISE SAME AS FIG1)  
(NOT AVAILABLE IN 28 POS AND UP)

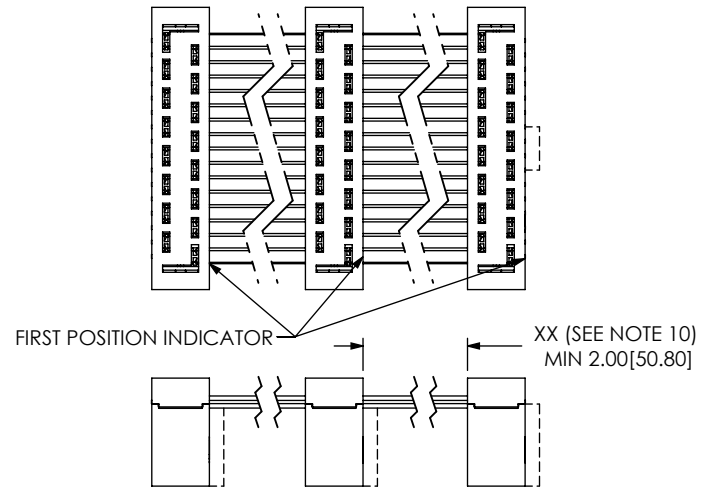

FIG 8

-D"XX": DAISY CHAIN DOUBLE  
(DIFFERENT AS SHOWN, OTHERWISE SAME AS FIG1)  
(2 INCH MIN WITH 1 INCH INCREMENTS)

BOTH SOCKETS REVERSED  
WHEN DAISY CHAINED

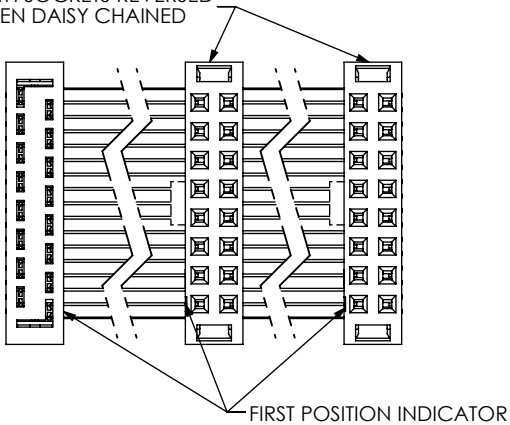
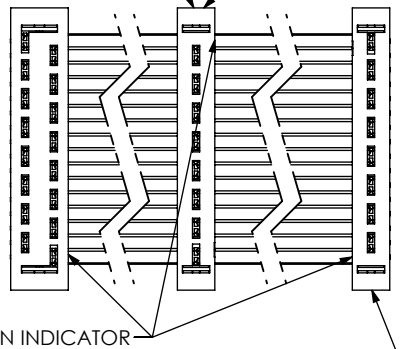

FIG 9

-R: REVERSE CONNECTOR  
(DIFFERENT AS SHOWN, OTHERWISE SAME AS FIG1)

MIDDLE SINGLE TO TERMINATE  
TO CONDUCTOR #1



END SINGLE TO TERMINATE  
TO CONDUCTOR #2

FIG 10

-W"XX": WIRING REVERSED  
(DIFFERENT AS SHOWN, OTHERWISE SAME AS FIG1)

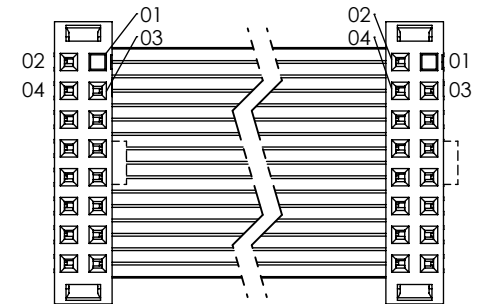

FIG 11

-P"XX": POLARIZED MATING  
(DIFFERENT AS SHOWN, OTHERWISE SAME AS FIG1)  
XX = POSITION NO  
INSERT POLARIZING KEY PART NO PK-06-N  
INTO SPECIFIED POSITION -XX (BOTH ENDS)

PROPRIETARY NOTE

THIS DOCUMENT CONTAINS CONFIDENTIAL AND PROPRIETARY INFORMATION AND ALL DESIGN, MANUFACTURING, REPRODUCTION, USE, PATENT RIGHTS AND SALES RIGHTS ARE EXPRESSLY RESERVED BY SAMTEC, INC. THIS DOCUMENT SHALL NOT BE DISCLOSED, IN WHOLE OR PART, TO ANY UNAUTHORIZED PERSON OR ENTITY NOR REPRODUCED, TRANSFERRED OR INCORPORATED IN ANY OTHER PROJECT IN ANY MANNER WITHOUT THE EXPRESS WRITTEN CONSENT OF SAMTEC, INC.



520 PARK EAST BLVD, NEW ALBANY, IN 47150  
PHONE: 812-944-6733 FAX: 812-948-5047  
e-Mail info@SAMTEC.com code 55322

DO NOT SCALE DRAWING

SHEET SCALE: 3:2

DESCRIPTION: .100 CL MOLD TO POS DOUBLE  
ROW FEMALE ASSEMBLY

DWG. NO.  
HCSD-XX-X-XX.XX-01-XXX-XXX

BY: KOLB 08/03/1990 SHEET 2 OF 4

END SINGLE TO TERMINATE  
TO CONDUCTOR #2

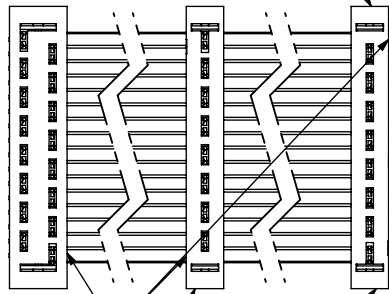

FIRST POSITION INDICATOR  
MIDDLE SINGLE TO TERMINATE  
TO CONDUCTOR #1

HCSS-XX-01-X

XX (SEE NOTE 10)  
MIN 2.00[50.80]

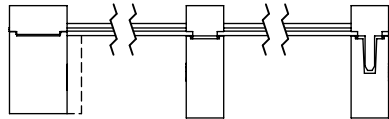
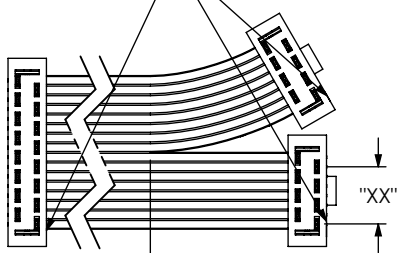

FIG 12

-S"XX": DAISY CHAIN SINGLE  
(SAME AS FIG 1, DIFFERENT AS SHOWN)  
2 INCH MIN WITH 1 INCH INCREMENTS  
SCALE: 3:2

FIRST POSITION INDICATOR



5.000[127.00] MAX  
2.000[50.80] MIN

FIG 15

-BXX: BREAKOUT OPTION  
(SAME AS FIG 1, DIFFERENT AS SHOWN)  
"XX" = NO OF CONDUCTORS BROKEN  
OUT FROM THE FIRST POSITION  
(HCSD-08-XX.XX-01-N-B04 SHOWN)

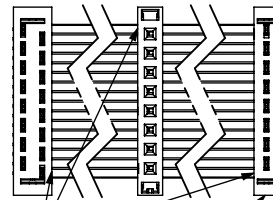

FIRST POSITION INDICATOR

HCSS-XX-01-X

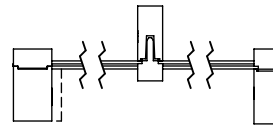
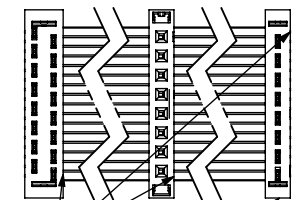

FIG 13

-W"XX"-M: MIDDLE REVERSED  
(SAME AS FIG 1, DIFFERENT AS SHOWN)



FIRST POSITION INDICATOR

HCSS-XX-01-X

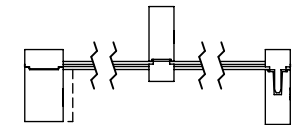
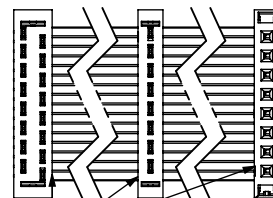

FIG 14

-S"XX"-M: MIDDLE REVERSED  
(SAME AS FIG 1, DIFFERENT AS SHOWN)



FIRST POSITION INDICATOR

HCSS-XX-01-X

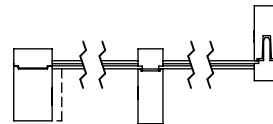
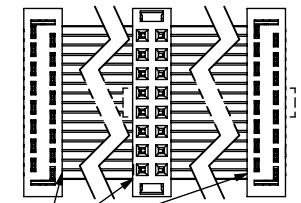

FIG 16

-S"XX"-O: OUTSIDE REVERSED  
(SAME AS FIG 1, DIFFERENT AS SHOWN)



FIRST POSITION INDICATOR

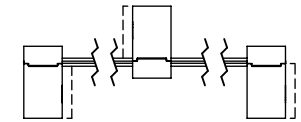

FIG 17

-D"XX"-M: MIDDLE REVERSED  
(SAME AS FIG 1, DIFFERENT AS SHOWN)

PROPRIETARY NOTE

THIS DOCUMENT CONTAINS CONFIDENTIAL AND PROPRIETARY INFORMATION AND ALL DESIGN, MANUFACTURING, REPRODUCTION, USE, PATENT RIGHTS AND SALES RIGHTS ARE EXPRESSLY RESERVED BY SAMTEC, INC. THIS DOCUMENT SHALL NOT BE DISCLOSED, IN WHOLE OR PART, TO ANY UNAUTHORIZED PERSON OR ENTITY NOR REPRODUCED, TRANSFERRED OR INCORPORATED IN ANY OTHER PROJECT IN ANY MANNER WITHOUT THE EXPRESS WRITTEN CONSENT OF SAMTEC, INC.



520 PARK EAST BLVD, NEW ALBANY, IN 47150  
PHONE: 812-944-6733 FAX: 812-948-5047  
e-Mail info@SAMTEC.com code 55322

DO NOT SCALE DRAWING

SHEET SCALE: 1:1

DESCRIPTION: .100 CL MOLD TO POS DOUBLE ROW FEMALE ASSEMBLY

DWG. NO. HCSD-XX-X-XX.XX-01-XXX-XXX

BY: KOLB 08/03/1990 SHEET 3 OF 4

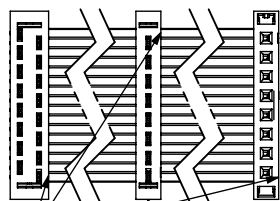

FIRST POSITION INDICATOR

HCSS-XX-01-X

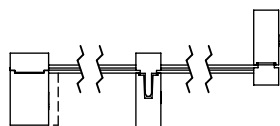
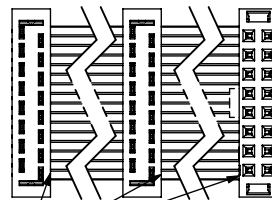

FIG 18

-W"XX"-O: OUTSIDE REVERSED  
(SAME AS FIG 1, DIFFERENT AS SHOWN)



FIRST POSITION INDICATOR

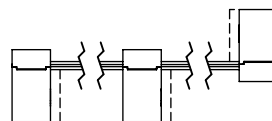

FIG 19

-D"XX"-O: OUTSIDE REVERSED  
(SAME AS FIG 1, DIFFERENT AS SHOWN)

PROPRIETARY NOTE

THIS DOCUMENT CONTAINS CONFIDENTIAL AND PROPRIETARY INFORMATION AND ALL DESIGN, MANUFACTURING, REPRODUCTION, USE, PATENT RIGHTS AND SALES RIGHTS ARE EXPRESSLY RESERVED BY SAMTEC, INC. THIS DOCUMENT SHALL NOT BE DISCLOSED, IN WHOLE OR PART, TO ANY UNAUTHORIZED PERSON OR ENTITY NOR REPRODUCED, TRANSFERRED OR INCORPORATED IN ANY OTHER PROJECT IN ANY MANNER WITHOUT THE EXPRESS WRITTEN CONSENT OF SAMTEC, INC.



520 PARK EAST BLVD, NEW ALBANY, IN 47150  
PHONE: 812-944-6733 FAX: 812-948-5047  
e-Mail info@SAMTEC.com code 55322

DO NOT SCALE DRAWING

SHEET SCALE: 1:1

DESCRIPTION: .100 CL MOLD TO POS DOUBLE ROW FEMALE ASSEMBLY

DWG. NO.  
HCSD-XX-X-XX.XX-01-XXX-XXX

BY: KOLB 08/03/1990 SHEET 4 OF 4