

DO NOT SCALE FROM THIS PRINT

DESIGNED & DIMENSIONED IN MILLIMETERS [INCHES]

QSFP-PF-XX-X

TERMINATION
-PF: PRESS FIT

STYLE
(LEAVE BLANK FOR STANDARD)
-F: FLYOVER (SEE NOTE 7)

OPTION

- 01: WITHOUT HEAT SINK
- 02: WITH HEAT SINK ASSEMBLED (SEE NOTE 4)
- 03: WITH HEAT SINK AND CLIP PACKAGED SEPARATELY

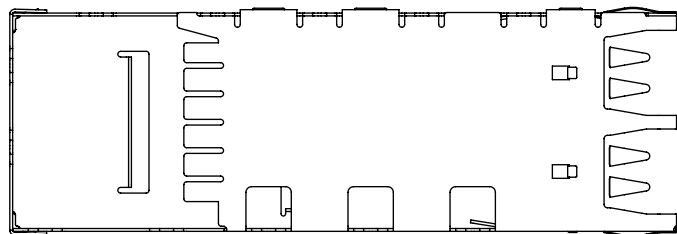
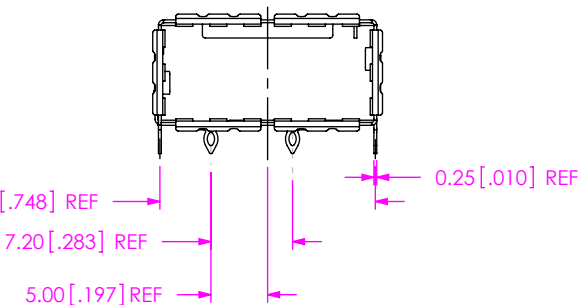
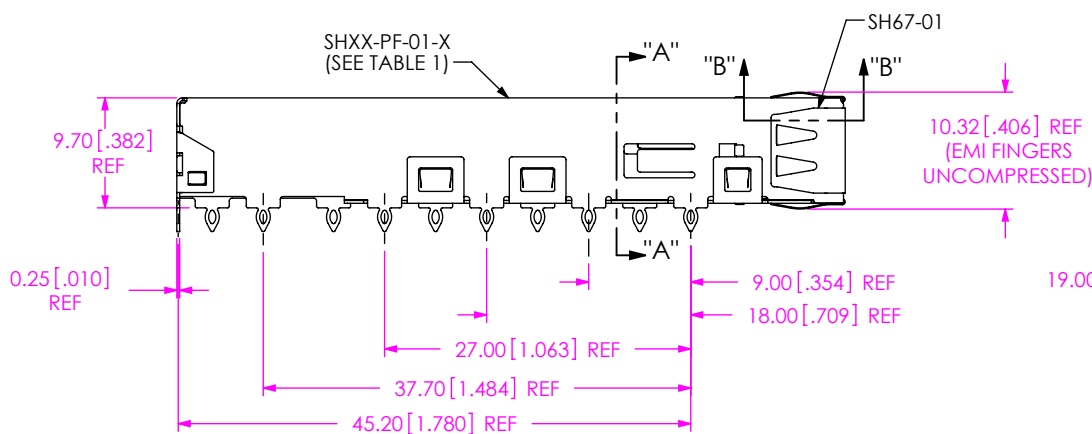
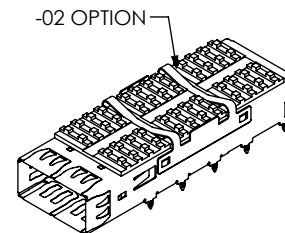
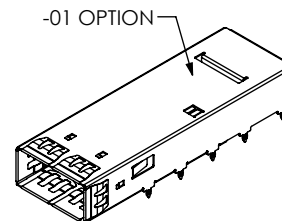
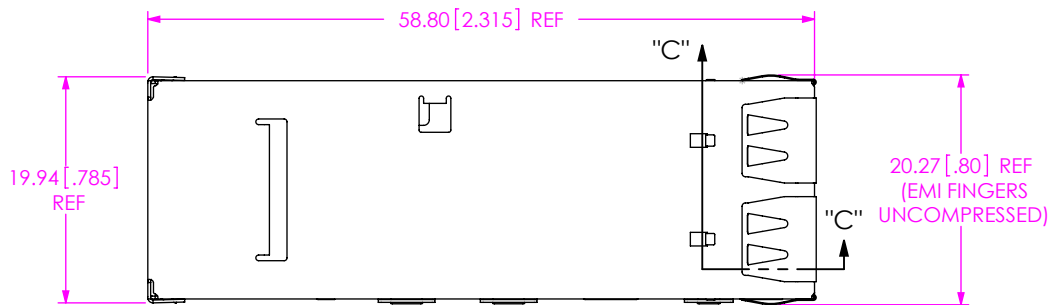

TABLE 1		
OPTION	STYLE	SHXX-PF-01-X
-01	STANDARD	SH59-PF-01-X
	-F	SH81-PF-01-X
-02	STANDARD	SH59-PF-02-X
	-F	SH81-PF-02-X
-03	STANDARD	SH59-PF-02-X
	-F	SH81-PF-02-X

NOTES:

1. © REPRESENTS A CRITICAL DIMENSION.
2. MINIMUM PUSHOUT FORCE: 1.11N [.25 LB]
3. OPTIONS -01 & -02 MUST BE PACKAGE IN TRAYS, FOR OPTION -03 CAGE MUST BE PACKAGED IN TRAYS, HEAT SINK AND SHIELD MUST BE PACKAGED IN TUBES.
4. HEAT SINK MUST BE REMOVED PRIOR TO TERMINATION TO PRINTED CIRCUIT BOARD.
5. SEE QSFP-PF APPLICATION FOR ADDITIONAL TERMINATION INSTRUCTIONS.
6. -F STYLE TO USE SAME TUBE & PLUG AS STANDARD.
7. -F STYLE USE FOR EXISTING CUSTOMERS ONLY.

FIG 1
QSFP-PF-01 SHOWN

UNLESS OTHERWISE SPECIFIED, DIMENSIONS ARE IN MILLIMETERS. TOLERANCES ARE:
DECIMALS ANGLES
X.X: ±0.3 [.01] 2°
X.XX: ±0.13 [.005]
X.XXX: ±0.051 [.0020]

PROPRIETARY NOTE
THIS DOCUMENT CONTAINS CONFIDENTIAL AND PROPRIETARY INFORMATION AND ALL DESIGN, MANUFACTURING, REPRODUCTION, USE, PATENT RIGHTS AND SALES RIGHTS ARE EXPRESSLY RESERVED BY SAMTEC, INC. THIS DOCUMENT SHALL NOT BE DISCLOSED, IN WHOLE OR PART, TO ANY UNAUTHORIZED PERSON OR ENTITY NOR REPRODUCED, TRANSFERRED OR INCORPORATED IN ANY OTHER PROJECT IN ANY MANNER WITHOUT THE EXPRESS WRITTEN CONSENT OF SAMTEC, INC.

MATERIAL: DO NOT SCALE DRAWING SHEET SCALE: 1.5:1

CAGE: COPPER ALLOY
CLIP: STAINLESS STEEL
EMI FINGERS: STAINLESS STEEL
HEAT SINK: ALUMINUM ALLOY

F:\DWG\MISC\MKTG\QSFP-PF-XX-X-MKT.SLDDRW



520 PARK EAST BLVD, NEW ALBANY, IN 47150
PHONE: 812-944-6733 FAX: 812-948-5047
e-Mail: info@SAMTEC.com code 53322

DESCRIPTION:	QSFP CAGE
DWG. NO.	QSFP-PF-XX-X
BY: VICKY Z	09/07/2010 SHEET 1 OF 4

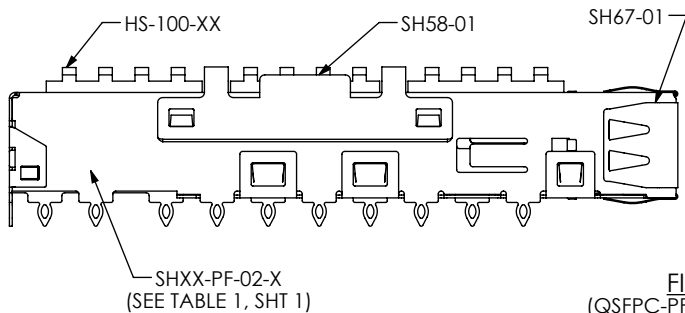
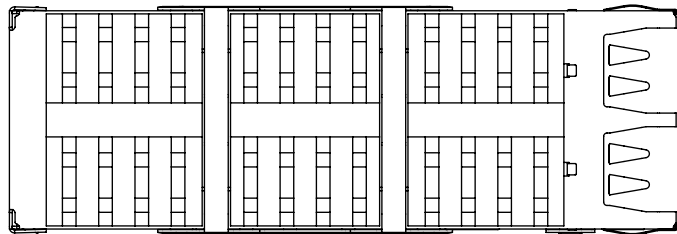
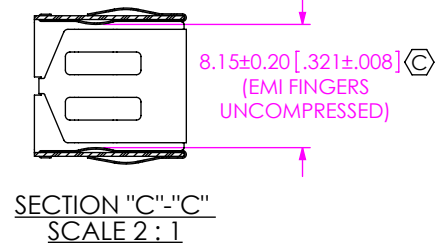
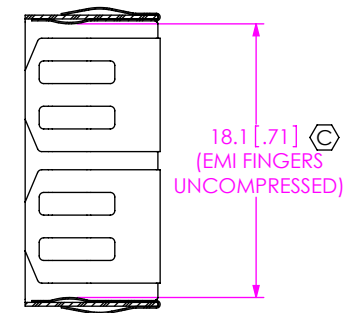
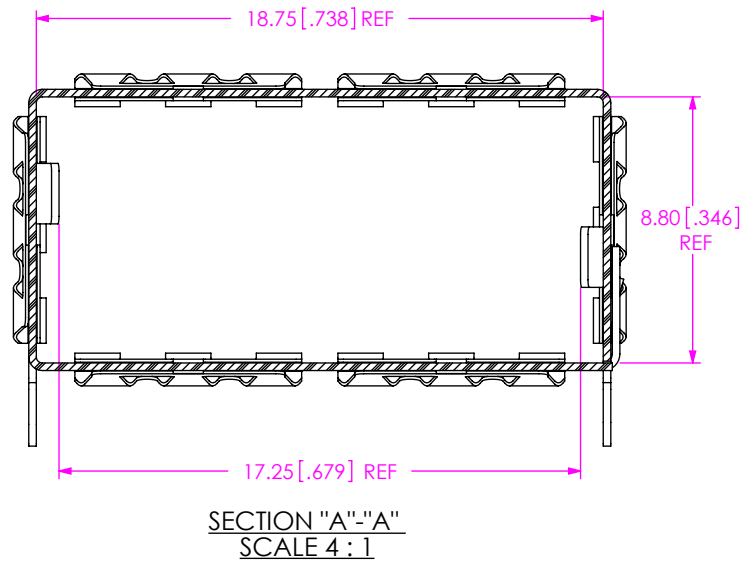
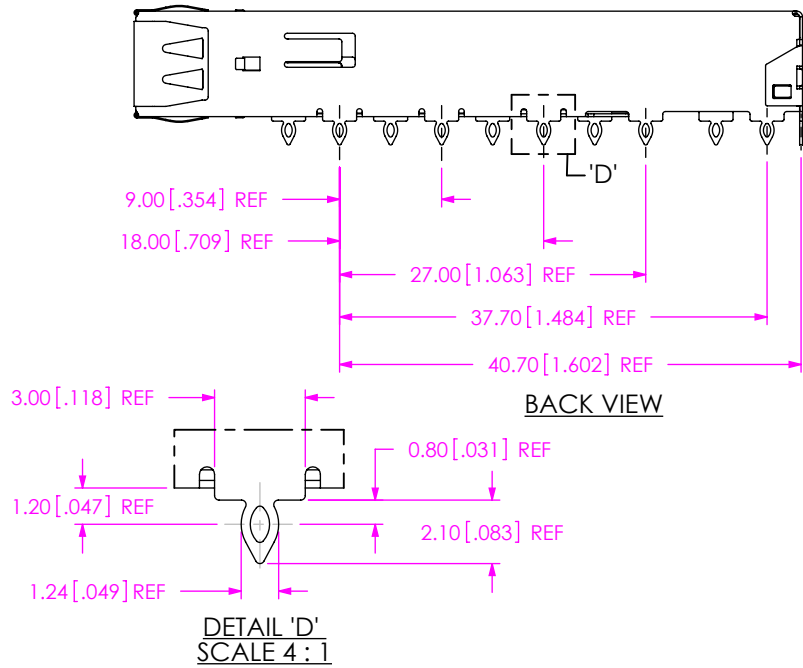
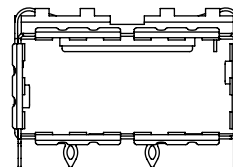

FIG 2
(QSFP-PF-02 SHOWN)
(SAME AS FIG 1, EXCEPT AS SHOWN)



PROPRIETARY NOTE
THIS DOCUMENT CONTAINS CONFIDENTIAL AND PROPRIETARY INFORMATION AND ALL DESIGN, MANUFACTURING, REPRODUCTION, USE, PATENT RIGHTS AND SALES RIGHTS ARE EXPRESSLY RESERVED BY SAMTEC, INC. THIS DOCUMENT SHALL NOT BE DISCLOSED, IN WHOLE OR PART, TO ANY UNAUTHORIZED PERSON OR ENTITY NOR REPRODUCED, TRANSFERRED OR INCORPORATED IN ANY OTHER PROJECT IN ANY MANNER WITHOUT THE EXPRESS WRITTEN CONSENT OF SAMTEC, INC.

DO NOT SCALE DRAWING

SHEET SCALE: 1.5:1

samtec

520 PARK EAST BLVD, NEW ALBANY, IN 47150
PHONE: 812-944-6733 FAX: 812-948-5047
e-Mail info@SAMTEC.com code 55322

DESCRIPTION:

QSFP CAGE

DWG. NO.

QSFP-PF-XX-X

BY: VICKY Z

09/07/2010

SHEET 2 OF 4

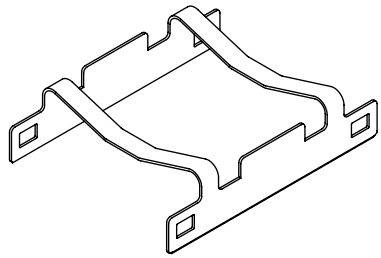

SH58-01

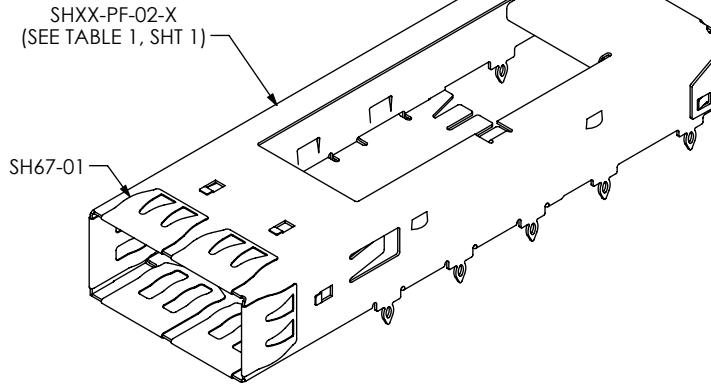

QSFP-CF-03

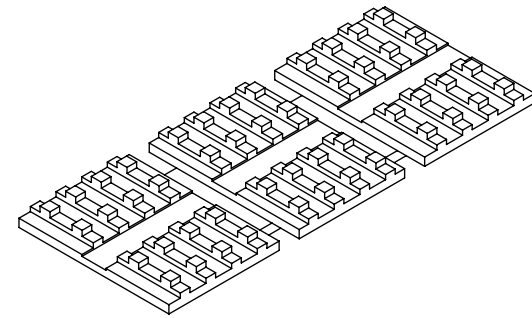

HS-100-01

FIG 3
(QSFP-CF-03 SHOWN)
(SAME AS FIG 1, EXCEPT AS SHOWN)

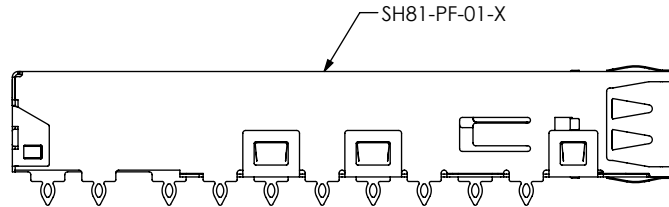
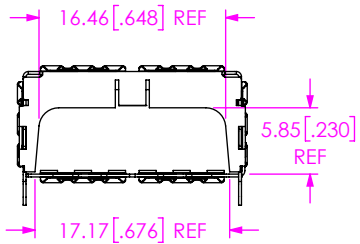
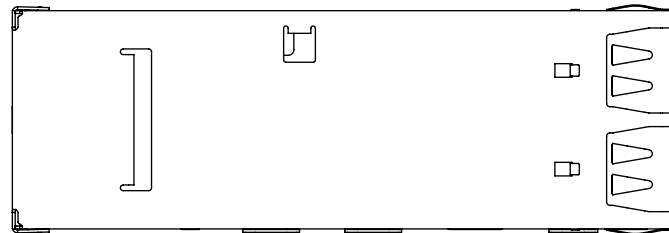

FIG 4
QSFP-CF-01-F SHOWN
(SAME AS FIG 1, EXCEPT AS SHOWN)
(SEE NOTE 6)

PROPRIETARY NOTE
THIS DOCUMENT CONTAINS CONFIDENTIAL AND PROPRIETARY INFORMATION AND ALL DESIGN, MANUFACTURING, REPRODUCTION, USE, PATENT RIGHTS AND SALES RIGHTS ARE EXPRESSLY RESERVED BY SAMTEC, INC. THIS DOCUMENT SHALL NOT BE DISCLOSED, IN WHOLE OR PART, TO ANY UNAUTHORIZED PERSON OR ENTITY NOR REPRODUCED, TRANSFERRED OR INCORPORATED IN ANY OTHER PROJECT IN ANY MANNER WITHOUT THE EXPRESS WRITTEN CONSENT OF SAMTEC, INC.

DO NOT SCALE DRAWING

SHEET SCALE: 1.5:1



520 PARK EAST BLVD, NEW ALBANY, IN 47150
PHONE: 812-944-6733 FAX: 812-948-5047
e-Mail info@SAMTEC.com code 55322

DESCRIPTION:

QSFP CAGE

DWG. NO.

QSFP-CF-XX-X

BY: VICKY Z

09/07/2010

SHEET 3 OF 4

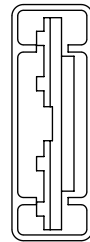

HEAT SINK
 HS-100-01
 (SEE NOTE 3)

TUBE: PT-1-24-14-29
 PLUG: TP-03

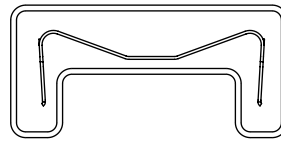

SHIELD
 SH58-01
 (SEE NOTE 3)

TUBE: PT-1-24-01-34
 PLUG: TP-07

PACKAGING VIEWS

PROPRIETARY NOTE
 * THIS DOCUMENT CONTAINS CONFIDENTIAL AND PROPRIETARY INFORMATION AND ALL DESIGN, MANUFACTURING, REPRODUCTION, USE, PATENT RIGHTS AND SALES RIGHTS ARE EXPRESSLY RESERVED BY SAMTEC, INC. THIS DOCUMENT SHALL NOT BE DISCLOSED, IN WHOLE OR PART, TO ANY UNAUTHORIZED PERSON OR ENTITY NOR REPRODUCED, TRANSFERRED OR INCORPORATED IN ANY OTHER PROJECT IN ANY MANNER WITHOUT THE EXPRESS WRITTEN CONSENT OF SAMTEC, INC. *



520 PARK EAST BLVD, NEW ALBANY, IN 47150
 PHONE: 812-944-6733 FAX: 812-948-5047
 e-Mail info@SAMTEC.com code 55322

SHEET SCALE: 1.5:1

DESCRIPTION: QSFP CAGE

DWG. NO. QSFP-XX-X

BY: VICKY Z 09/07/2010 SHEET 4 OF 4