

DO NOT SCALE FROM THIS PRINT

NOTES:

1. Ⓢ REPRESENTS A CRITICAL DIMENSION.
2. MINIMUM PUSHOUT FORCE: .5 LB.
3. COPLANARITY: .004[0.10] = POS 05 THRU 26
.006[0.15] = POS 27 THRU 50
4. TUBE ALL POSITIONS. PARTS TO BE TUBED WITH NOTCH GOING WITH ARROW.
5. PINS CAN BE ORIENTED IN ANY DIRECTION; BOTH ROWS MUST FACE SAME WAY.
6. SEE NOTCH FOR PROPER ORIENTATION.
7. Ⓢ MAXIMUM PIN HEIGHT VARIATION: .003[0.08] FROM PIN TO PIN AND ROW TO ROW, MUST BE MEASURED BETWEEN ADJACENT PINS.
8. DUE TO HIGH AMOUNT OF INSERTION FORCE NEEDED, THE -LC OPTION IS NOT COMPATIBLE WITH AUTO PLACEMENT. SAMTEC RECOMMENDS MANUAL PLACEMENT FOR ALL ASSEMBLIES WITH THE -LC OPTION.
9. DIMENSION TO BE MEASURED AT BEND.

*DIMENSIONS N/A FOR -N OPTION

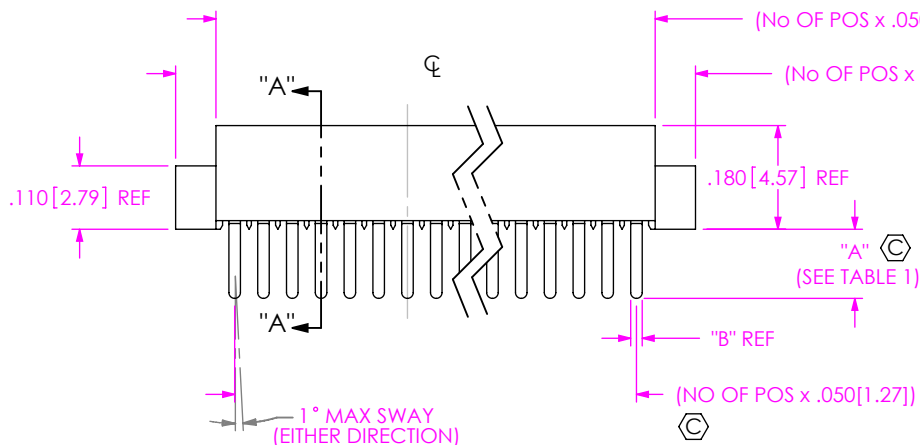
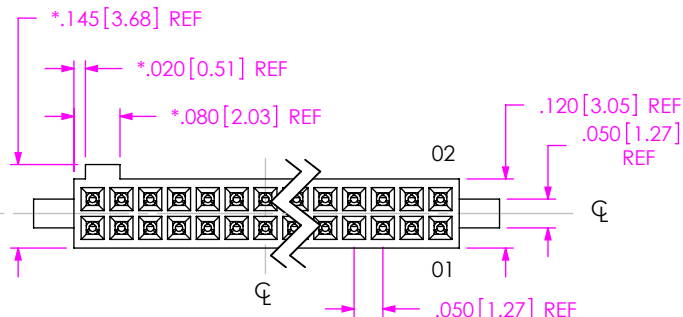

FIG 1 THROUGH HOLE/STRAIGHT MODIFIED

TABLE 1		
SUFFIX	TAIL LENGTH "A"	TAIL WIDTH "B"
-X1	.120[3.05]	.020[0.51]
-X3	.075[1.91]	.016[0.41]

ANY CHANGES MADE TO THIS PRINT MUST ALSO BE MADE TO THE SFC PRINT

SFM-1XX-XX-XXX-D-XXX

No OF POSITIONS
ALL POSITIONS AVAILABLE
-02 THRU -50
(USE BODY: SFM-XX-D-XX-X)

LEAD STYLE

- 01: THROUGH HOLE (USE CONTACT: C-44-01-XXX) (SEE FIG 1, SHT 1)
- 02: SURFACE MOUNT (USE CONTACT: C-44-02-XXX) (SEE FIG 2, SHT 2)
- 03: STRAIGHT MODIFIED (USE CONTACT: C-44-03-XXX) (SEE FIG 1, SHT 1)
- L1: THROUGH HOLE (LOW INSERTION) (USE CONTACT: C-61-01-XXX) (SEE FIG 1, SHT 1)
- L2: SURFACE MOUNT (LOW INSERTION) (USE CONTACT: C-61-02-XXX) (SEE FIG 2, SHT 2)
- L3: STRAIGHT MODIFIED (LOW INSERTION) (USE CONTACT: C-61-03-XXX) (SEE FIG 1, SHT 1)
- T1: THROUGH HOLE (PHOS BRONZE) (USE CONTACT: C-119-01-XXX) (SEE FIG 1, SHT 1)
- T2: SURFACE MOUNT (PHOS BRONZE) (USE CONTACT: C-119-02-XXX) (SEE FIG 2, SHT 2)

OPTIONS

- (LEAVE BLANK FOR STANDARD AND USE SFM-XX-D)
- N: NO POLARIZATION NOTCH (USE SFM-XX-D-XX-N)
- A: ALIGNMENT PIN (USE SFM-XX-D-A-X) (SEE FIG 4, SHT 2)
- LC: LOCKING CLIP (SEE FIG 6, SHT 3 & NOTE 8) (AVAILABLE ON ALL LEADS)
- P: PICK AND PLACE PAD (SEE FIG 5, SHT 2) (AVAILABLE ON 5 THRU 50 POSITION ONLY)
- TR: TAPE & REEL (SEE SHT 4) (NOT AVAILABLE WITH -DS OPTION)
- K: POLYIMIDE FILM PAD (.005[0.13] THICKNESS) (SEE FIG 3, SHT 2) (USE K-DOT-.157-.250-.005)
- SN: SOLDER NAIL FOR .062 BOARD (SFM-XX-D-SN AND WT-27-01-T) (AVAILABLE WITH LEAD STYLE -02, -L2 & -T2) (NOT AVAILABLE WITH -A & -LC)
- SN2: SOLDER NAIL FOR .093 BOARD (SFM-XX-D-SN AND WT-27-02-T) (AVAILABLE WITH LEAD STYLE -02, -L2 & -T2) (NOT AVAILABLE WITH -A & -LC)
- DS: DUAL SCREW DOWN FOR .062 BOARD (SEE FIG 8, SHT 3) (ONLY AVAILABLE WITH -01, -02 AND -03 LEAD STYLE) (NOT AVAILABLE WITH OPTIONS -N, -A, -LC, -P, -TR, -K, -SN AND SN2), (USES SFM-XX-D-DS, CPS-RR-XX-XX-X, ACCRT-01 AND WT-27-XX-T ALWAYS FILLED)

BODY SPECIFICATION

-D: DOUBLE ROW

PLATING SPECIFICATION

- S: 30 μ " SELECTIVE GOLD IN CONTACT AREA, MATTE TIN ON TAIL
- F: 3 μ " FLASH SELECTIVE GOLD IN CONTACT AREA, MATTE TIN ON TAIL
- H: 30 μ " HEAVY GOLD IN CONTACT AREA, 3 μ " GOLD ON TAIL
- L: 10 μ " LIGHT SELECTIVE GOLD IN CONTACT AREA, MATTE TIN ON TAIL
- STL: 30 μ " SELECTIVE GOLD IN CONTACT AREA, TIN/LEAD (90/10+/-5%) TAIL (ONLY AVAILABLE ON -02 OR -L2 LEADSTYLES)
- SM: 30 μ " SELECTIVE GOLD IN CONTACT AREA, MATTE TIN ON TAIL
- FM: 3 μ " FLASH SELECTIVE GOLD IN CONTACT AREA, MATTE TIN ON TAIL
- LM: 10 μ " LIGHT SELECTIVE GOLD IN CONTACT AREA, MATTE TIN ON TAIL

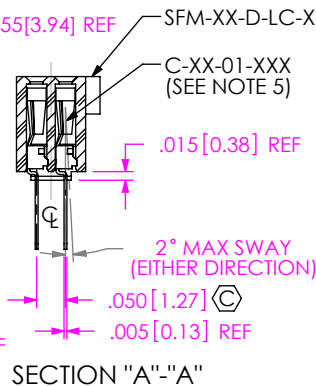

UNLESS OTHERWISE SPECIFIED, DIMENSIONS ARE IN INCHES.
TOLERANCES ARE:
DECIMALS ANGLES
.XX: $\pm .01$ [0.3] 2°
.XXX: $\pm .005$ [0.13]
.XXXX: $\pm .0020$ [0.051]

PROPRIETARY NOTE
THIS DOCUMENT CONTAINS CONFIDENTIAL AND PROPRIETARY INFORMATION AND ALL DESIGN, MANUFACTURING, REPRODUCTION, USE, PATENT RIGHTS AND SALES RIGHTS ARE EXPRESSLY RESERVED BY SAMTEC, INC. THIS DOCUMENT SHALL NOT BE DISCLOSED, IN WHOLE OR PART, TO ANY UNAUTHORIZED PERSON OR ENTITY NOR REPRODUCED, TRANSFERRED OR INCORPORATED IN ANY OTHER PROJECT IN ANY MANNER WITHOUT THE EXPRESS WRITTEN CONSENT OF SAMTEC, INC.

samtec
520 PARK EAST BLVD, NEW ALBANY, IN 47150
PHONE: 812-944-6733 FAX: 812-948-5047
e-Mail info@SAMTEC.com code 55322

DESCRIPTION:
.050 x .050 SOCKET STRIP DOUBLE ROW ASSEMBLY

DWG. NO.
SFM-1XX-XX-XXX-D-XXX

BY: JORDAN 12/11/89 SHEET 1 OF 4

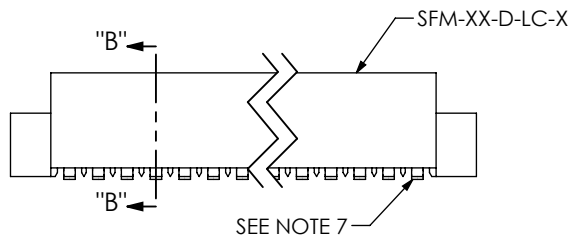
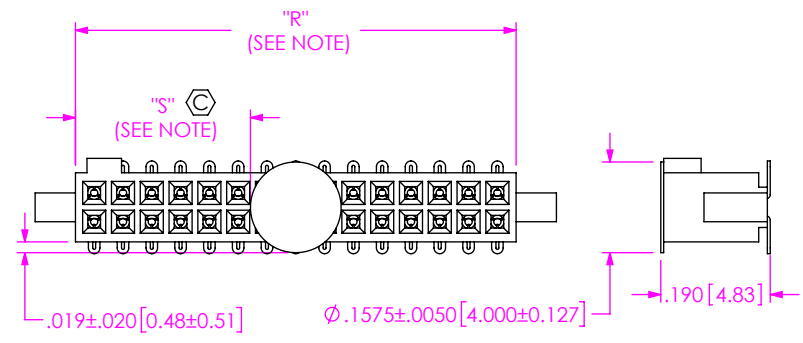
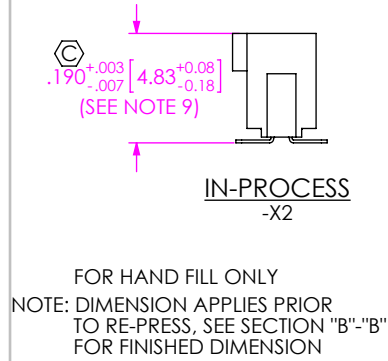
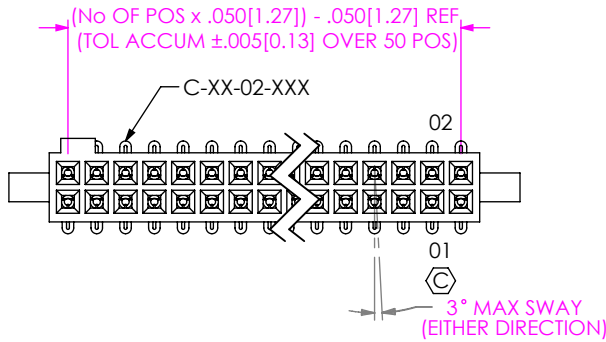

FIG 2
-X2: SURFACE MOUNT
(SAME AS FIG 1, DIFFERENT AS SHOWN)

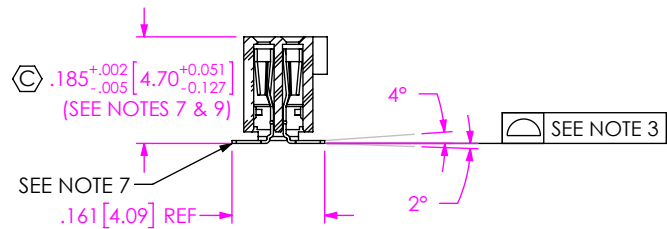
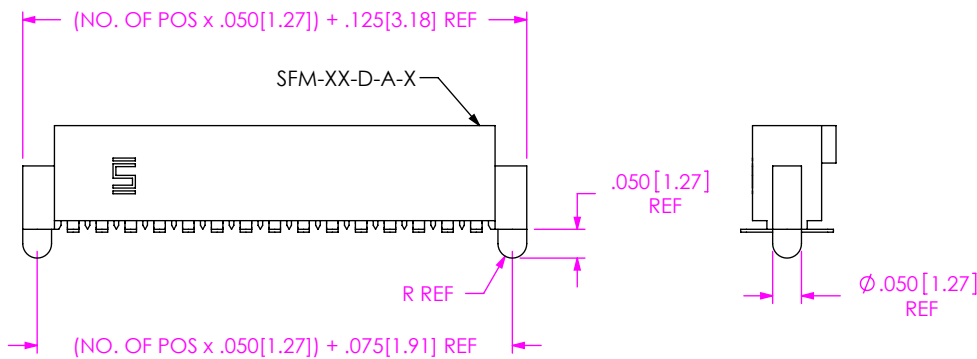
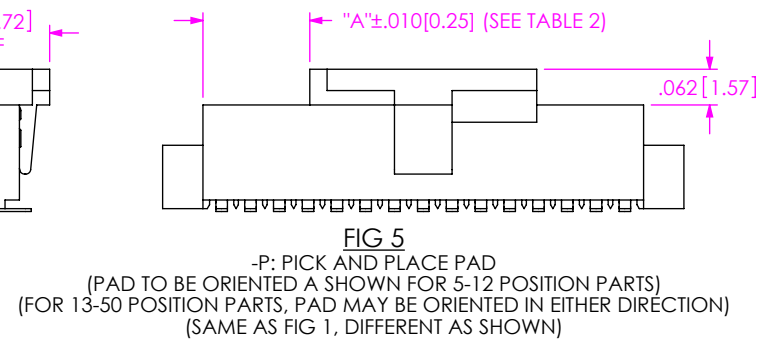
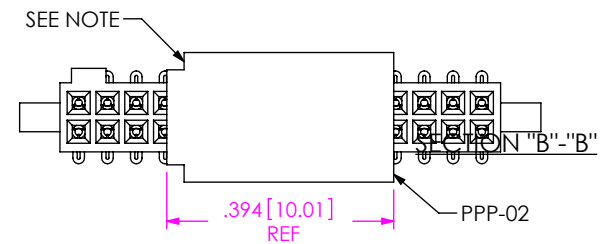

TABLE 2	
POS.	"A"
ODD	{(No. OF POS x .050[1.27])/2} - .1895[4.813]
EVEN	{(No. OF POS x .050[1.27])/2} - .2145[5.448]



PROPRIETARY NOTE
THIS DOCUMENT CONTAINS CONFIDENTIAL AND PROPRIETARY INFORMATION AND ALL DESIGN, MANUFACTURING, REPRODUCTION, USE, PATENT RIGHTS AND SALES RIGHTS ARE EXPRESSLY RESERVED BY SAMTEC, INC. THIS DOCUMENT SHALL NOT BE DISCLOSED, IN WHOLE OR PART, TO ANY UNAUTHORIZED PERSON OR ENTITY NOR REPRODUCED, TRANSFERRED OR INCORPORATED IN ANY OTHER PROJECT IN ANY MANNER WITHOUT THE EXPRESS WRITTEN CONSENT OF SAMTEC, INC.

DO NOT SCALE DRAWING
SHEET SCALE: 3:1



520 PARK EAST BLVD, NEW ALBANY, IN 47150
PHONE: 812-944-6733 FAX: 812-948-5047
e-Mail info@SAMTEC.com code 55322

DESCRIPTION:
.050 x .050 SOCKET STRIP DOUBLE ROW ASSEMBLY
DWG. NO.
SFM-1XX-XX-XXX-D-XXX
BY: JORDAN 12/11/89 SHEET 2 OF 4

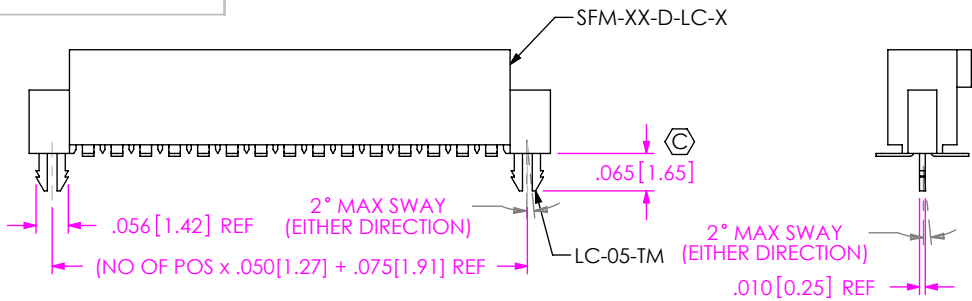

FIG 6
-LC: LOCKING CLIP
(SAME AS FIG 1, DIFFERENT AS SHOWN)
(AVAILABLE IN ALL LEADS)

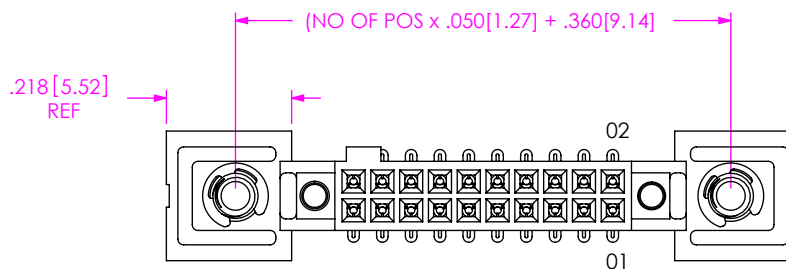

TABLE 4		
LEAD STYLE	"D"	WT-27
-01	.081	-01
-02	.081	-01
-03	.115	-02

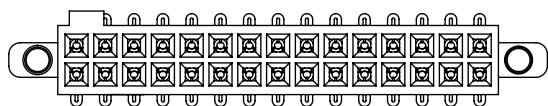
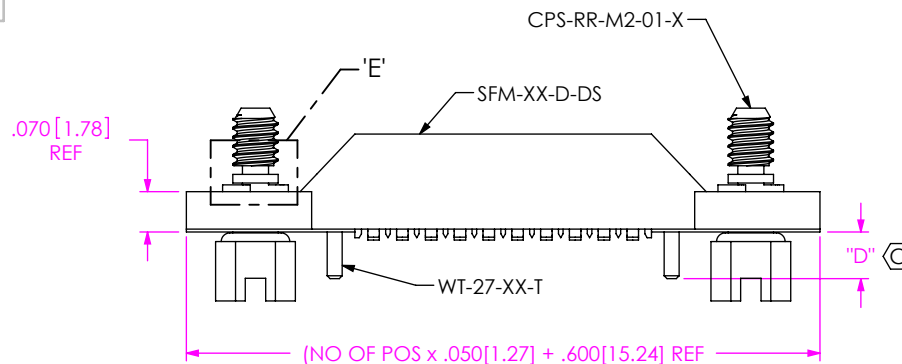
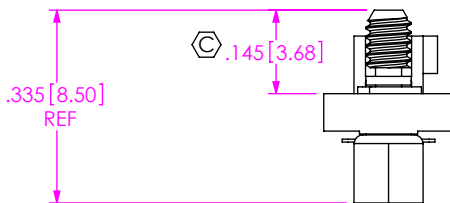

TABLE 3	
OPTION	"C"
-SN	.076 [1.93]
-SN2	.110 [2.79]

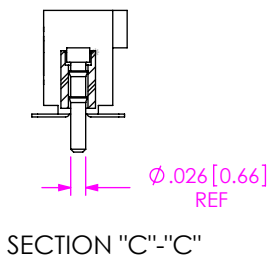
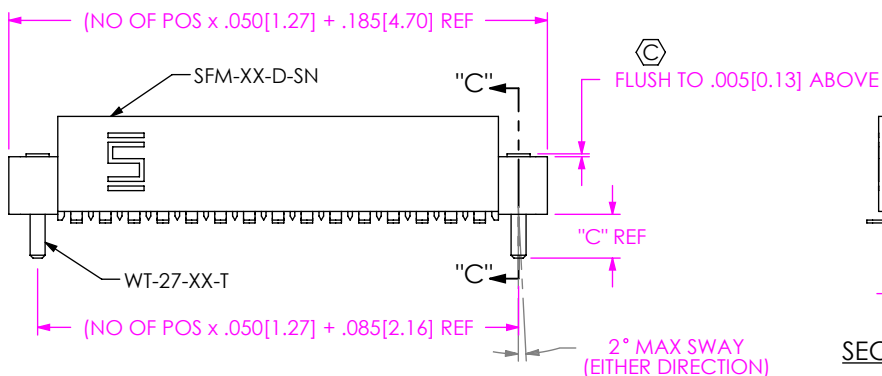

FIG 7
-SNX: SOLDER NAIL
(SAME AS FIG 1, DIFFERENT AS SHOWN)

F:\DWG\MISC\MKTG\SFM-1XX-XX-XXX-D-XXX-MKT.SLDDRW

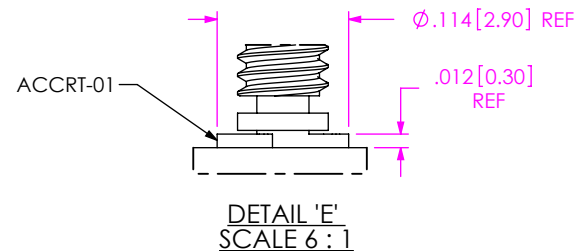

FIG 8
-DS: DUAL SCREW DOWN
(SAME AS FIG 2, DIFFERENT AS SHOWN)

PROPRIETARY NOTE
THIS DOCUMENT CONTAINS CONFIDENTIAL AND PROPRIETARY INFORMATION AND ALL DESIGN, MANUFACTURING, REPRODUCTION, USE, PATENT RIGHTS AND SALES RIGHTS ARE EXPRESSLY RESERVED BY SAMTEC, INC. THIS DOCUMENT SHALL NOT BE DISCLOSED, IN WHOLE OR PART, TO ANY UNAUTHORIZED PERSON OR ENTITY NOR REPRODUCED, TRANSFERRED OR INCORPORATED IN ANY OTHER PROJECT IN ANY MANNER WITHOUT THE EXPRESS WRITTEN CONSENT OF SAMTEC, INC.

DO NOT SCALE DRAWING
SHEET SCALE: 3:1



520 PARK EAST BLVD, NEW ALBANY, IN 47150
PHONE: 812-944-6733 FAX: 812-948-5047
e-Mail info@SAMTEC.com code 55322

DESCRIPTION:
.050 x .050 SOCKET STRIP DOUBLE ROW ASSEMBLY

DWG. NO. SFM-1XX-XX-XXX-D-XXX

BY: JORDAN 12/11/89 SHEET 3 OF 4

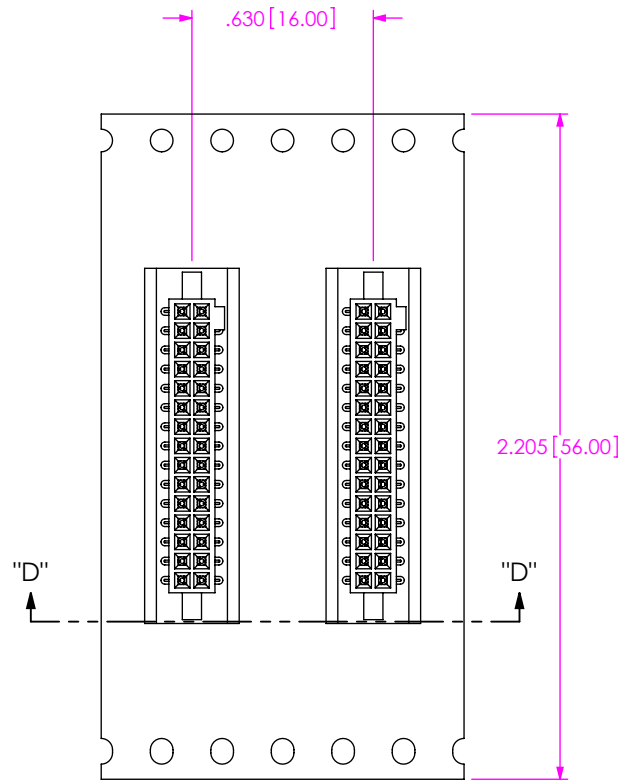

UNWINDING DIRECTION →

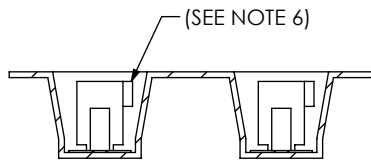

SECTION "D"-"D"
SCALE 2 : 1

PACKAGING VIEW
-TR: TAPE AND REEL

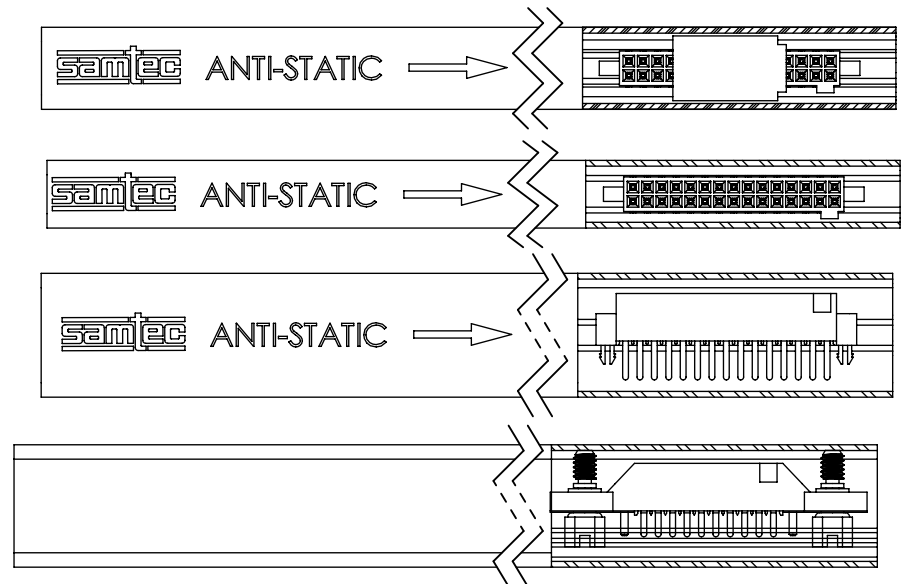
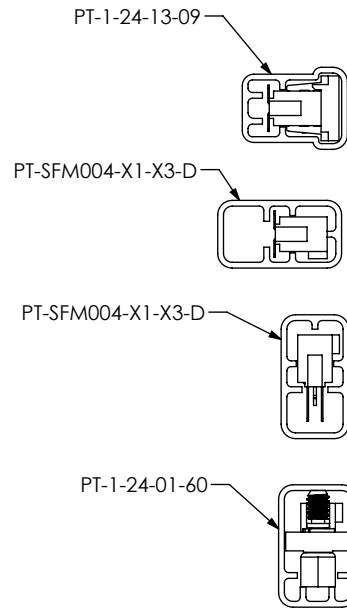

LEAD STYLE	PACKAGING TUBE	PLUG
-105-X2-X-D, -105X2-X-D-LC, -105-X2-D-A, -105-X2-D-K-LC, -105-X2-X-D-K, -105-X2-X-D-A-K	PT-1-24-14-09	TP-24-02
-X1-D, -X3-D, -X1-D-LC, -X3-D-LC, (NO P&P PAD), -X1-D-A, -X3-D-A, -X1-D-K, -X3-D-K, -X1-A-K, -X3-A-K -X1-D-P, -X1-D-LC-P (WITH P&P PAD), X1-D-A-P	PT-SFM004-X1-X3-D	TP-24-02
-X2-D, -X2-D-K, -X2-D-LC (NO P&P PAD), -X2-D-A, -X2-D-K-A, -X2-D-LC-K, -X2-D-SNX	PT-1-24-02-17	TP-09
-X2-D-P, -X3-D-P, -X2-D-LC-P (WITH P&P PAD), -X2-D-A-P, -X3-D-A-P, -X2-D-P-SNX	PT-SFM004-X1-X3-D	TP-24-02
-01-DS, -02-DS, -03-DS	PT-1-24-13-09	TP-24
	PT-1-24-01-60	TP-03

***FOR MACHINE LOADING OF TUBES FOR PARTS W/O PADS USE PT-1-24-14-09, TP-24-02**

5 POS -01 AND -03 LEAD STYLES MAY BE TUBED USING PT-1-24-15-09, TP-24-02
2 POS -X1 STYLE TO BE TUBED IN PT-1-24-15-09

PACKAGING VIEW
PACKAGE PARTS IN TUBES AS SHOWN (SEE NOTE 4)

F:\DWG\MISC\MKTG\SFM-1XX-XX-XXX-D-XXX-MKT.SLDDRW

PROPRIETARY NOTE
THIS DOCUMENT CONTAINS CONFIDENTIAL AND PROPRIETARY INFORMATION AND ALL DESIGN, MANUFACTURING, REPRODUCTION, USE, PATENT RIGHTS AND SALES RIGHTS ARE EXPRESSLY RESERVED BY SAMTEC, INC. THIS DOCUMENT SHALL NOT BE DISCLOSED, IN WHOLE OR PART, TO ANY UNAUTHORIZED PERSON OR ENTITY NOR REPRODUCED, TRANSFERRED OR INCORPORATED IN ANY OTHER PROJECT IN ANY MANNER WITHOUT THE EXPRESS WRITTEN CONSENT OF SAMTEC, INC.

DO NOT SCALE DRAWING

SHEET SCALE: 1:5:1



520 PARK EAST BLVD, NEW ALBANY, IN 47150
PHONE: 812-944-6733 FAX: 812-948-5047
e-Mail info@SAMTEC.com code 55322

DESCRIPTION:
.050 x .050 SOCKET STRIP DOUBLE ROW ASSEMBLY

DWG. NO.
SFM-1XX-XX-XXX-D-XXX

BY: JORDAN 12/11/89 SHEET 4 OF 4