



EZ-2P3-GT



SC-8P1-GG

SC, EZ SERIES

STANDARD, LOW PROFILE & SMT SOCKETS

**Specifications:
SC, EZ**

Contact:

BeCu

Shell:

Brass

-GG Plating:

30µ" (0,76 µm) Au over
50µ" (1,27 µm) Ni on contact;
10µ" (0,25 µm) Au over
50µ" (1,27 µm) Ni on shell

-GT Plating:

30µ" (0,76 µm) Au over
50µ" (1,27 µm) Ni on contact;
Sn over 50µ" (1,27 µm) Ni on shell

-TT Plating:

Sn over 50µ" (1,27 µm)
Ni on contact; Sn over 50µ"
(1,27 µm) Ni on shell

-ST Plating:

10µ" (0,25 µm) Au over
50µ" (1,27 µm) Ni on contact;
Sn over 50µ" (1,27µm)
Ni on shell

Contact Resistance:

10 mΩ

Insertion Force (SC):

9 oz (2,50 N) avg,
16 oz (4,45 N) max

16 oz (4,45 N) max

Withdrawal Force (SC):

2.5 oz (0,70 N) avg,
1.5 oz (0,42 N) min

Insertion Force (EZ):

2.5 oz (0,70 N) avg,
5.5 oz (1,53N) max

Withdrawal Force (EZ):

2.0 oz (0,56 N) avg,
0.35 oz (0,10 N) min

Lead DIA Accepted:

.015" to .022"
(0,38 mm to 0,56 mm) and
most IC leads

**RECOMMENDED
PC HOLE SIZE:**

LEAD SIZE	HOLE SIZE
(0,46) .018 DIA	(0,61) .024 DIA
(0,51) .020 DIA	(0,66) .026 DIA
(0,64) .025 DIA	(0,79) .031 DIA
(0,76) .030 DIA	(0,91) .036 DIA
(0,89) .035 DIA	(1,04) .041 DIA
(1,14) .045 DIA	(1,30) .051 DIA
(1,32) .052 DIA	(1,47) .058 DIA
(0,46) .018 SQ	(0,76) .030 DIA
(0,64) .025 SQ	(1,02) .040 DIA
(1,14) .045 SQ	(1,75) .069 DIA
(0,20) .008 x (0,71) .028	(0,89) .035 DIA
(0,25) .010 x (0,51) .020	(0,71) .028 DIA
(0,41) .016 x (0,51) .020	(0,79) .031 DIA
(0,41) .016 x (0,61) .024	(0,89) .035 DIA
(0,41) .016 x (0,79) .031	(1,04) .041 DIA

Note:

Some sizes, styles and options are non-standard, non-returnable.

**SC-1P1-, SC-6P1-,
EZ-1P1-, EZ-6P1-**

Part No.	X DIA	Y ±.010	Z ±.015
SC-1P1- EZ-1P1-	(0,51) .020	(3,18) .125	(7,62) .300
SC-6P1- EZ-6P1-	(0,51) .020	(4,57) .180	(8,89) .350

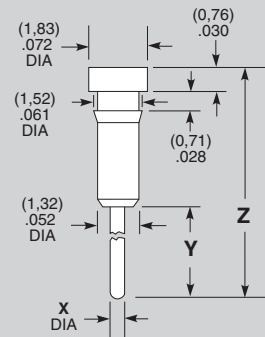

Insertion Depth (SC-1P1, SC-6P1) = .95" to .145" (2,41 mm to 3,68 mm)
Plating Available (SC-1P1) = GG, GT, TT, ST
Plating Available (SC-6P1) = GG, GT

EZ-2P3-

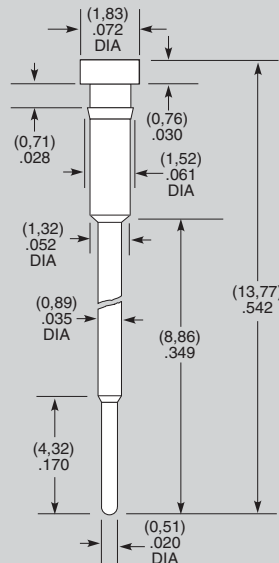

Insertion Depth = .125" to .170" (3,18 mm to 4,32 mm)
Plating Available = GG, GT

SC-1W1-, EZ-1W1-

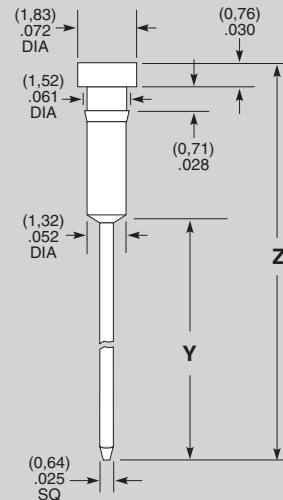

Insertion Depth = .125" to .157" (3,18 mm to 3,99 mm)
Plating Available = GG, GT, TT

Part No.	Y ±.010	Z ±.015
SC-1W1-XX-1 EZ-1W1-XX-1	(12,95) .510	(17,86) .703
SC-1W1-XX-2 EZ-1W1-XX-2	(9,14) .360	(14,05) .553
SC-1W1-XX-3 EZ-1W1-XX-3	(6,60) .260	(11,51) .453

Due to technical progress, all designs, specifications and components are subject to change without notice.

WWW.SAMTEC.COM



SC-1P4-GG



SC-8P1-GT

SC, EZ SERIES

STANDARD, LOW PROFILE & SMT SOCKETS

Specifications:

SC-1P4

Contact:

BeCu

Shell:

Brass

-GG Plating:

20µ" (0,51 µm) Au over 50µ" (1,27 µm) Ni on contact

-GT Plating:

20µ" (0,51 µm) Au over 50µ" (1,27 µm) Ni on contact

Contact Resistance:

10 mΩ

Insertion Force:

6.5 oz (1,81 N) avg,
13 oz (3,62 N) max
(.032" (0,81 mm) DIA probe)

Withdrawal Force:

3 oz (0,83 N) avg,
2 oz (0,56 N) min
(.032" (0,81 mm) DIA probe)

SC-5P1-

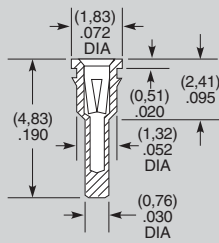

Insertion Depth = .080" to .150" (2,03 mm to 3,81 mm)
Lead DIA Accepted: .016" to .020" (0,41 mm to 0,51 mm)
Plating Available = GG, GT, TT

SC-3P1

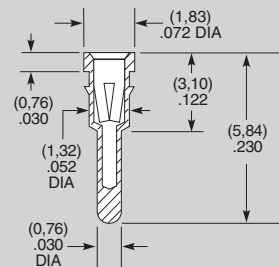

Insertion Depth = .105" to .170" (2,67 mm to 4,32 mm)
Lead DIA Accepted: .015" to .020" (0,38 mm to 0,51 mm)
Plating Available = GG, GT, TT

SC-4P1-, EZ-4P1-

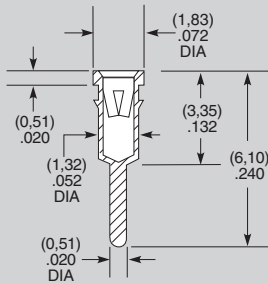

Insertion Depth = .080" to .105" (2,03 mm to 2,67 mm)
Lead DIA Accepted: .016" to .021" (0,41 mm to 0,53 mm)
Plating Available = GG, GT, TT

SC-1P4-

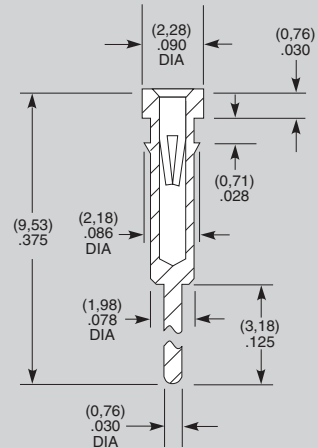

Insertion Depth = .175" to .215" (4,45 mm to 5,46 mm)
Lead DIA Accepted = .032" to .038" (0,81 mm to 0,97 mm)
Plating Available = GG, GT

SC-8P1-

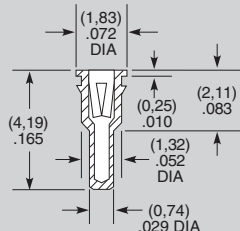

Insertion Depth = .085" to .140" (2,16 mm to 3,56 mm)
Lead DIA Accepted: .016" to .020" (0,41 mm to 0,51 mm)
Plating Available = GG, GT, TT

Note:
Some sizes, styles and options are non-standard, non-returnable.

Due to technical progress, all designs, specifications and components are subject to change without notice.

WWW.SAMTEC.COM