

DO NOT SCALE FROM THIS PRINT

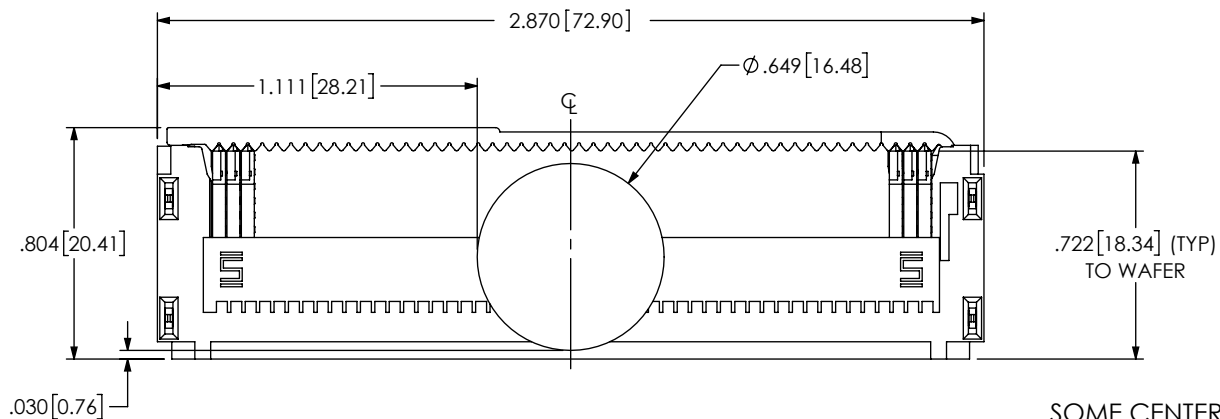

SOME CENTER FEATURES NOT SHOWN FOR CLARITY

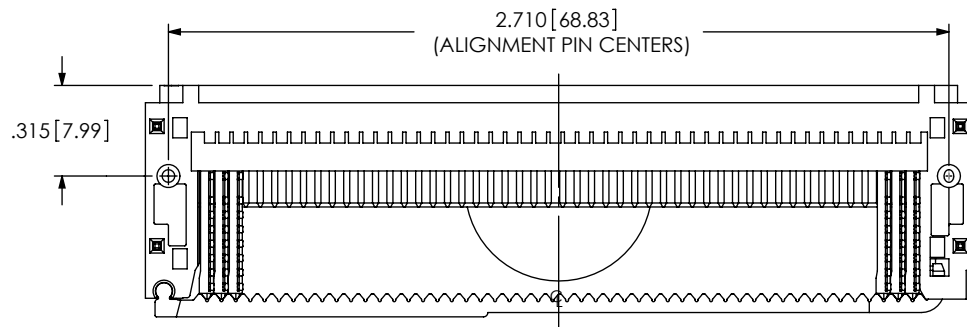
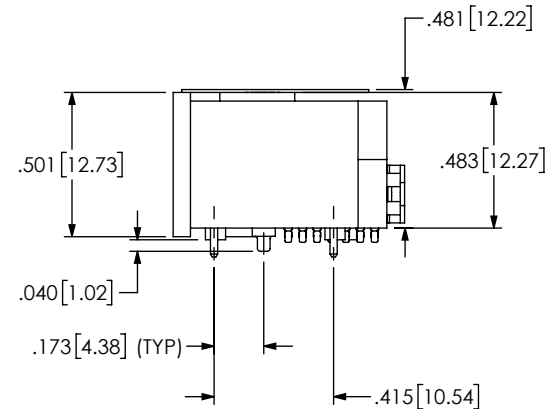
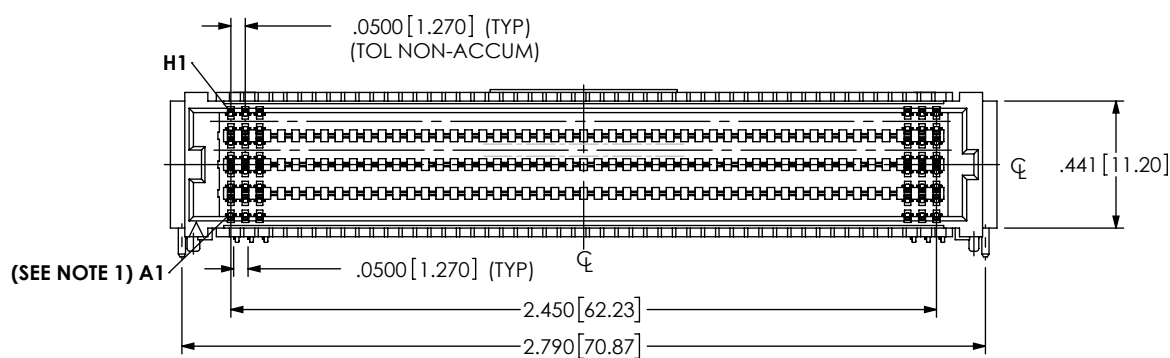

NOTES:

- ANSI/VITA 90 VNX+ INDUSTRY STANDARD COMPLIANT CONNECTOR FOR VNX+ APPLICATIONS. ATTENTION: CUSTOMIZED A1 PIN LOCATION FOR V90 APPLICATIONS. IMPORTANT: PCB LAYOUT ON SHEET 3 MUST BE USED FOR V90 COMPLIANCE. CONTACT & WELD TAB PLATING NOT AVAILABLE AS STANDARD.
- MINIMUM PUSHOUT FORCE: 0.50 LBS.
- PARTS TO BE PACKAGED IN TAPE AND REEL.
- ORDERS WILL BE PACKAGED ACCORDING TO THE SAMTEC PACKAGING EFFICIENCY STANDARDS (SPES) FOUND ON WWW.SAMTEC.COM.

c:\enterprisevault\DWG\MISC\MKTG\ASP-232975-01-MKT.SLDDRW

PROPRIETARY NOTE

THIS DOCUMENT CONTAINS CONFIDENTIAL AND PROPRIETARY INFORMATION AND ALL DESIGN, MANUFACTURING, REPRODUCTION, USE, PATENT RIGHTS AND SALES RIGHTS ARE EXPRESSLY RESERVED BY SAMTEC, INC. THIS DOCUMENT SHALL NOT BE DISCLOSED, IN WHOLE OR PART, TO ANY UNAUTHORIZED PERSON OR ENTITY NOR REPRODUCED, TRANSFERRED OR INCORPORATED IN ANY OTHER PROJECT IN ANY MANNER WITHOUT THE EXPRESS WRITTEN CONSENT OF SAMTEC, INC.



520 PARK EAST BLVD., NEW ALBANY, IN 47150  
PHONE: 812-944-6733 FAX: 812-948-5047  
e-Mail info@SAMTEC.com code 55322

DO NOT SCALE DRAWING SHEET SCALE: 3:2  
MATERIAL:  
INSULATOR: PCB, COLOR:BLACK  
CONTACT: COPPER ALLOY  
PLATING:  
CONTACT AREA: .000030 GOLD  
REMAINDER: .000003 GOLD  
LEADED SOLDER

DESCRIPTION:  
VITA 90 SEAF-RA 400 PIN (LEADED SOLDER)  
DWG. NO.  
ASP-232975-01  
BY: J. BROWNING 08/14/2023 SHEET 1 OF 4

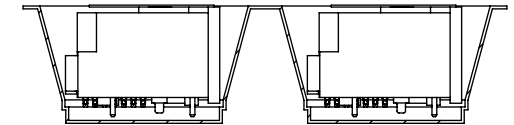
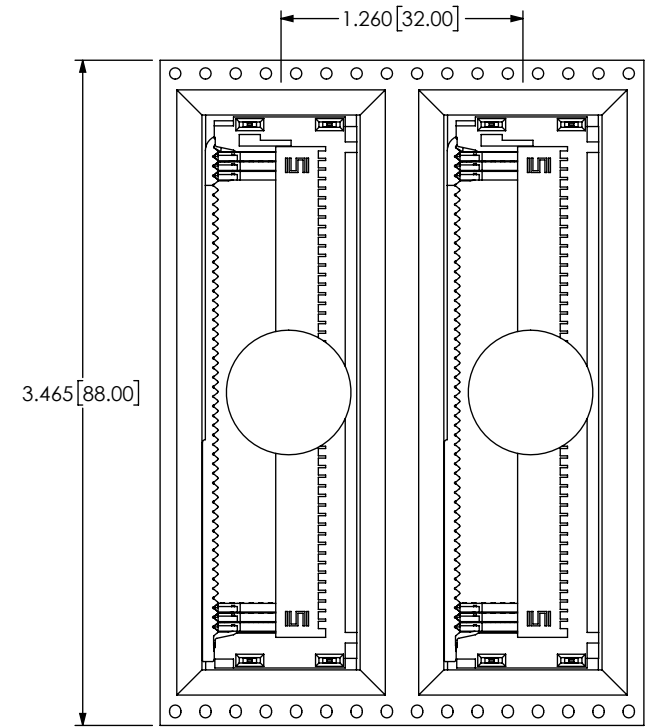
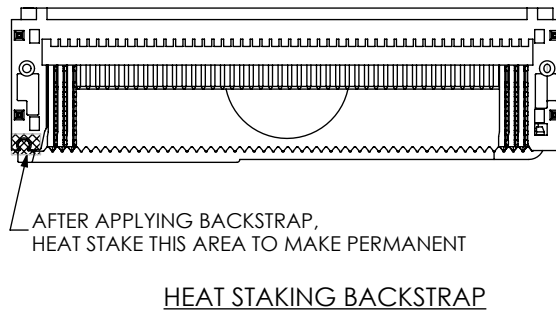
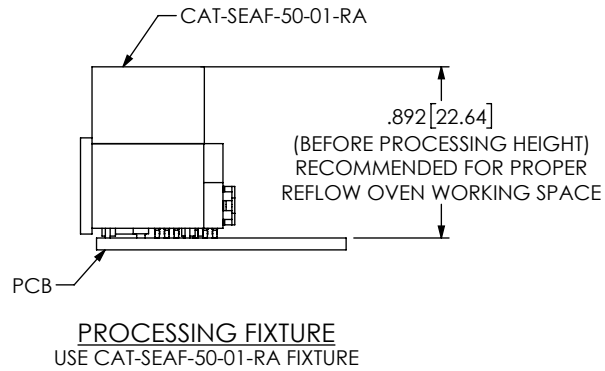

**PROPRIETARY NOTE**

THIS DOCUMENT CONTAINS CONFIDENTIAL AND PROPRIETARY INFORMATION AND ALL DESIGN, MANUFACTURING, REPRODUCTION, USE, PATENT RIGHTS AND SALES RIGHTS ARE EXPRESSLY RESERVED BY SAMTEC, INC. THIS DOCUMENT SHALL NOT BE DISCLOSED, IN WHOLE OR PART, TO ANY UNAUTHORIZED PERSON OR ENTITY NOR REPRODUCED, TRANSFERRED OR INCORPORATED IN ANY OTHER PROJECT IN ANY MANNER WITHOUT THE EXPRESS WRITTEN CONSENT OF SAMTEC, INC.



520 PARK EAST BLVD., NEW ALBANY, IN 47150  
 PHONE: 812-944-6733 FAX: 812-948-5047  
 e-Mail info@SAMTEC.com code 55322

SHEET SCALE: 1:2

DESCRIPTION:  
 VITA 90 SEAF-RA 400 PIN (LEADED SOLDER)

DWG. NO.  
 ASP-232975-01

BY: J. BROWNING 08/14/2023 SHEET 2 OF 4

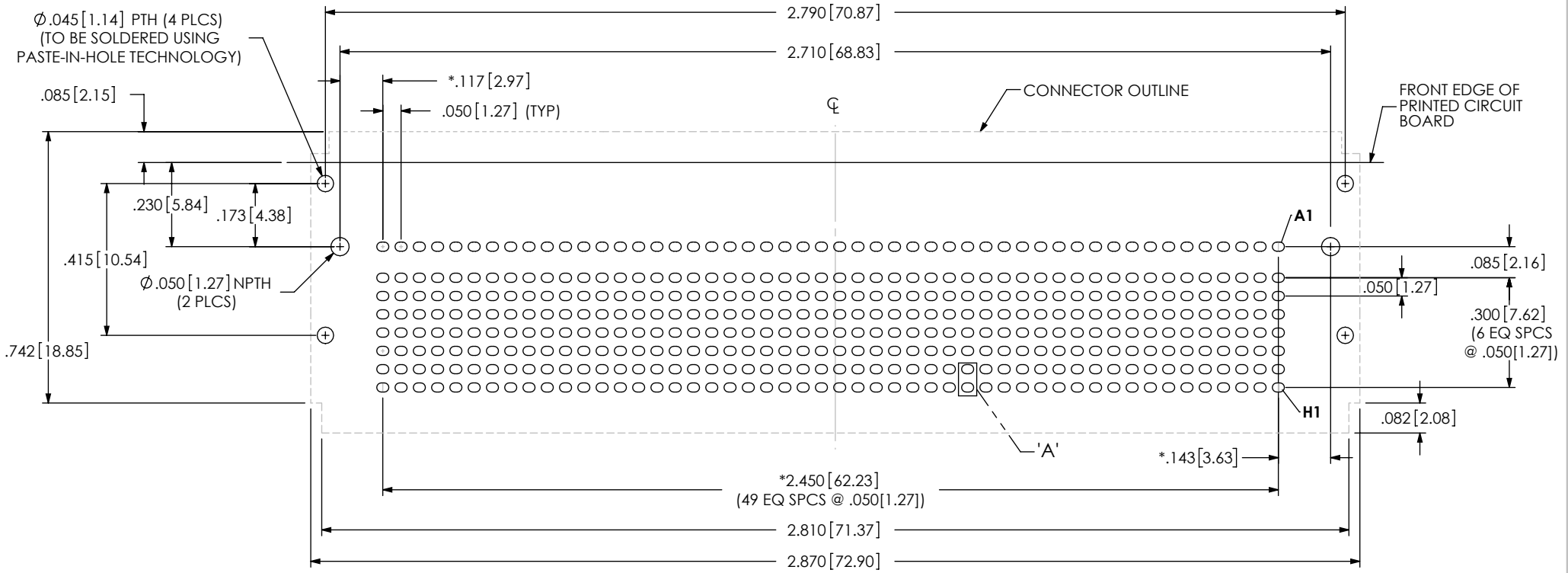

RECOMMENDED PCB LAYOUT  
 ALL DIMENSIONS ARE SYMMETRIC ABOUT THE CENTERLINE EXCEPT "\*" DIMENSIONS)

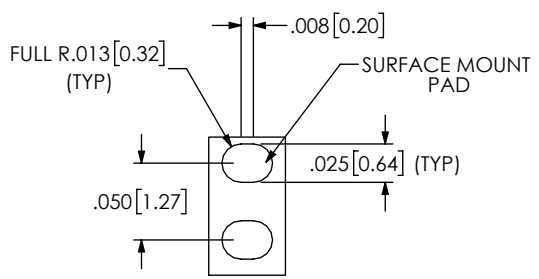

DETAIL 'A'  
 SCALE 8 : 1

<p><b>PROPRIETARY NOTE</b></p> <p>THIS DOCUMENT CONTAINS CONFIDENTIAL AND PROPRIETARY INFORMATION AND ALL DESIGN, MANUFACTURING, REPRODUCTION, USE, PATENT RIGHTS AND SALES RIGHTS ARE EXPRESSLY RESERVED BY SAMTEC, INC. THIS DOCUMENT SHALL NOT BE DISCLOSED, IN WHOLE OR PART, TO ANY UNAUTHORIZED PERSON OR ENTITY NOR REPRODUCED, TRANSFERRED OR INCORPORATED IN ANY OTHER PROJECT IN ANY MANNER WITHOUT THE EXPRESS WRITTEN CONSENT OF SAMTEC, INC.</p>	<p>520 PARK EAST BLVD., NEW ALBANY, IN 47150                  PHONE: 812-944-6733 FAX: 812-948-5047                  e-Mail info@SAMTEC.com code 55322</p>
	<p>DESCRIPTION:                  VITA 90 SEAF-RA 400 PIN (LEADED SOLDER)</p>
	<p>DWG. NO.                  ASP-232975-01</p>
<p>SHEET SCALE: 2.5:1</p>	<p>BY: J. BROWNING 08/14/2023 SHEET 3 OF 4</p>

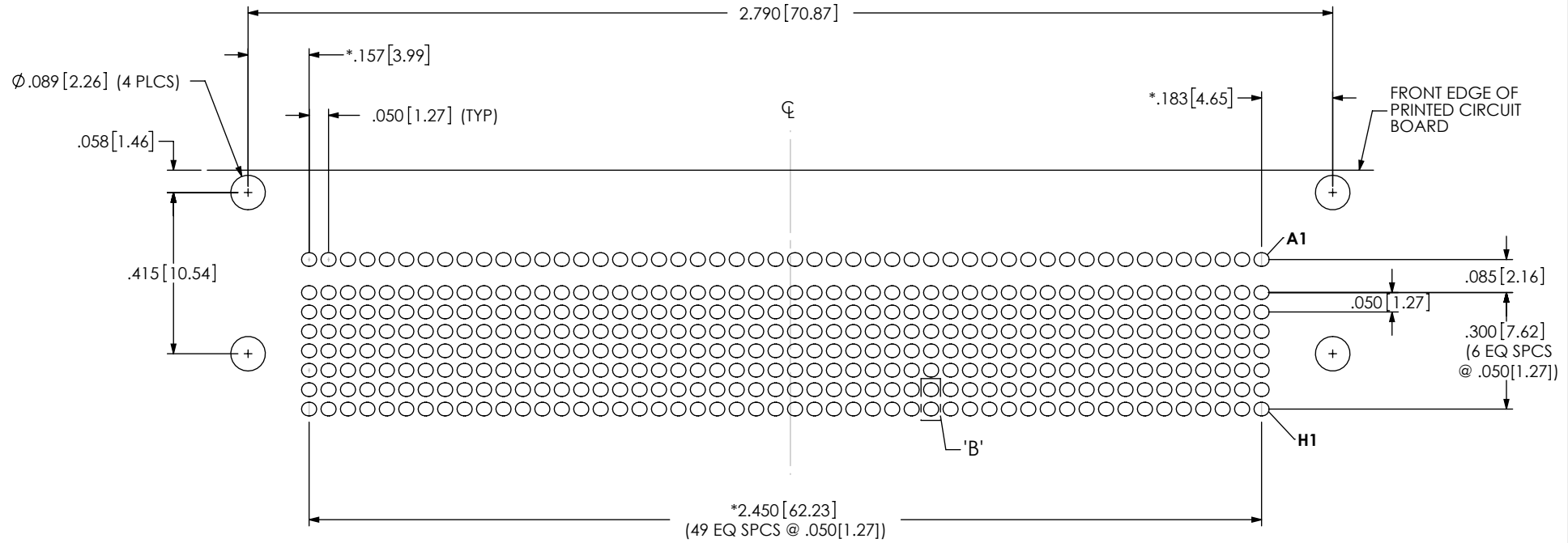

RECOMMENDED STENCIL LAYOUT  
 ALL DIMENSIONS ARE SYMMETRIC ABOUT THE CENTERLINE EXCEPT "\*" DIMENSIONS  
 STENCIL TO BE .0060 THICK

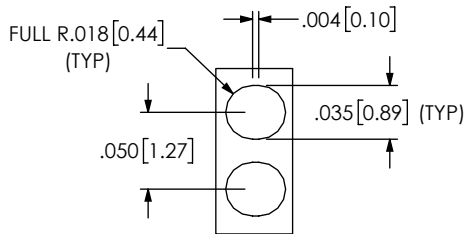

DETAIL 'B'  
 SCALE 8 : 1

<p><b>PROPRIETARY NOTE</b></p> <p>THIS DOCUMENT CONTAINS CONFIDENTIAL AND PROPRIETARY INFORMATION AND ALL DESIGN, MANUFACTURING, REPRODUCTION, USE, PATENT RIGHTS AND SALES RIGHTS ARE EXPRESSLY RESERVED BY SAMTEC, INC. THIS DOCUMENT SHALL NOT BE DISCLOSED, IN WHOLE OR PART, TO ANY UNAUTHORIZED PERSON OR ENTITY NOR REPRODUCED, TRANSFERRED OR INCORPORATED IN ANY OTHER PROJECT IN ANY MANNER WITHOUT THE EXPRESS WRITTEN CONSENT OF SAMTEC, INC.</p>	<p>520 PARK EAST BLVD, NEW ALBANY, IN 47150                  PHONE: 812-944-6733 FAX: 812-948-5047                  e-Mail info@SAMTEC.com code 55322</p>
	<p>DESCRIPTION:                  VITA 90 SEAF-RA 400 PIN (LEADED SOLDER)</p>
	<p>DWG. NO.                  ASP-232975-01</p>
<p>SHEET SCALE: 2.5:1</p>	<p>BY: J. BROWNING 08/14/2023 SHEET 4 OF 4</p>