

Pb THIS PRODUCT MANUFACTURED WITH LEAD-FREE PROCESSING

DO NOT SCALE FROM THIS PRINT

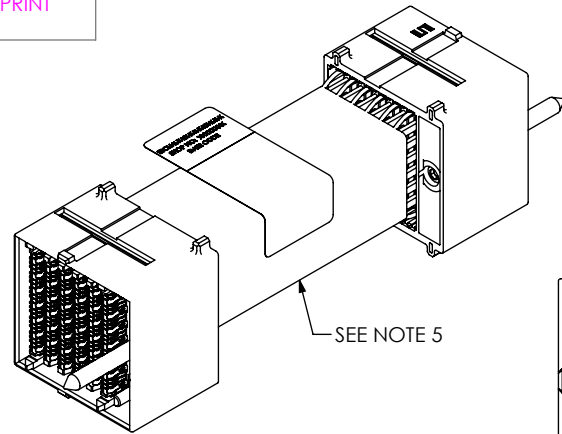

SEE NOTE 5

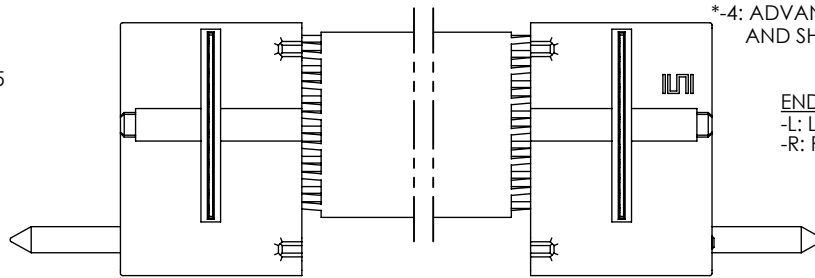

24.00[.945]

14.60[.575]

OVERALL LENGTH: [XX] + 21.18[.834]

CABLE LENGTH: [XX]±1%

32.00[1.260]

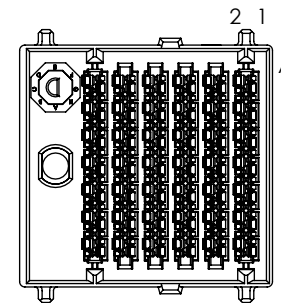
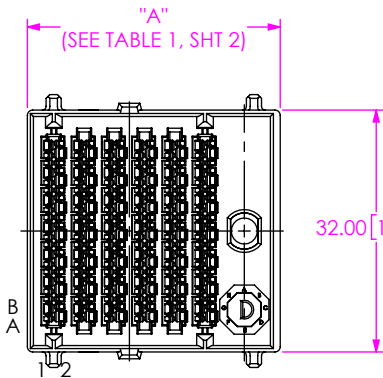

END 1

END 2

SEE NOTE 4

CABLE STYLE AND SIGNAL MAP

- 1: 34 AWG TwinAx 100OHM TX TO RX SIGNAL MAP
- 2: 30 AWG TwinAx 100OHM TX TO RX SIGNAL MAP
- 3: 34 AWG TwinAx 100OHM 1:1 SIGNAL MAP
- 4: 30 AWG TwinAx 100OHM 1:1 SIGNAL MAP
- *-5: 34 AWG TwinAx 92.5OHM TX TO RX SIGNAL MAP
- *-6: 34 AWG ThinAx 92.5OHM TX TO RX SIGNAL MAP
- *-7: 34 AWG TwinAx 92.5OHM 1:1 SIGNAL MAP
- *-8: 34 AWG ThinAx 92.5OHM 1:1 SIGNAL MAP

PAIRS PER COLUMN

- 6: 6 PAIRS

COLUMNS

- 04, -06, -08,
- 10, -12, -14, -16

END 1 PIN CONFIGURATION

- 1: STANDARD
- *-2: ADVANCED MATE
- *-3: SHORT DETECT
- *-4: ADVANCED MATE AND SHORT DETECT

END 1 GUIDE

- L: LEFT GUIDANCE
- R: RIGHT GUIDANCE

EBCM-X-6-XX-X-X-X-XX-X-XX-X

END 2 KEY

- A THRU H: DENOTES POSITION OF FLAT ON KEY
- N: NO KEY (LEAVE BLANK FOR -FV)

END 2 GUIDE

- L: LEFT GUIDANCE
- R: RIGHT GUIDANCE
- FL: FEMALE LEFT GUIDE
- FR: FEMALE RIGHT GUIDE
- FV: FEMALE VERTICAL (FL,FR,FV ONLY AVAILABLE W/ -3,-4 SIGNAL MAP)

END 2 PIN CONFIGURATION

- 1: STANDARD
- *-2: ADVANCED MATE
- *-3: SHORT DETECT
- *-4: ADVANCED MATE AND SHORT DETECT

CABLE LENGTH

- XX (INCHES)
- (06 INCHES MINIMUM, SEE NOTE 3)

END 1 KEY

- A THRU H: DENOTES POSITION OF FLAT ON KEY
- N: NO KEY

(* = NOT TOOLED)

NOTES:

1. ALL ASSEMBLIES TO BE 100% HI-POT TESTED AT 300V.
2. ALL ASSEMBLIES TO BE 100% ELECTRICALLY TESTED FOR SHORTS AND OPENS.
3. CABLE LENGTHS LONGER THAN 40 INCHES ARE NOT SUPPORTED BY S.I. TEST DATA.
4. LSX WIRE TO BE 34 AWG CO-AX STANDARD.
5. EBCM COMES STANDARD WITH SRS CABLE SLEEVING.

FIG 1
EBCM-X-6-12-1-L-G-XX-1-L-G SHOWN

PROPRIETARY NOTE
THIS DOCUMENT CONTAINS CONFIDENTIAL AND PROPRIETARY INFORMATION AND ALL DESIGN, MANUFACTURING, REPRODUCTION, USE, PATENT RIGHTS AND SALES RIGHTS ARE EXPRESSLY RESERVED BY SAMTEC, INC. THIS DOCUMENT SHALL NOT BE DISCLOSED, IN WHOLE OR PART, TO ANY UNAUTHORIZED PERSON OR ENTITY NOR REPRODUCED, TRANSFERRED OR INCORPORATED IN ANY OTHER PROJECT IN ANY MANNER WITHOUT THE EXPRESS WRITTEN CONSENT OF SAMTEC, INC.



520 PARK EAST BLVD, NEW ALBANY, IN 47150
PHONE: 812-944-6733 FAX: 812-948-5047
e-Mail info@SAMTEC.com code 55322

DO NOT SCALE DRAWING
SHEET SCALE: 1:1
MATERIAL:
INSULATOR: LCP
SIGNAL & GROUND PINS: COPPER ALLOY
PLATING: 30µ" SELECTIVE GOLD IN CONTACT AREA

DESCRIPTION:
EXAMAX BACKPLANE CABLE
DWG. NO.
EBCM-X-6-XX-X-X-X-XX-X-XX-X

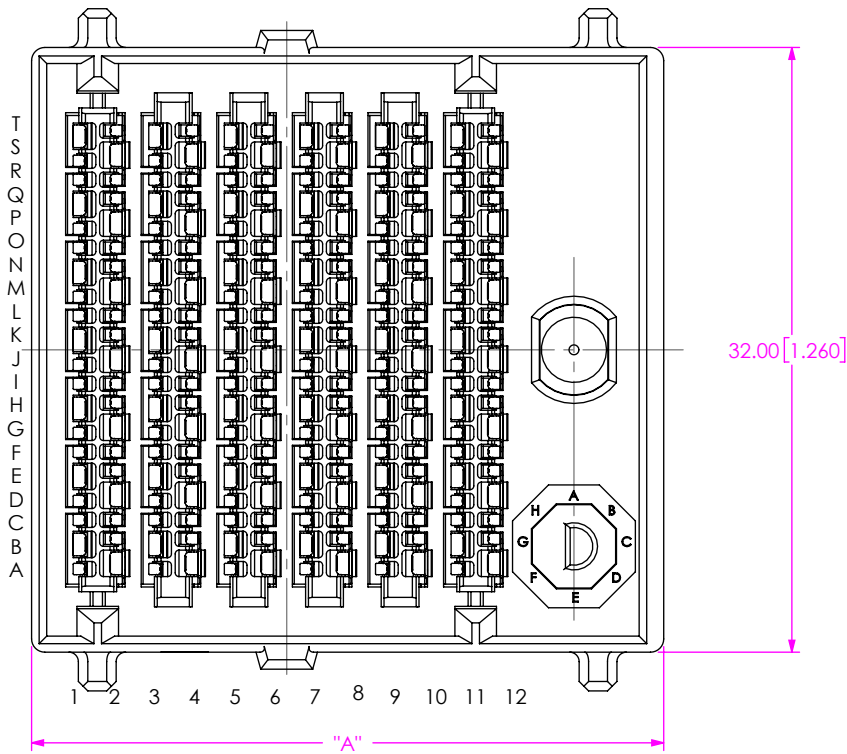

FIG 2
EBCM-X-6-12-1-L-G END 1 DETAILS SHOWN

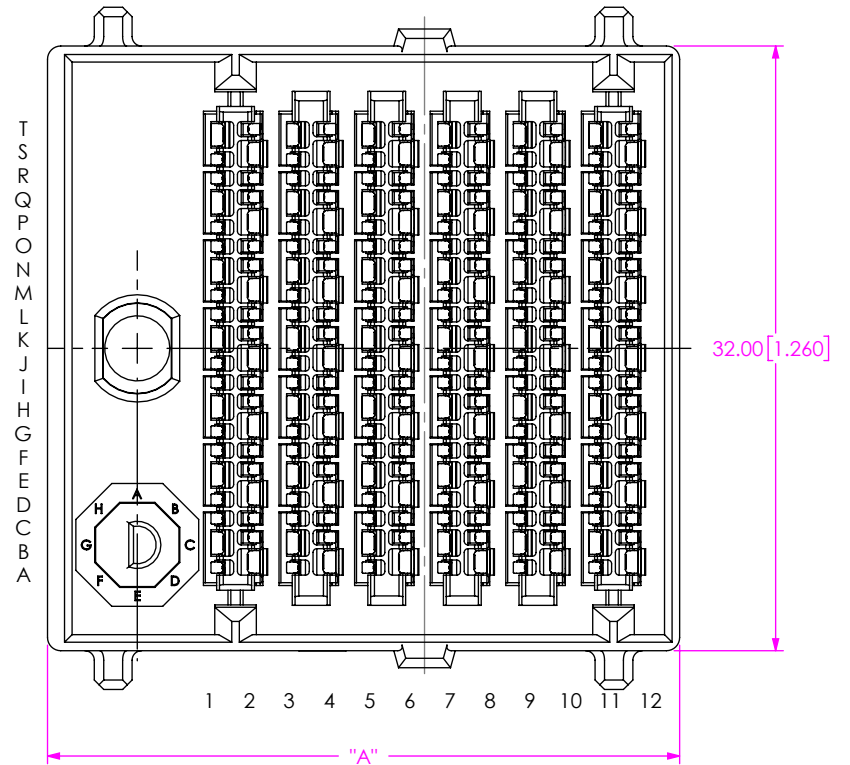

FIG 3
EBCM-X-6-12-1-R-G END 1 DETAILS SHOWN

COLUMNS	"A"
-04	17.450 [1.6870]
-06	21.450 [1.8445]
-08	25.450 [1.0020]
-10	29.450 [1.1594]
-12	33.450 [1.3169]
-14	37.450 [1.4744]
-16	41.450 [1.6319]

F:\DWG\MISC\Mktg\EBCM-X-6-XX-X-X-XX-X-MKT.slddrw

PROPRIETARY NOTE
 THIS DOCUMENT CONTAINS CONFIDENTIAL AND PROPRIETARY INFORMATION AND ALL DESIGN, MANUFACTURING, REPRODUCTION, USE, PATENT RIGHTS AND SALES RIGHTS ARE EXPRESSLY RESERVED BY SAMTEC, INC. THIS DOCUMENT SHALL NOT BE DISCLOSED, IN WHOLE OR PART, TO ANY UNAUTHORIZED PERSON OR ENTITY NOR REPRODUCED, TRANSFERRED OR INCORPORATED IN ANY OTHER PROJECT IN ANY MANNER WITHOUT THE EXPRESS WRITTEN CONSENT OF SAMTEC, INC.

samtec
 520 PARK EAST BLVD, NEW ALBANY, IN 47150
 PHONE: 812-944-6733 FAX: 812-948-5047
 e-Mail info@SAMTEC.com code 55322

DO NOT SCALE DRAWING

SHEET SCALE: 2.5:1

DESCRIPTION:
EXAMAX BACKPLANE CABLE

DWG. NO.
EBCM-X-6-XX-X-X-X-XX-X-XX-X

BY: D.SCHMELZ 4/10/2017 SHEET 2 OF 7

END 1 ORIENTATIONS

END 2 ORIENTATIONS

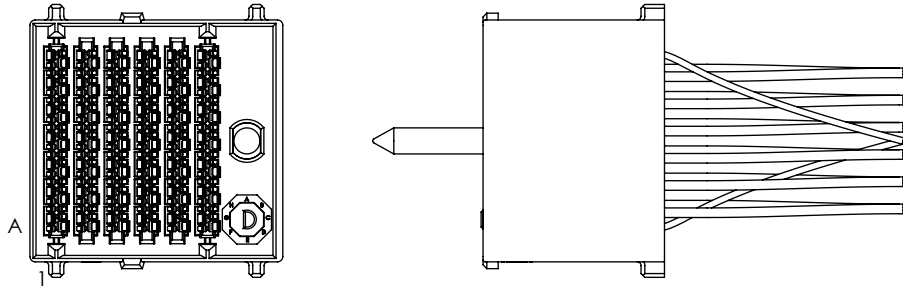

EBCM-X-6-12-X-L-G-XX-X-X-X SHOWN

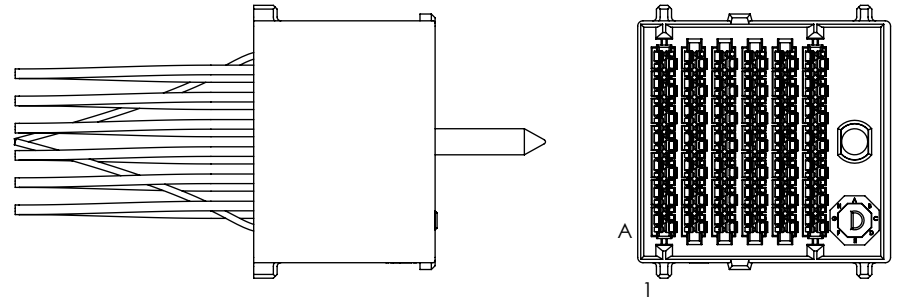

EBCM-X-6-12-X-X-X-XX-X-L-G SHOWN

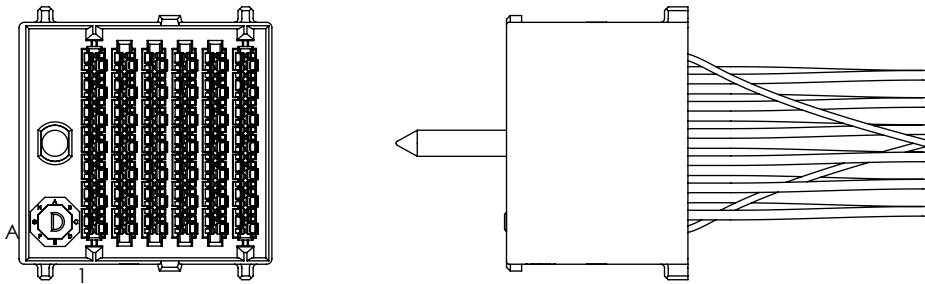

EBCM-X-6-12-X-R-G-XX-X-X-X SHOWN

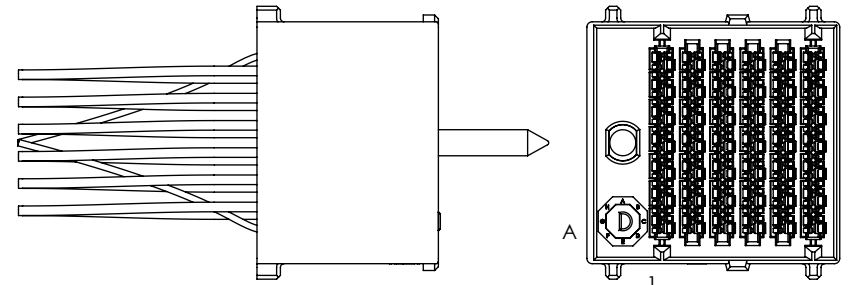

EBCM-X-6-12-X-X-X-XX-X-R-G SHOWN

PROPRIETARY NOTE
 THIS DOCUMENT CONTAINS CONFIDENTIAL AND PROPRIETARY INFORMATION AND ALL DESIGN, MANUFACTURING, REPRODUCTION, USE, PATENT RIGHTS AND SALES RIGHTS ARE EXPRESSLY RESERVED BY SAMTEC, INC. THIS DOCUMENT SHALL NOT BE DISCLOSED, IN WHOLE OR PART, TO ANY UNAUTHORIZED PERSON OR ENTITY NOR REPRODUCED, TRANSFERRED OR INCORPORATED IN ANY OTHER PROJECT IN ANY MANNER WITHOUT THE EXPRESS WRITTEN CONSENT OF SAMTEC, INC.



520 PARK EAST BLVD, NEW ALBANY, IN 47150
 PHONE: 812-944-6733 FAX: 812-948-5047
 e-Mail info@SAMTEC.com code 55322

DO NOT SCALE DRAWING

SHEET SCALE: 1:1

DESCRIPTION:
 EXAMAX BACKPLANE CABLE

DWG. NO.
EBCM-X-6-XX-X-X-X-XX-X-XX-X

BY: D.SCHMELZ 4/10/2017 SHEET 3 OF 7

END 2 ORIENTATIONS

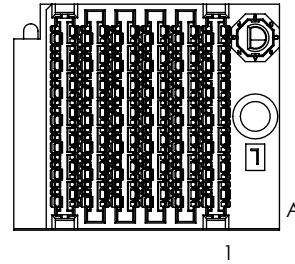
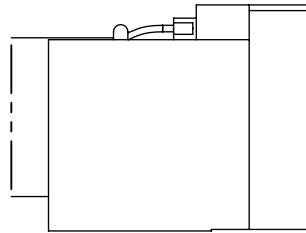

EBCM-X-6-12-X-X-X-XX-X-FL-G SHOWN

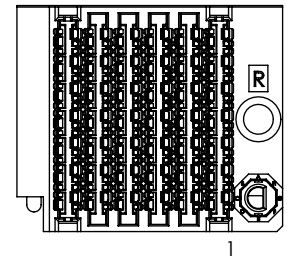
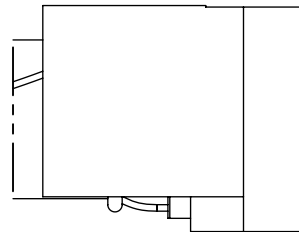

EBCM-X-6-12-X-X-X-XX-X-FR-G SHOWN

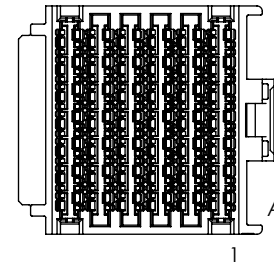
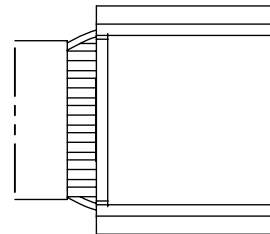

EBCM-X-6-12-X-X-X-XX-X-FV-G SHOWN

PROPRIETARY NOTE
 THIS DOCUMENT CONTAINS CONFIDENTIAL AND PROPRIETARY INFORMATION AND ALL DESIGN, MANUFACTURING, REPRODUCTION, USE, PATENT RIGHTS AND SALES RIGHTS ARE EXPRESSLY RESERVED BY SAMTEC, INC. THIS DOCUMENT SHALL NOT BE DISCLOSED, IN WHOLE OR PART, TO ANY UNAUTHORIZED PERSON OR ENTITY NOR REPRODUCED, TRANSFERRED OR INCORPORATED IN ANY OTHER PROJECT IN ANY MANNER WITHOUT THE EXPRESS WRITTEN CONSENT OF SAMTEC, INC.



520 PARK EAST BLVD, NEW ALBANY, IN 47150
 PHONE: 812-944-6733 FAX: 812-948-5047
 e-Mail info@SAMTEC.com code 55322

DO NOT SCALE DRAWING

SHEET SCALE: 1:1

DESCRIPTION:
 EXAMAX BACKPLANE CABLE

DWG. NO.
EBCM-X-6-XX-X-X-X-XX-X-XX-X

BY: D.SCHMELZ 4/10/2017 SHEET 4 OF 7

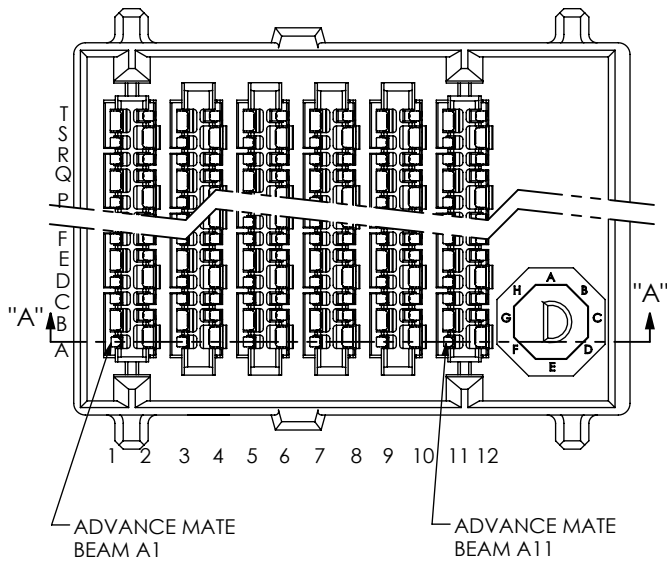
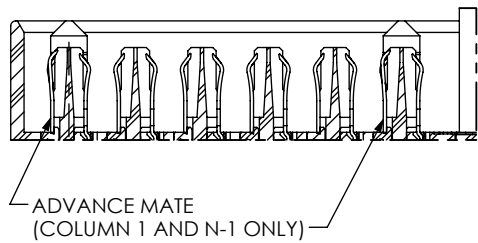

FIG 4
EBCM-X-6-12-2-L-G SHOWN
(DIFFERENT AS AHWN, OTHERWISE SAME AS FIG 1)
(NOT TOOLED)



SECTION "A"-"A"
SCALE 2.2 : 1

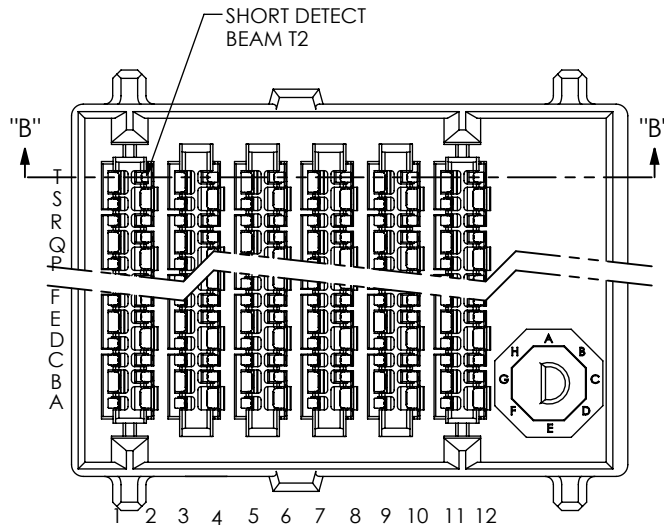
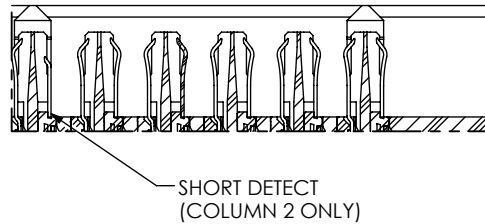

FIG 5
EBCM-X-6-12-3-L-G SHOWN
(DIFFERENT AS AHWN, OTHERWISE SAME AS FIG 1)
(NOT TOOLED)



SECTION "B"-"B"
SCALE 2.2 : 1

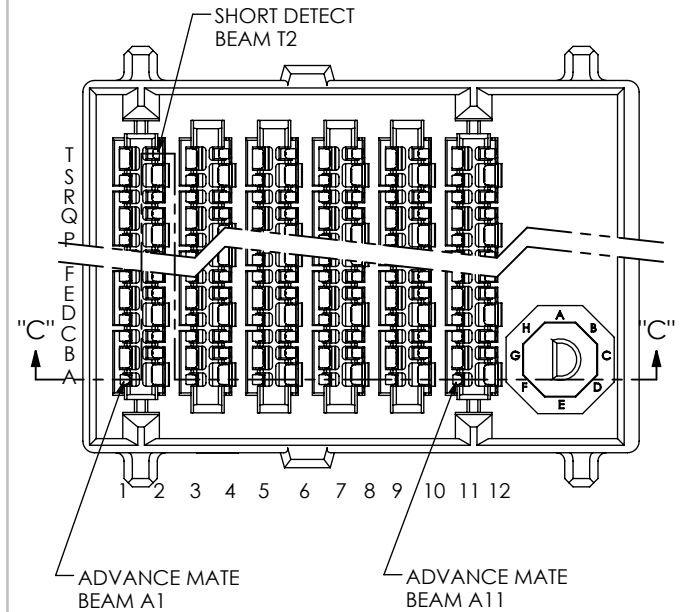
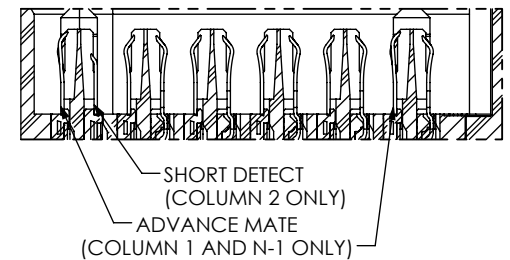

FIG 6
EBCM-X-6-12-4-L-G SHOWN
(DIFFERENT AS AHWN, OTHERWISE SAME AS FIG 1)
(NOT TOOLED)



SECTION "C"-"C"
SCALE 2.2 : 1

PROPRIETARY NOTE
THIS DOCUMENT CONTAINS CONFIDENTIAL AND PROPRIETARY INFORMATION AND ALL DESIGN, MANUFACTURING, REPRODUCTION, USE, PATENT RIGHTS AND SALES RIGHTS ARE EXPRESSLY RESERVED BY SAMTEC, INC. THIS DOCUMENT SHALL NOT BE DISCLOSED, IN WHOLE OR PART, TO ANY UNAUTHORIZED PERSON OR ENTITY NOR REPRODUCED, TRANSFERRED OR INCORPORATED IN ANY OTHER PROJECT IN ANY MANNER WITHOUT THE EXPRESS WRITTEN CONSENT OF SAMTEC, INC.



520 PARK EAST BLVD, NEW ALBANY, IN 47150
PHONE: 812-944-6733 FAX: 812-948-5047
e-Mail info@SAMTEC.com code 55322

DO NOT SCALE DRAWING

SHEET SCALE: 2.8:1

DESCRIPTION:
EXAMAX BACKPLANE CABLE

DWG. NO.
EBCM-X-6-XX-X-X-X-XX-X-XX-X

BY: D.SHMELZ 4/10/2017 SHEET 5 OF 7

ROW	TABLE 2, 6 PAIR PIN-OUT															
T	GND	LS2	GND	LS4	GND	LS6	GND	LS8	GND	LS10	GND	LS12	GND	LS14	GND	LS16
S	TX1+	GND	TX7+	GND	TX13+	GND	TX19+	GND	TX25+	GND	TX31+	GND	TX37+	GND	TX43+	GND
R	TX1-	TX4+	TX7-	TX10+	TX13-	TX16+	TX19-	TX22+	TX25-	TX28+	TX31-	TX34+	TX37-	TX40+	TX43+	TX46+
Q	GND	TX4-	GND	TX10-	GND	TX16-	GND	TX22-	GND	TX28-	GND	TX34-	GND	TX40-	GND	TX46-
P	TX2+	GND	TX8+	GND	TX14+	GND	TX20+	GND	TX26+	GND	TX32+	GND	TX38+	GND	TX44+	GND
O	TX2-	TX5+	TX8-	TX11+	TX14-	TX17+	TX20-	TX23+	TX26-	TX29+	TX32-	TX35+	TX38-	TX41+	TX44-	TX47+
N	GND	TX5-	GND	TX11-	GND	TX17-	GND	TX23-	GND	TX29-	GND	TX35-	GND	TX41-	GND	TX47-
M	TX3+	GND	TX9+	GND	TX15+	GND	TX21+	GND	TX27+	GND	TX33+	GND	TX39+	GND	TX45+	GND
L	TX3-	TX6+	TX9-	TX12+	TX15-	TX18+	TX21-	TX24+	TX27-	TX30+	TX33-	TX36+	TX39-	TX42+	TX45-	TX48+
K	GND	TX6-	GND	TX12-	GND	TX18-	GND	TX24-	GND	TX30-	GND	TX36-	GND	TX42-	GND	TX48-
J	RX3-	GND	RX9-	GND	RX15-	GND	RX21-	GND	RX27-	GND	RX33-	GND	RX39-	GND	RX45-	GND
I	RX3+	RX6-	RX9+	RX12-	RX15+	RX18-	RX21+	RX24-	RX27+	RX30-	RX33+	RX36-	RX39+	RX42-	RX45+	RX48-
H	GND	RX6+	GND	RX12+	GND	RX18+	GND	RX24+	GND	RX30+	GND	RX36+	GND	RX42+	GND	RX48+
G	RX2-	GND	RX8-	GND	RX14-	GND	RX20-	GND	RX26-	GND	RX32-	GND	RX38-	GND	RX44-	GND
F	RX2+	RX5-	RX8+	RX11-	RX14+	RX17-	RX20+	RX23-	RX26+	RX29-	RX32+	RX35-	RX38+	RX41-	RX44+	RX47-
E	GND	RX5+	GND	RX11+	GND	RX17+	GND	RX23+	GND	RX29+	GND	RX35+	GND	RX41+	GND	RX47+
D	RX1-	GND	RX7-	GND	RX13-	GND	RX19-	GND	RX25-	GND	RX31-	GND	RX37-	GND	RX43-	GND
C	RX1+	RX4-	RX7+	RX10-	RX13+	RX16-	RX19+	RX22-	RX25+	RX28-	RX31+	RX34-	RX37+	RX40-	RX43+	RX46-
B	GND	RX4+	GND	RX10+	GND	RX16+	GND	RX22+	GND	RX28+	GND	RX34+	GND	RX40+	GND	RX46+
A	LS1	GND	LS3	GND	LS5	GND	LS7	GND	LS9	GND	LS11	GND	LS13	GND	LS15	GND
	1	2	3	4	5	6	7	8	9	10	11	12	13	14	15	16
WAFER	A	B	A	B	A	B	A	B	A	B	A	B	A	B	A	B

• PROPRIETARY NOTE •
 THIS DOCUMENT CONTAINS CONFIDENTIAL AND PROPRIETARY INFORMATION AND ALL DESIGN, MANUFACTURING, REPRODUCTION, USE, PATENT RIGHTS AND SALES RIGHTS ARE EXPRESSLY RESERVED BY SAMTEC, INC. THIS DOCUMENT SHALL NOT BE DISCLOSED, IN WHOLE OR PART, TO ANY UNAUTHORIZED PERSON OR ENTITY NOR REPRODUCED, TRANSFERRED OR INCORPORATED IN ANY OTHER PROJECT IN ANY MANNER WITHOUT THE EXPRESS WRITTEN CONSENT OF SAMTEC, INC.



520 PARK EAST BLVD, NEW ALBANY, IN 47150
 PHONE: 812-944-6733 FAX: 812-948-5047
 e-Mail info@SAMTEC.com code 55322

DO NOT SCALE DRAWING

SHEET SCALE: 3:1

DESCRIPTION:
 EXAMAX BACKPLANE CABLE

DWG. NO.
EBCM-X-6-XX-X-X-X-XX-X-XX-X

BY: D.SCHMELZ 4/10/2017 SHEET 6 OF 7

6 PAIR SIGNAL MAPPING FOR -1 AND -2 SIGNAL MAP OPTIONS									
ODD NUMBER COLUMNS					EVEN NUMBER COLUMNS				
END 1		PAIR	END 2		END 1		PAIR	END 2	
POSITION	SYMBOL		POSITION	SYMBOL	POSITION	SYMBOL		POSITION	SYMBOL
T1	GND		B1	GND	T2	LS2		T2	LS2
S1	TX1+	PAIR	C1	RX1+	S2	GND		A2	GND
R1	TX1-		D1	RX1-	R2	TX4+	PAIR	B2	RX4+
Q1	GND		E1	GND	Q2	TX4-			C2
P1	TX2+	PAIR	F1	RX2+	P2	GND		D2	GND
O1	TX2-		G1	RX2-	O2	TX5+	PAIR	E2	RX5+
N1	GND		H1	GND	N2	TX5-			F2
M1	TX3+	PAIR	I1	RX3+	M2	GND		G2	GND
L1	TX3-		J1	RX3-	L2	TX6+	PAIR	H2	RX6+
K1	GND		K1	GND	K2	TX6-			I2
J1	RX3-	PAIR	L1	TX3-	J2	GND		J2	GND
I1	RX3+		M1	TX3+	I2	RX6-	PAIR	K2	TX6-
H1	GND		N1	GND	H2	RX6+			L2
G1	RX2-	PAIR	O1	TX2-	G2	GND		M2	GND
F1	RX2+		P1	TX2+	F2	RX5-	PAIR	N2	TX5-
E1	GND		Q1	GND	E2	RX5+			O2
D1	RX1-	PAIR	R1	TX1-	D2	GND		P2	GND
C1	RX1+		S1	TX1+	C2	RX4-	PAIR	Q2	TX4-
B1	GND		T1	GND	B2	RX4+			R2
A1	LS1		A1	LS1	A2	GND		S2	GND

ALL GROUNDS ARE COMMON AND TIED TO CABLE SHIELD

6 PAIR SIGNAL MAPPING FOR -3 AND -4 SIGNAL MAP OPTIONS									
ODD NUMBER COLUMNS					EVEN NUMBER COLUMNS				
END 1		PAIR	END 2		END 1		PAIR	END 2	
POSITION	SYMBOL		POSITION	SYMBOL	POSITION	SYMBOL		POSITION	SYMBOL
T1	GND		T1	GND	T2	LS2		T2	LS2
S1	TX1+	PAIR	S1	TX1+	S2	GND		S2	GND
R1	TX1-		R1	TX1-	R2	TX4+	PAIR	R2	TX4+
Q1	GND		Q1	GND	Q2	TX4-			Q2
P1	TX2+	PAIR	P1	TX2+	P2	GND		P2	GND
O1	TX2-		O1	TX2-	O2	TX5+	PAIR	O2	TX5+
N1	GND		N1	GND	N2	TX5-			N2
M1	TX3+	PAIR	M1	TX3+	M2	GND		M2	GND
L1	TX3-		L1	TX3-	L2	TX6+	PAIR	L2	TX6+
K1	GND		K1	GND	K2	TX6-			K2
J1	RX3-	PAIR	J1	RX3-	J2	GND		J2	GND
I1	RX3+		I1	RX3+	I2	RX6-	PAIR	I2	RX6-
H1	GND		H1	GND	H2	RX6+			H2
G1	RX2-	PAIR	G1	RX2-	G2	GND		G2	GND
F1	RX2+		F1	RX2+	F2	RX5-	PAIR	F2	RX5-
E1	GND		E1	GND	E2	RX5+			E2
D1	RX1-	PAIR	D1	RX1-	D2	GND		D2	GND
C1	RX1+		C1	RX1+	C2	RX4-	PAIR	C2	RX4-
B1	GND		B1	GND	B2	RX4+			B2
A1	LS1		A1	LS1	A2	GND		A2	GND

ALL GROUNDS ARE COMMON AND TIED TO CABLE SHIELD

F:\DWG\MISC\Mktg\EBCM-X-6-XX-X-X-XX-X-XX-X-MKT.sldrwh

PROPRIETARY NOTE
 THIS DOCUMENT CONTAINS CONFIDENTIAL AND PROPRIETARY INFORMATION AND ALL DESIGN, MANUFACTURING, REPRODUCTION, USE, PATENT RIGHTS AND SALES RIGHTS ARE EXPRESSLY RESERVED BY SAMTEC, INC. THIS DOCUMENT SHALL NOT BE DISCLOSED, IN WHOLE OR PART, TO ANY UNAUTHORIZED PERSON OR ENTITY NOR REPRODUCED, TRANSFERRED OR INCORPORATED IN ANY OTHER PROJECT IN ANY MANNER WITHOUT THE EXPRESS WRITTEN CONSENT OF SAMTEC, INC.



DO NOT SCALE DRAWING
 SHEET SCALE: 3:1

DESCRIPTION:
 EXAMAX BACKPLANE CABLE
 DWG. NO.
EBCM-X-6-XX-X-X-X-XX-X-XX-X
 BY: D.SCHMELZ 4/10/2017 SHEET 7 OF 7