

DO NOT  
SCALE FROM  
THIS PRINT

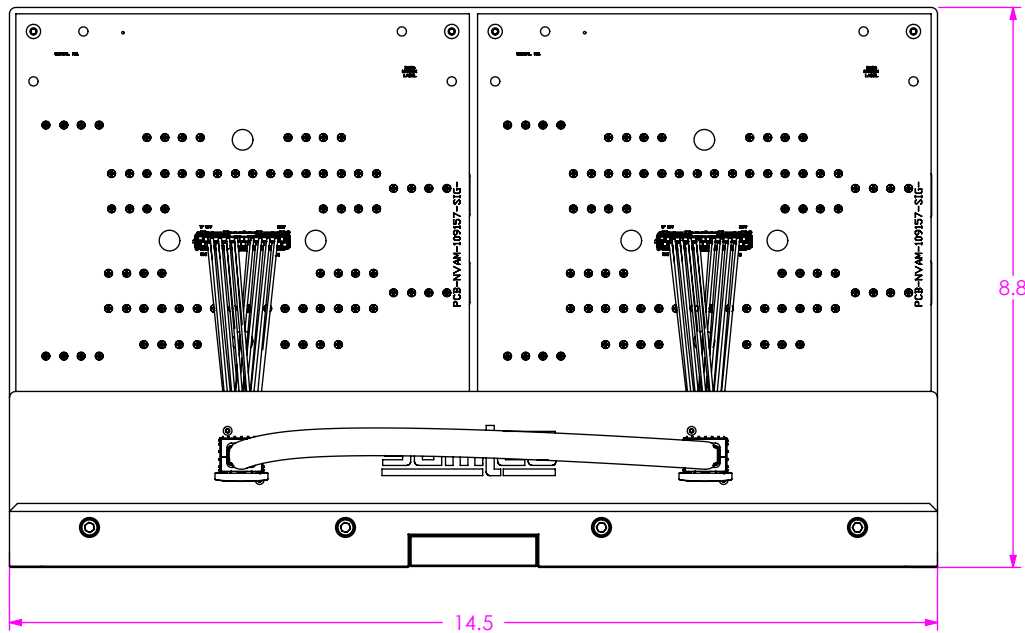

REF-224735-X.XX-XX

**SMA STYLE**

- 1.85: 1.85mm SMAS
- 2.40: 2.40mm SMAS
- 2.92: 2.92mm SMAS

**OPTIONS**

- 01: 0.5m NVACE
- 02: 1.0m NVACE
- 03: 2.0m NVACE

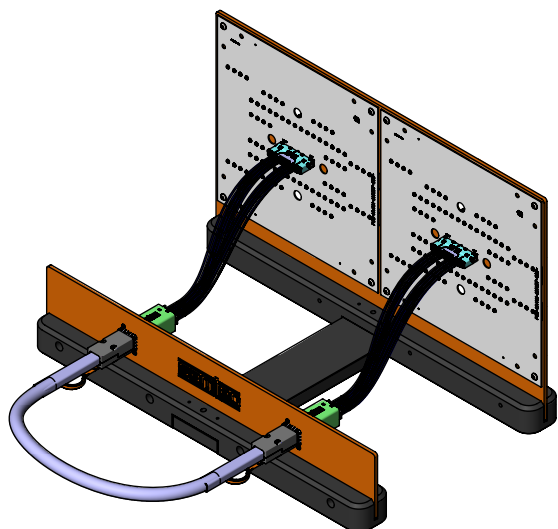
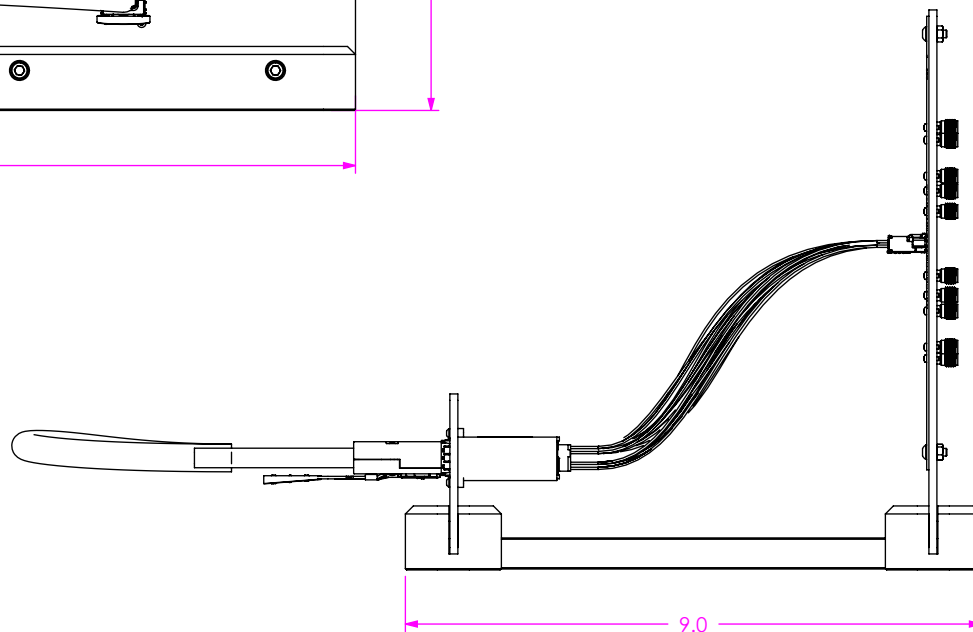

- NOTES:
1. COMPONENTS ARE PACKAGED SEPARATELY
  2. ESD BAGS NOT SHOWN FOR CLARITY
  3. REFERENCE NA-{HD-SC-}-WI-3001-M FOR PACKAGING INSTRUCTIONS

<p>TOLERANCES DO NOT APPLY TO REFERENCE DIMENSIONS. UNLESS OTHERWISE SPECIFIED, DIMENSIONS ARE IN INCHES. TOLERANCES ARE:</p> <p>DECIMALS      ANGLES</p> <p>.XX: ±.01 [.3]      2°</p> <p>.XXX: ±.005 [.13]</p> <p>.XXXX: ±.0020 [.051]</p>	<p><b>PROPRIETARY NOTE</b></p> <p>THIS DOCUMENT CONTAINS CONFIDENTIAL AND PROPRIETARY INFORMATION AND ALL DESIGN, MANUFACTURING, REPRODUCTION, USE, PATENT RIGHTS AND SALES RIGHTS ARE EXPRESSLY RESERVED BY SAMTEC, INC. THIS DOCUMENT SHALL NOT BE DISCLOSED, IN WHOLE OR PART, TO ANY UNAUTHORIZED PERSON OR ENTITY NOR REPRODUCED, TRANSFERRED OR INCORPORATED IN ANY OTHER PROJECT IN ANY MANNER WITHOUT THE EXPRESS WRITTEN CONSENT OF SAMTEC, INC.</p>	 <p>520 PARK EAST BLVD, NEW ALBANY, IN 47150 PHONE: 812-944-6733    FAX: 812-948-5047 e-Mail: info@SAMTEC.com    code 55322</p>
<p>DO NOT SCALE DRAWING      SHEET SCALE: 1:8</p> <p>MATERIAL:</p>	<p>DESCRIPTION: NOVARAY IO EVALUATION KIT</p>	
<p>F:\DWG\MISC\MKTG\REF-224735-X.XX-XX-MKT.SLDDRW</p>	<p>DWG. NO. REF-224735-X.XX-XX</p> <p>BY:CHRISTIAN S. 04/24/2023 SHEET 1 OF 3</p>	

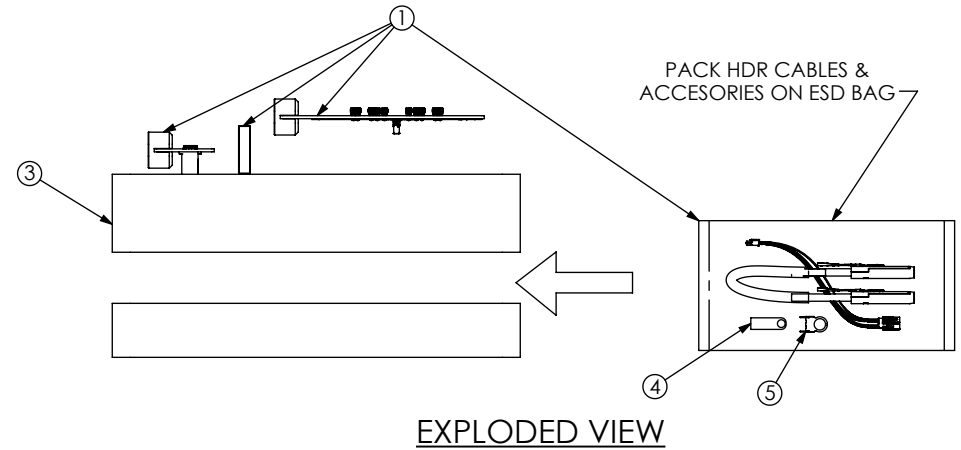
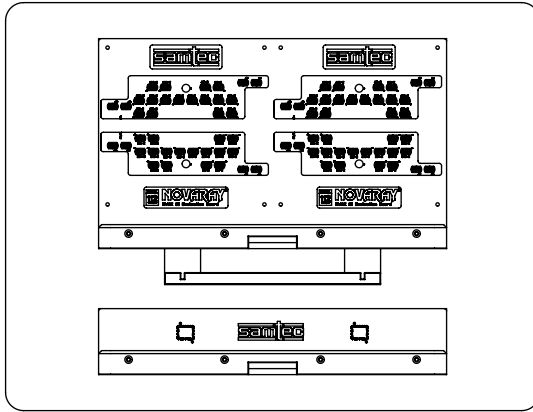

PACKAGING VIEW

<p><b>PROPRIETARY NOTE</b></p> <p>THIS DOCUMENT CONTAINS CONFIDENTIAL AND PROPRIETARY INFORMATION AND ALL DESIGN, MANUFACTURING, REPRODUCTION, USE, PATENT RIGHTS AND SALES RIGHTS ARE EXPRESSLY RESERVED BY SAMTEC, INC. THIS DOCUMENT SHALL NOT BE DISCLOSED, IN WHOLE OR PART, TO ANY UNAUTHORIZED PERSON OR ENTITY NOR REPRODUCED, TRANSFERRED OR INCORPORATED IN ANY OTHER PROJECT IN ANY MANNER WITHOUT THE EXPRESS WRITTEN CONSENT OF SAMTEC, INC.</p>	 <p>520 PARK EAST BLVD, NEW ALBANY, IN 47150          PHONE: 812-944-6733 FAX: 812-948-5047          e-Mail info@SAMTEC.com code 55322</p>
<p>SHEET SCALE: 1:8</p>	<p>DESCRIPTION: NOVARAY IO EVALUATION KIT</p>
	<p>DWG. NO. <b>REF-224735-X.XX-XX</b></p>
<p>F:\DWG\MISC\MKTG\REF-224735-X.XX-XX-MKT.SLDDRW</p>	<p>BY:CHRISTIAN S. 04/24/2023 SHEET 2 OF 3</p>

SIGNAL MAPPING

NVAM-C	REF DES	J4	J2	J5	J3	J9	J7	J8	J6	J13	J11	J12	J10	J17	J15	J16	J14	J20	J18	J21	J19	J25	J23	J24	J22	J29	J27	J28	J26	J33	J31	J32	J30
	CONNECTOR PIN	A02	A03	A06	A07	A10	A11	A14	A15	A18	A19	A22	A23	A26	A27	A30	A31	B02	B03	B06	B07	B10	B11	B14	B15	B18	B19	B22	B23	B26	B27	B30	B31
NVAM-C	CONNECTOR PIN	A02	A03	A06	A07	A10	A11	A14	A15	A18	A19	A22	A23	A26	A27	A30	A31	B02	B03	B06	B07	B10	B11	B14	B15	B18	B19	B22	B23	B26	B27	B30	B31
	REF DES	J4	J2	J5	J3	J9	J7	J8	J6	J13	J11	J12	J10	J17	J15	J16	J14	J20	J18	J21	J19	J25	J23	J24	J22	J29	J27	J28	J26	J33	J31	J32	J30

BOM TABLE

ITEM	PART NUMBER	QTY	COST QTY	DESCRIPTION
1	SEE TABLE A	1	1	EVALUATION KIT
2	CCS-206303-01	1	1	PELICAN CASE
3	F-NVAX005	1	1	FOAM
4	CCS-207056-01-MC	1	1	FLASH DRIVE
5	CAT-EX-NVACP-04	1	1	EXTRACTION TOOL

TABLE A

SMA STYLE	OPTION	PART NUMBER
1.85	01	S-REF-224735-1.85-01
	02	S-REF-224735-1.85-02
	03	S-REF-224735-1.85-03
2.40	01	S-REF-224735-2.40-01
	02	S-REF-224735-2.40-02
	03	S-REF-224735-2.40-03
2.92	01	S-REF-224735-2.92-01
	02	S-REF-224735-2.92-02
	03	S-REF-224735-2.92-03

PROPRIETARY NOTE

THIS DOCUMENT CONTAINS CONFIDENTIAL AND PROPRIETARY INFORMATION AND ALL DESIGN, MANUFACTURING, REPRODUCTION, USE, PATENT RIGHTS AND SALES RIGHTS ARE EXPRESSLY RESERVED BY SAMTEC, INC. THIS DOCUMENT SHALL NOT BE DISCLOSED, IN WHOLE OR PART, TO ANY UNAUTHORIZED PERSON OR ENTITY NOR REPRODUCED, TRANSFERRED OR INCORPORATED IN ANY OTHER PROJECT IN ANY MANNER WITHOUT THE EXPRESS WRITTEN CONSENT OF SAMTEC, INC.



520 PARK EAST BLVD, NEW ALBANY, IN 47150  
 PHONE: 812-944-6733 FAX: 812-948-5047  
 e-Mail info@SAMTEC.com code 55322

DO NOT SCALE DRAWING

DESCRIPTION:  
NOVARAY IO EVALUATION KIT

DWG. NO.  
REF-224735-X.XX-XX

SHEET SCALE: 1:4

BY: CHRISTIAN S. 04/24/2023 SHEET 3 OF 3