

DO NOT SCALE FROM THIS PRINT

DESIGNED & DIMENSIONED IN MILLIMETERS [INCHES]

SMA-J-C-X-ST-BH4

GENDER
-J: JACK

TYPE
-C: CABLE

TERMINATION
-BH4: BULKHEAD (MH113 CABLE)

ORIENTATION
-ST: STRAIGHT

PLATING SPECIFICATION
-H: HEAVY GOLD (SEE NOTES 7 & 8)
(SMA-NUT-001-F)
(SMA-LWAS-001-F)
(SUB-SMA-J-C-F-ST-BH3)
(SMA-SKT-004-H)
(SMA-INS-017)
(SMA-J-C-F-ST-BH4-CBDY)

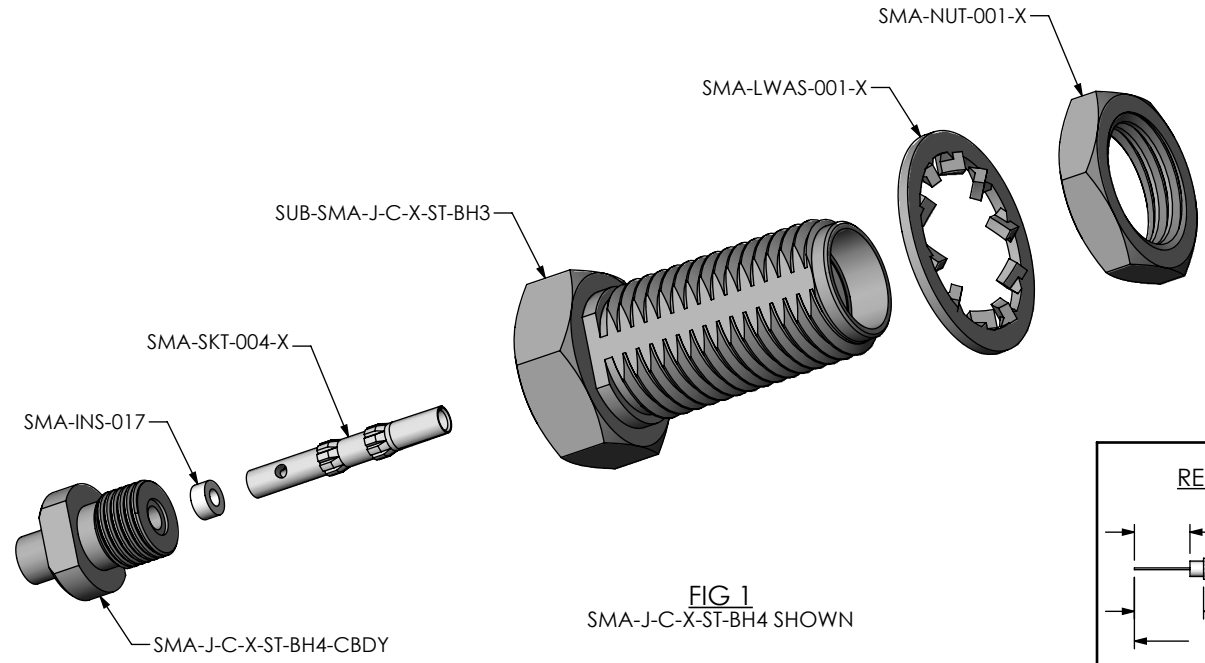
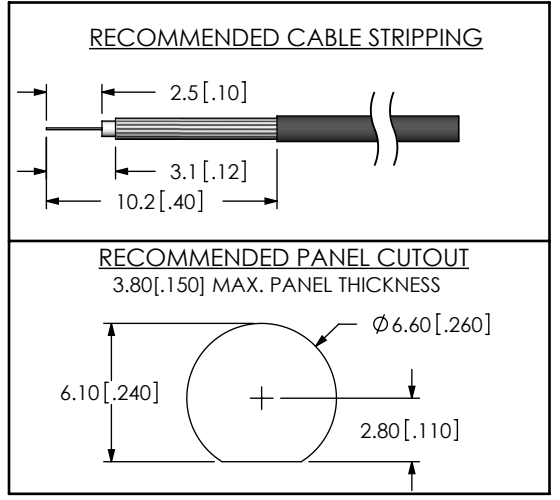

FIG 1
SMA-J-C-X-ST-BH4 SHOWN



- NOTES:
1. $\text{\textcircled{C}}$ REPRESENTS A CRITICAL DIMENSION.
 2. CENTER CONTACT PUSHOUT FORCE = 13.35 N [3 LB] MIN.
 3. SEE SHEET 3 FOR TERMINATION INFORMATION.
 4. NOTE DELETED.
 5. PRODUCT TO BE PACKAGED PER PACKAGING STANDARD CO-RF-WI-3040-M.
 6. RoHS COMPLIANT.
 7. PLATING: -F: .00003" MIN GOLD OVER .000050" MIN NICKEL.
-H: .000030" MIN GOLD OVER .000050" MIN NICKEL.
 8. ASSEMBLY PLATING DESIGNATIONS:
-H: (CENTER CONTACT)-H
(OUTER CONTACT) -F
(REMAINING METAL PARTS) -F

THIS PRODUCT MANUFACTURED WITH LEAD-FREE PROCESSING

UNLESS OTHERWISE SPECIFIED, DIMENSIONS ARE IN MILLIMETERS [INCHES]. TOLERANCES ARE:

| DECIMALS | ANGLES |
|---------------------------|--------|
| .X: ± 0.3 [.01] | 2° |
| .XX: ± 0.13 [.005] | |
| .XXX: ± 0.051 [.0020] | |

PROPRIETARY NOTE
THIS DOCUMENT CONTAINS INFORMATION CONFIDENTIAL AND PROPRIETARY TO SAMTEC, INC. AND SHALL NOT BE REPRODUCED OR TRANSFERRED TO OTHER DOCUMENTS OR DISCLOSED TO OTHERS OR USED FOR ANY PURPOSE OTHER THAN THAT WHICH IT WAS OBTAINED WITHOUT THE EXPRESSED WRITTEN CONSENT OF SAMTEC, INC.



MATERIAL: DO NOT SCALE DRAWING SHEET SCALE: 1:0.333333
SHELL, NUT, WASHER: BRASS
CONTACT: COPPER ALLOY
DIELECTRIC: PTFE

DESCRIPTION:
SMA STR JACK BULKHEAD, MH113- 50 OHM

DWG. NO. **SMA-J-C-X-ST-BH4**

REVISION H

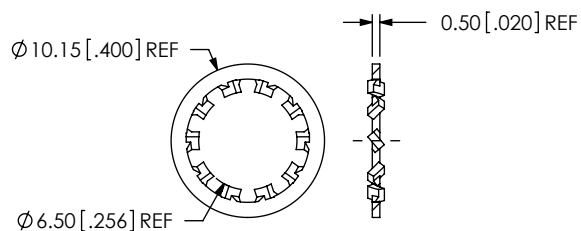

| SAMTEC PART NUMBER | ITEM |
|--------------------|-------------|
| SMA-LWAS-001-X | LOCK WASHER |

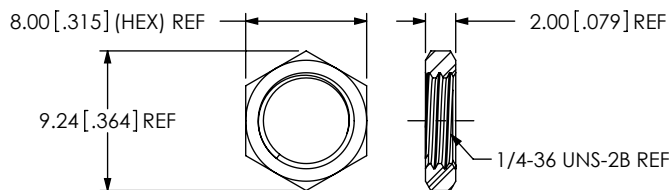

| SAMTEC PART NUMBER | ITEM |
|--------------------|---------|
| SMA-NUT-001-X | HEX NUT |

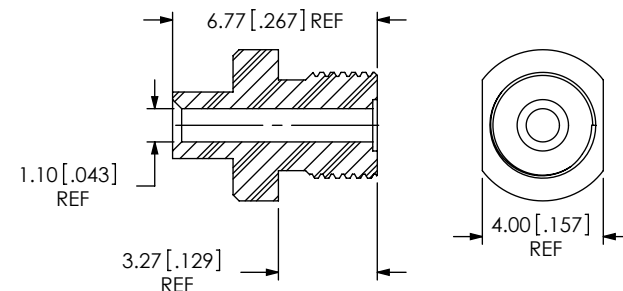

| SAMTEC PART NUMBER | ITEM |
|-----------------------|--------------------|
| SMA-J-C-X-ST-BH4-CBDY | REAR THREADED BODY |

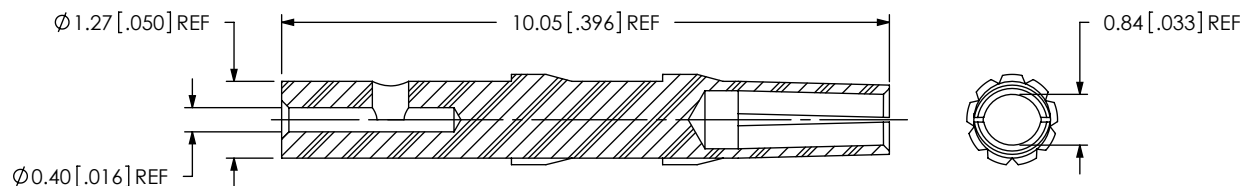

SCALE 8 : 1

| SAMTEC PART NUMBER | ITEM |
|--------------------|--------|
| SMA-SKT-004-X | SOCKET |

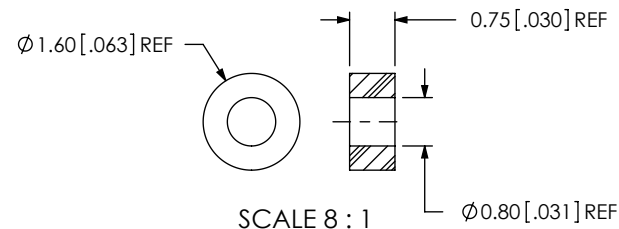

SCALE 8 : 1

| SAMTEC PART NUMBER | ITEM |
|--------------------|-----------|
| SMA-INS-017 | INSULATOR |

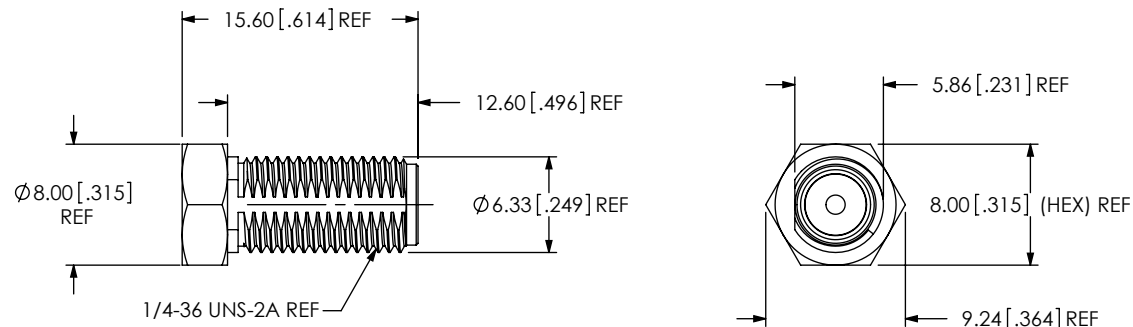

| SAMTEC PART NUMBER | ITEM |
|----------------------|--------------|
| SUB-SMA-J-C-X-ST-BH3 | SUB ASSEMBLY |

F:\DWG\MISC\MKTG\SMA-J-C-X-ST-BH4-MKT.SLDDRW

PROPRIETARY NOTE

THIS DOCUMENT CONTAINS INFORMATION CONFIDENTIAL AND PROPRIETARY TO SAMTEC, INC. AND SHALL NOT BE REPRODUCED OR TRANSFERRED TO OTHER DOCUMENTS OR DISCLOSED TO OTHERS OR USED FOR ANY PURPOSE OTHER THAN THAT WHICH IT WAS OBTAINED WITHOUT THE EXPRESSED WRITTEN CONSENT OF SAMTEC, INC.

DO NOT SCALE DRAWING

SHEET SCALE: 2:1



520 PARK EAST BLVD, NEW ALBANY, IN 47150
 PHONE: 812-944-6733 FAX: 812-948-5047
 e-Mail: info@SAMTEC.com code: 55322

DESCRIPTION:
SMA STR JACK BULKHEAD, MH113- 50 OHM

DWG. NO.
SMA-J-C-X-ST-BH4

BY: R MUSSER 01/28/2008 SHEET 2 OF 3



STRIP AND TIN INNER AND OUTER CONDUCTOR

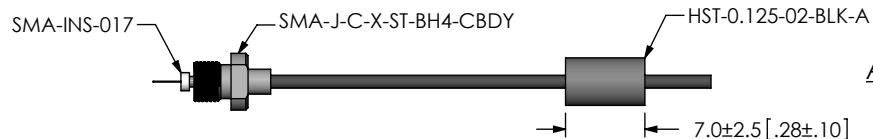

ADD HEAT SHRINK TUBE, REAR THREADED BODY AND INSULATOR

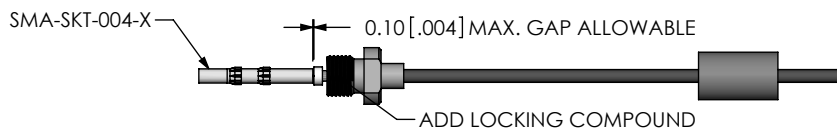

SOLDER SIGNAL SOCKET AND APPLY LOCTITE 680 TO THREADS

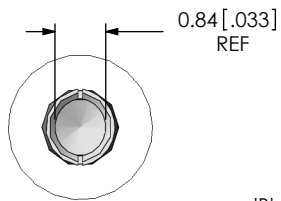

DETAIL 'B'
SCALE 8 : 1

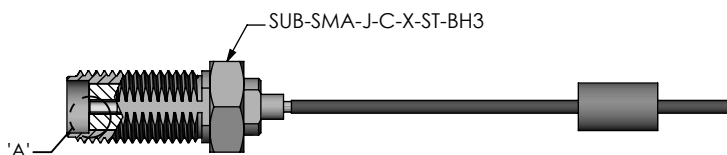
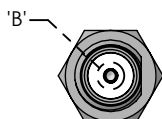

ADD SUB-SMA-J-C-X-ST-BH3 & TIGHTEN REAR-THREADED BODY TO 10 IN-LBS

TIP OF CONTACT TO BE FLUSH WITH REFERENCE PLANE OR RECESSED 0.10 [.004] MAX.

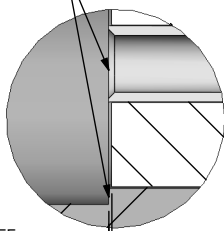

0.05 [.002] REF (TO INSULATOR)
REFERENCE PLANE

DETAIL 'A'
SCALE 8 : 1

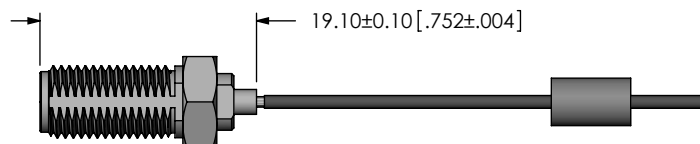

SOLDER SHIELD

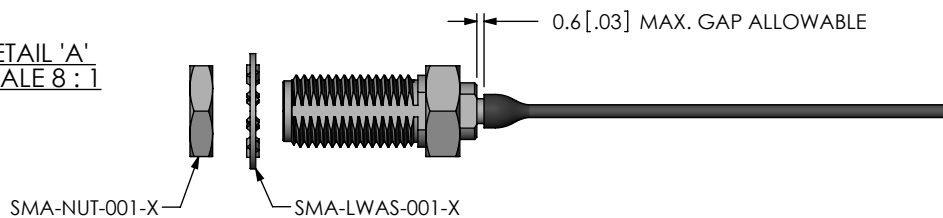

APPLY HEAT SHRINK TUBING

F:\DWG\MISC\MKTG\SMA-J-C-X-ST-BH4-MKT.SLDDRW

PROPRIETARY NOTE
THIS DOCUMENT CONTAINS INFORMATION CONFIDENTIAL AND PROPRIETARY TO SAMTEC, INC. AND SHALL NOT BE REPRODUCED OR TRANSFERRED TO OTHER DOCUMENTS OR DISCLOSED TO OTHERS OR USED FOR ANY PURPOSE OTHER THAN THAT WHICH IT WAS OBTAINED WITHOUT THE EXPRESSED WRITTEN CONSENT OF SAMTEC, INC.



520 PARK EAST BLVD, NEW ALBANY, IN 47150
PHONE: 812-944-6733 FAX: 812-948-5047
e-Mail: info@SAMTEC.com code: 55322

DO NOT SCALE DRAWING

SHEET SCALE: 1.5:1

DESCRIPTION:
SMA STR JACK BULKHEAD, MH113- 50 OHM

DWG. NO.
SMA-J-C-X-ST-BH4

BY: R MUSSER 01/28/2008 SHEET 3 OF 3

| ASSEMBLY OPERATION | START-UP INSPECTION INSPECTED CODE A | IN-PROCESS INSPECTION INSPECTED CODE B |
|--------------------|--------------------------------------|--|
| SOLDERING | | C1 |
| ASSEMBLY | | C2 |