

Pb THIS PRODUCT MANUFACTURED WITH LEAD-FREE PROCESSING

DESIGNED & DIMENSIONED IN MILLIMETERS[INCHES]

SMA-P-C-XX-ST-C47

GENDER -P: PLUG
 TYPE -C: CABLE
 ORIENTATION -ST: STRAIGHT
 TERMINATION -C47: CCA-047-X CABLE
 PLATING SPECIFICATION -HF: 30µ" GOLD CENTER CONTACT, 3µ" GOLD OUTER CONTACT (SEE TABLE 1)

DO NOT SCALE FROM THIS PRINT

TABLE 1		
ITEM	COMPONENT	-HF
1	SUB ASSEMBLY	SUB-SMA-P-C-XX-ST-C47

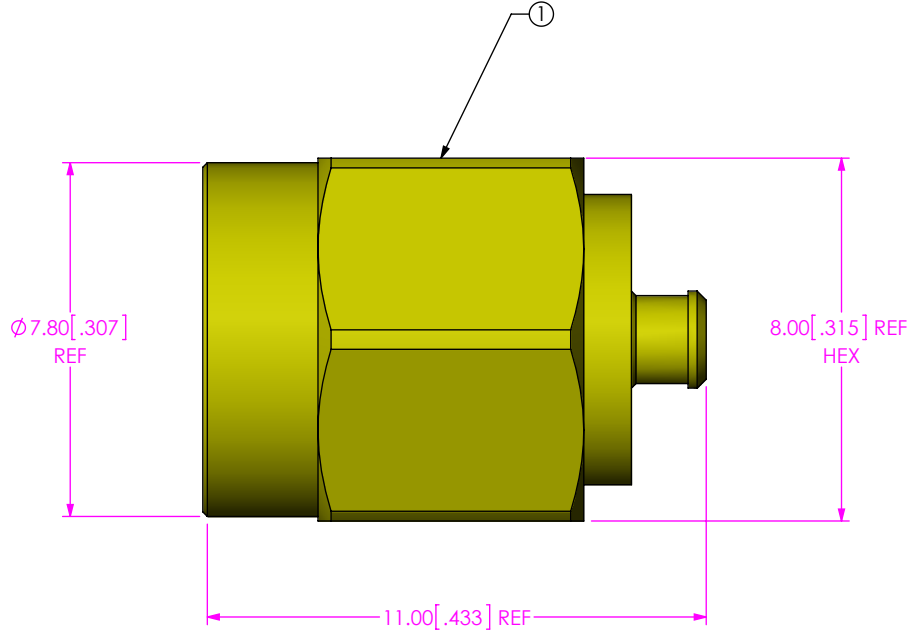

NOTES:

- Ⓢ REPRESENTS A CRITICAL DIMENSION.
- PRODUCT TO BE PACKAGED PER PACKING STANDARD CO-RF-WI-3040-M.

UNLESS OTHERWISE SPECIFIED, DIMENSIONS ARE IN MILLIMETERS.
 TOLERANCES ARE:
 DECIMALS ANGLES
 X.X: ±0.3 [.01] 5°
 X.XX: ±0.13 [.005]
 X.XXX: ±0.051 [.0020]

PROPRIETARY NOTE
 THIS DOCUMENT CONTAINS CONFIDENTIAL AND PROPRIETARY INFORMATION AND ALL DESIGN, MANUFACTURING, REPRODUCTION, USE, PATENT RIGHTS AND SALES RIGHTS ARE EXPRESSLY RESERVED BY SAMTEC, INC. THIS DOCUMENT SHALL NOT BE DISCLOSED, IN WHOLE OR PART, TO ANY UNAUTHORIZED PERSON OR ENTITY NOR REPRODUCED, TRANSFERRED OR INCORPORATED IN ANY OTHER PROJECT IN ANY MANNER WITHOUT THE EXPRESS WRITTEN CONSENT OF SAMTEC, INC.

samtec
 520 PARK EAST BLVD, NEW ALBANY, IN 47150
 PHONE: 812-944-6733 FAX: 812-948-5047
 e-Mail info@SAMTEC.com code 55322

MATERIAL: DO NOT SCALE DRAWING SHEET SCALE: 6:1
 PIN: BeCu
 CABLE BODY, NUT: BRASS
 INSULATOR: PTFE
 GASKET: SILICONE
 C-RING: STAINLESS STEEL

DESCRIPTION: SMA ST PLUG FOR C47 CABLE
 DWG. NO. SMA-P-C-XX-ST-C47
 BY: EMMA CHEN 8/13/2013 SHEET 1 OF 2

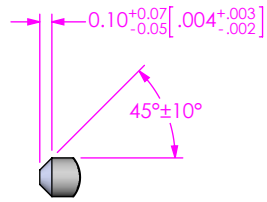

DETAIL 'B'
SCALE 16:1

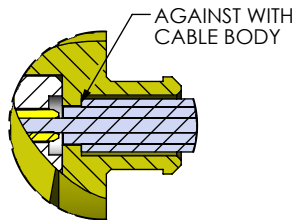

DETAIL 'C'
SCALE 6:1

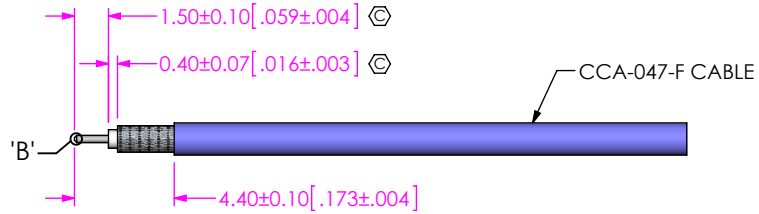

IN-PROCESS 1
STRIP

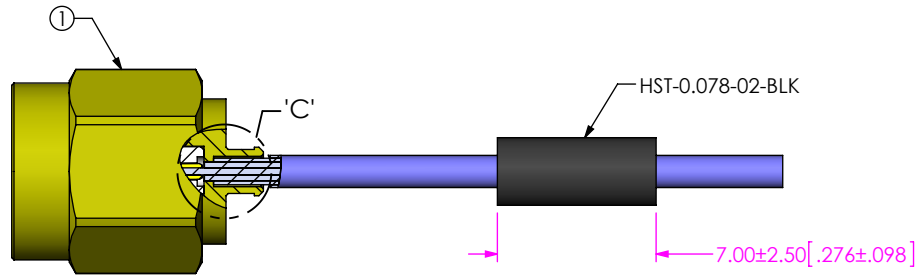

IN-PROCESS 2
ADD SUB ASSEMBLY & HEAT SHRINK TUBE

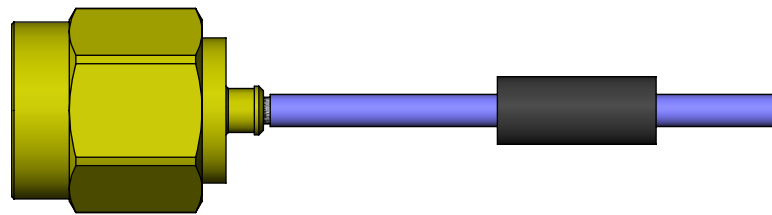

IN-PROCESS 3
SOLDER CABLE TO CABLE BODY

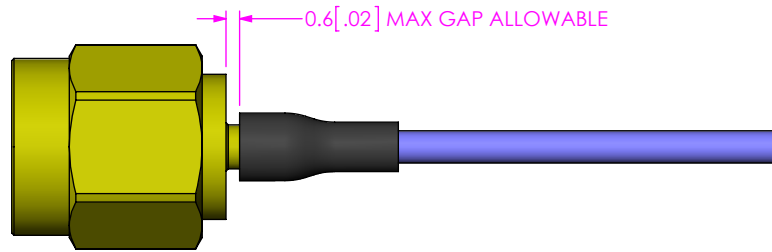

IN-PROCESS 4
APPLY HEAT TO SHRINK TUBING

F:\DWG\MISC\MKTG\SMA-P-C-XX-ST-C47-MKT.SLDDRW

<p>DO NOT SCALE DRAWING</p> <p>SHEET SCALE: 3:1</p>	<p>PROPRIETARY NOTE</p> <p>THIS DOCUMENT CONTAINS CONFIDENTIAL AND PROPRIETARY INFORMATION AND ALL DESIGN, MANUFACTURING, REPRODUCTION, USE, PATENT RIGHTS AND SALES RIGHTS ARE EXPRESSLY RESERVED BY SAMTEC, INC. THIS DOCUMENT SHALL NOT BE DISCLOSED, IN WHOLE OR PART, TO ANY UNAUTHORIZED PERSON OR ENTITY NOR REPRODUCED, TRANSFERRED OR INCORPORATED IN ANY OTHER PROJECT IN ANY MANNER WITHOUT THE EXPRESS WRITTEN CONSENT OF SAMTEC, INC.</p>	 <p>520 PARK EAST BLVD, NEW ALBANY, IN 47150 PHONE: 812-944-6733 FAX: 812-948-5047 e-Mail info@SAMTEC.com code 55322</p>
	<p>DESCRIPTION:</p> <p>SMA ST PLUG FOR C47 CABLE</p>	
	<p>DWG. NO.</p> <p>SMA-P-C-XX-ST-C47</p>	
<p>BY: EMMA CHEN 8/13/2013</p>		<p>SHEET 2 OF 2</p>