

# XQXX-XXX-XXXX-SBL-TED-X-X

ALL DIMENSIONS REF  
DO NOT SCALE  
FROM THIS PRINT

SERIES	"D"	"K"	"L"
EQCD	0.501 [12.73]	0.775 [19.69]	0.590 [14.99]
SQCD	0.625 [15.88]	0.775 [19.69]	0.590 [14.99]
HQCD	0.751 [19.08]	0.775 [19.69]	0.590 [14.99]
EQDP	0.525 [13.34]	0.775 [19.69]	0.590 [14.99]
HQDP	0.800 [20.32]	0.875 [22.23]	0.690 [17.53]
EQSD	0.760 [19.30]	0.775 [19.69]	0.590 [14.99]

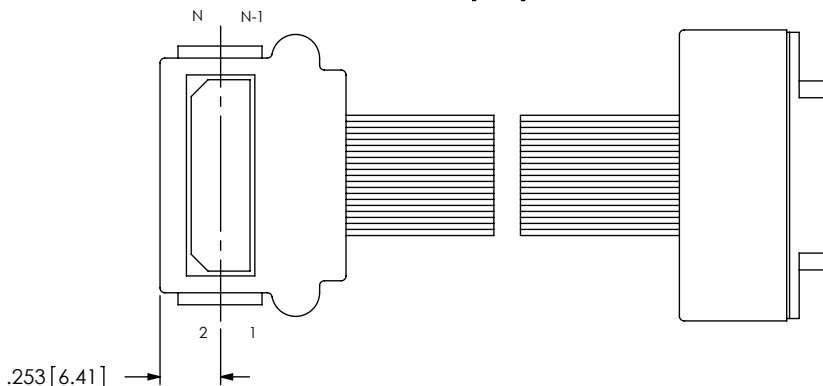
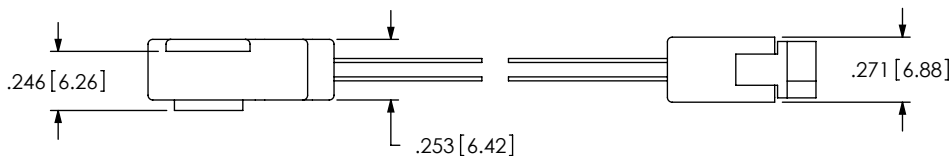
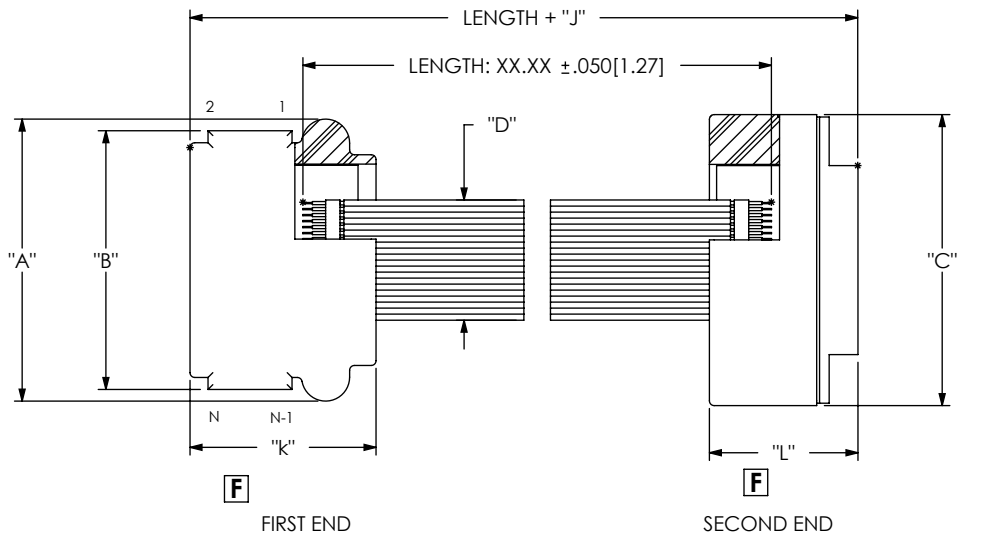

EQCD	SQCD	HQCD	EQDP	HQDP	EQSD	"A"	"B"	"C"	"J"
No. OF POSITIONS	No. OF POSITIONS	No. OF POSITIONS	No. OF POSITIONS	No. OF POSITIONS	No. OF POSITIONS				
N/A	N/A	N/A	N/A	N/A	-020	1.275 [32.39]	1.178 [29.92]	1.213 [30.80]	0.835 [21.21]
N/A	N/A	N/A	N/A	N/A	-040	2.063 [52.39]	1.965 [49.92]	2.000 [50.80]	0.835 [21.21]
-020	-025	-030	-014	N/A	N/A	1.175 [29.85]	1.078 [27.38]	1.213 [30.80]	0.835 [21.21]
-040	-050	-060	-028	N/A	N/A	1.963 [49.85]	1.866 [47.40]	2.000 [50.80]	0.835 [21.21]
-060	-075	-090	-042	N/A	N/A	2.750 [69.85]	2.653 [67.39]	2.788 [70.80]	0.835 [21.21]
-080	-100	-120	-056	N/A	N/A	3.538 [89.85]	3.441 [87.39]	3.575 [90.80]	0.835 [21.21]
N/A	N/A	N/A	N/A	-020	N/A	1.325 [33.66]	1.128 [28.65]	1.515 [38.48]	1.065 [27.05]
N/A	N/A	N/A	N/A	-040	N/A	2.250 [57.15]	2.053 [52.13]	2.303 [58.50]	1.065 [27.05]
N/A	N/A	N/A	N/A	-060	N/A	3.175 [80.65]	2.978 [75.64]	3.090 [78.49]	1.065 [27.05]
N/A	N/A	N/A	N/A	-080	N/A	4.100 [104.14]	3.903 [99.12]	3.878 [98.50]	1.065 [27.05]

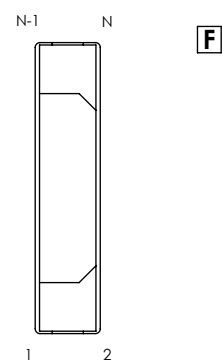

### WIRING OPTION 3 POSITION 1 TO POSITION N-1

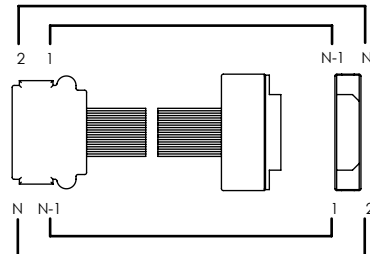

### WIRING OPTION 4 POSITION 1 TO POSITION N

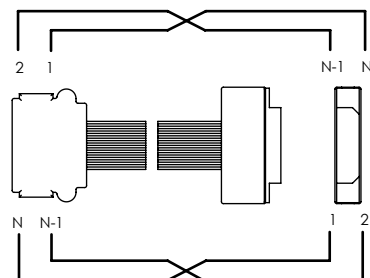

### ONLY APPLICABLE FOR SCREW-DOWN END OPTIONS

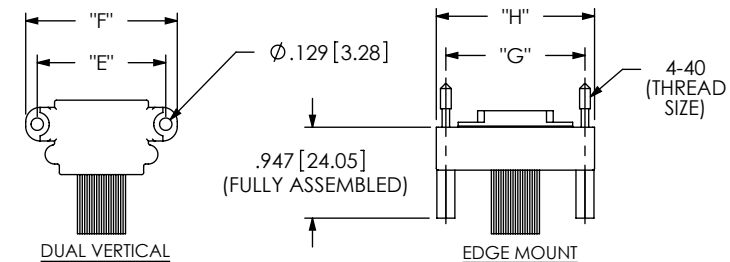

EQCD	SQCD	HQCD	EQDP	HQDP	EQSD	"E"	"F"	"G"	"H"
No. OF POSITIONS	No. OF POSITIONS	No. OF POSITIONS	No. OF POSITIONS	No. OF POSITIONS	No. OF POSITIONS				
N/A	N/A	N/A	N/A	N/A	-020	1.439 [36.55]	1.669 [42.39]	1.449 [36.80]	1.649 [41.88]
N/A	N/A	N/A	N/A	N/A	-040	2.227 [56.55]	2.456 [62.39]	2.237 [56.81]	2.436 [61.87]
-020	-025	-030	-014	N/A	N/A	1.339 [34.00]	1.579 [40.10]	1.449 [36.80]	1.649 [41.88]
-040	-050	-060	-028	N/A	N/A	2.129 [54.00]	2.366 [60.10]	2.237 [56.81]	2.436 [61.87]
-060	-075	-090	-042	N/A	N/A	2.913 [74.00]	3.154 [80.10]	3.024 [76.80]	3.224 [81.88]
-080	-100	-120	-056	N/A	N/A	3.701 [94.00]	3.941 [100.10]	3.812 [96.81]	4.011 [101.88]
N/A	N/A	N/A	N/A	-020	N/A	1.489 [37.80]	1.719 [43.66]	1.751 [44.45]	1.951 [49.56]
N/A	N/A	N/A	N/A	-040	N/A	2.414 [61.32]	2.644 [67.16]	2.539 [64.49]	2.739 [69.57]
N/A	N/A	N/A	N/A	-060	N/A	3.339 [84.81]	3.569 [90.65]	3.326 [84.45]	3.526 [89.56]
N/A	N/A	N/A	N/A	-080	N/A	4.264 [108.31]	4.494 [114.15]	4.111 [104.50]	4.314 [109.58]

PROPRIETARY NOTE  
THIS DOCUMENT CONTAINS INFORMATION CONFIDENTIAL AND PROPRIETARY TO SAMTEC, INC. AND SHALL NOT BE REPRODUCED OR TRANSFERRED TO OTHER DOCUMENTS OR DISCLOSED TO OTHERS OR USED FOR ANY PURPOSE OTHER THAN THAT WHICH IT WAS OBTAINED WITHOUT THE EXPRESSED WRITTEN CONSENT OF SAMTEC, INC.



520 PARK EAST BLVD. NEW ALBANY, IN 47150  
PHONE: 812-944-6733 FAX: 812-948-5047  
e-Mail: info@SAMTEC.com code: 55322

SHEET SCALE: 1.25:1

DESCRIPTION:  
QXX / QTX CABLE ASSEMBLY

DWG. NO.  
XQXX-XXX-XXXX-SBL-TED-X-X

BY: BRATCHER 6/26/2003 SHEET 1 OF 1