

ALL DIMENSIONS REF
DO NOT SCALE
FROM THIS PRINT

SERIES	"D"		"E"	
EQCD	0.501	[12.73]	0.590	[14.99]
SQCD	0.625	[15.88]	0.590	[14.99]
HQCD	0.751	[19.08]	0.590	[14.99]
EQDP	0.525	[13.34]	0.590	[14.99]
HQDP	0.800	[20.32]	0.690	[17.53]
EQSD	0.760	[19.30]	0.590	[14.99]

WIRING OPTION 3
POSITION 1 TO POSITION N-1

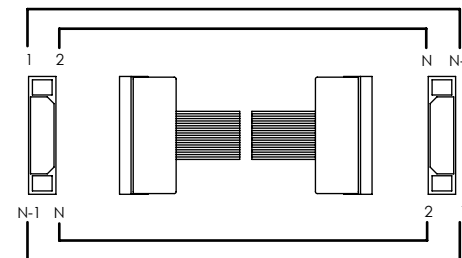

WIRING OPTION 4
POSITION 1 TO POSITION N

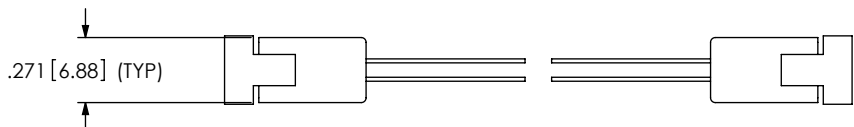
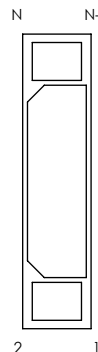
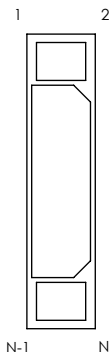
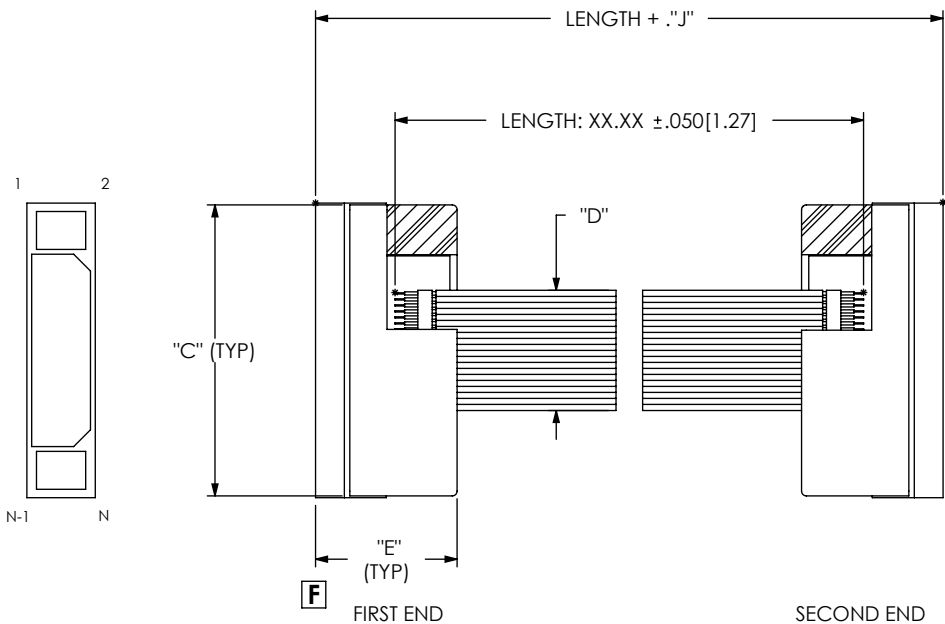
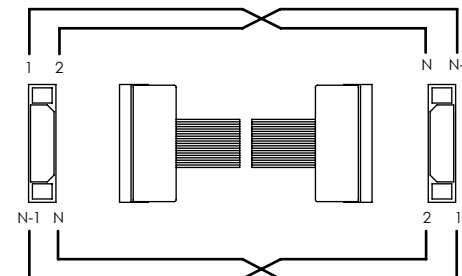

ONLY APPLICABLE FOR SCREW-DOWN END OPTIONS

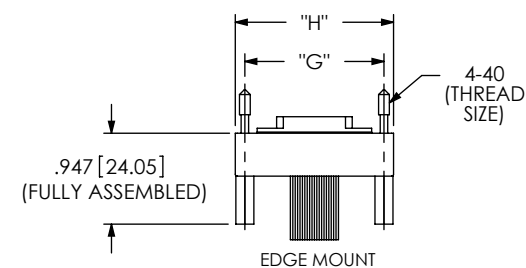

TABLE 1

EQCD	SQCD	HQCD	EQDP	HQDP	EQSD	"C"	"J"
No. OF POSITIONS	No. OF POSITIONS	No. OF POSITIONS	No. OF POSITIONS	No. OF POSITIONS	No. OF POSITIONS		
N/A	N/A	N/A	N/A	N/A	-020	1.213 [30.80]	0.662 [16.81]
N/A	N/A	N/A	N/A	N/A	-040	2.000 [50.80]	0.662 [16.81]
-020	-025	-030	-014	N/A	N/A	1.213 [30.80]	0.662 [16.81]
-040	-050	-060	-028	N/A	N/A	2.000 [50.80]	0.662 [16.81]
-060	-075	-090	-042	N/A	N/A	2.788 [70.80]	0.662 [16.81]
-080	-100	-120	-056	N/A	N/A	3.575 [90.80]	0.662 [16.81]
N/A	N/A	N/A	N/A	-020	N/A	1.515 [38.48]	0.922 [23.42]
N/A	N/A	N/A	N/A	-040	N/A	2.303 [58.50]	0.922 [23.42]
N/A	N/A	N/A	N/A	-060	N/A	3.090 [78.49]	0.922 [23.42]
N/A	N/A	N/A	N/A	-080	N/A	3.878 [98.50]	0.922 [23.42]

TABLE 3

EQCD	SQCD	HQCD	EQDP	HQDP	EQSD	"G"	"H"
No. OF POSITIONS	No. OF POSITIONS	No. OF POSITIONS	No. OF POSITIONS	No. OF POSITIONS	No. OF POSITIONS		
N/A	N/A	N/A	N/A	N/A	-020	1.449 [36.80]	1.649 [41.88]
N/A	N/A	N/A	N/A	N/A	-040	2.237 [56.81]	2.436 [61.87]
-020	-025	-030	-014	N/A	N/A	1.449 [36.80]	1.649 [41.88]
-040	-050	-060	-028	N/A	N/A	2.237 [56.81]	2.436 [61.87]
-060	-075	-090	-042	N/A	N/A	3.024 [76.80]	3.224 [81.89]
-080	-100	-120	-056	N/A	N/A	3.812 [96.81]	4.011 [101.88]
N/A	N/A	N/A	N/A	-020	N/A	1.751 [44.48]	1.951 [49.56]
N/A	N/A	N/A	N/A	-040	N/A	2.539 [64.49]	2.739 [69.57]
N/A	N/A	N/A	N/A	-060	N/A	3.326 [84.48]	3.526 [89.56]
N/A	N/A	N/A	N/A	-080	N/A	4.114 [104.50]	4.314 [109.58]

PROPRIETARY NOTE

THIS DOCUMENT CONTAINS INFORMATION CONFIDENTIAL AND PROPRIETARY TO SAMTEC, INC. AND SHALL NOT BE REPRODUCED OR TRANSFERRED TO OTHER DOCUMENTS OR DISCLOSED TO OTHERS OR USED FOR ANY PURPOSE OTHER THAN THAT WHICH IT WAS OBTAINED WITHOUT THE EXPRESSED WRITTEN CONSENT OF SAMTEC, INC.



520 PARKWAY EAST, BURLINGTON, IN 47 50
PHONE: 812-674-6753 FAX: 812-674-6754
E-MAIL: INFO@SAMTEC.COM Code: 55322

SHEET SCALE: 1.25:1

DESCRIPTION:
QSX / QSX CABLE ASSEMBLY
DWG. NO.
XQXX-XXX-XXXX-SEU-SEU-X-X
BY: BRATCHER 6/20/2003 SHEET 1 OF 1