

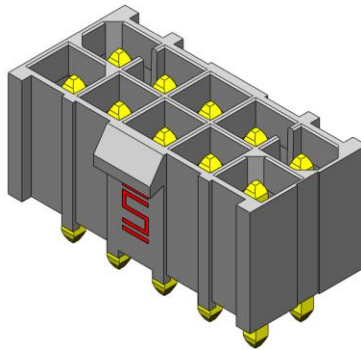

Project: Power Testing	Test Request Number: 203127
Requested by: Eric Mings	Date: 6/7/2013
Part #: PMSD-15-16-SP-12.00-D-LUS/ IPBT-115-H1-T-D	
Part description: 0.165 Socket Discrete Wire Assembly	Technician: Tony Wagoner
Test Start: 7/23/2012	Test Completed: 9/21/2012

SAMTEC POWER CHARACTERIZATION



0.165 Socket Discrete Wire Assembly

**PMSD-15-16-SP-12.00-D-LUS
IPBT-115-H1-T-D**

CERTIFICATION

All instruments and measuring equipment were calibrated to National Institute for Standards and Technology (NIST) traceable standards according to ISO 10012-1 and ANSI/NCSL 2540-1, as applicable.

All contents contained herein are the property of Samtec. No portion of this report, in part or in full shall be reproduced without prior written approval of Samtec.

SCOPE

1. Temperature Rise/Current Carrying Capacity
 - 1.1. To determine the amount of current the device under test (DUT) can safely carry over the operating temperature range of the DUT.
 - 1.2. Contact loading will also be addressed in this document which will determine how much current can be carried as the number of energized contacts is varied.
2. Current Cycling
 - 2.1. To determine the performance of the device under test (DUT) when subjected to the power-on/power-off cycling that heats and cools the DUT in normal everyday use.
 - 2.2. Contact loading will set to 100% throughout the test.

APPLICABLE DOCUMENTS

Standards: EIA Publication 364-70 Temperature Rise
EIA Publication 364-06 Contact Resistance
EIA Publication 364-55 Current Cycling
TLPM-032 Current Carrying Capacity
TLPM-084 Current Cycling
IEC 512-3 Electromechanical Components for Electronic Equipment: Basic Testing Procedures and Measuring Methods, Part 3: Current Carrying Capacity Tests

TEST SAMPLES AND PREPARATION

1. All materials shall be manufactured in accordance with the applicable product specification.
2. All test samples shall be identified and encoded to maintain traceability throughout the test sequences.
3. After soldering, the parts to be used shall be cleaned according to TLWI-0001.
4. All samples shall be visually inspected and cleaned as necessary.
5. Any additional preparation shall be noted in the individual test sequences.
6. Solder Information: Lead Free
7. Re-Flow Time/Temp: See accompanying profile.
8. All products designed to operate mounted on a printed circuits board shall be tested mounted to test boards in accordance with EIA-364-70.

PREPARED TEST SAMPLE

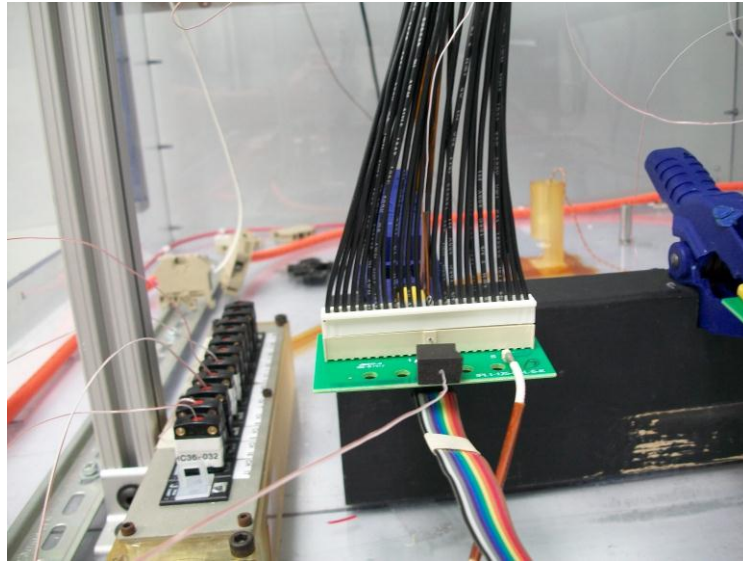

9. The following loading configurations shall be tested for Temperature Rise/Current Carrying Capacity testing of double row connector systems:
- 9.1. Two contacts energized only
 - 9.2. Four contacts energized adjacent to each other
 - 9.3. Six contacts energized adjacent to each other
 - 9.4. Eight contacts energized adjacent to each other
 - 9.5. All contacts energized

- ✦ Indicates energized contacts
- ✦ Indicates thermocouple monitored, energized contacts

Test Condition as in 9.1 above

✦			
✦			

OVEN PROFILE (Soldering Parts to Test Boards)

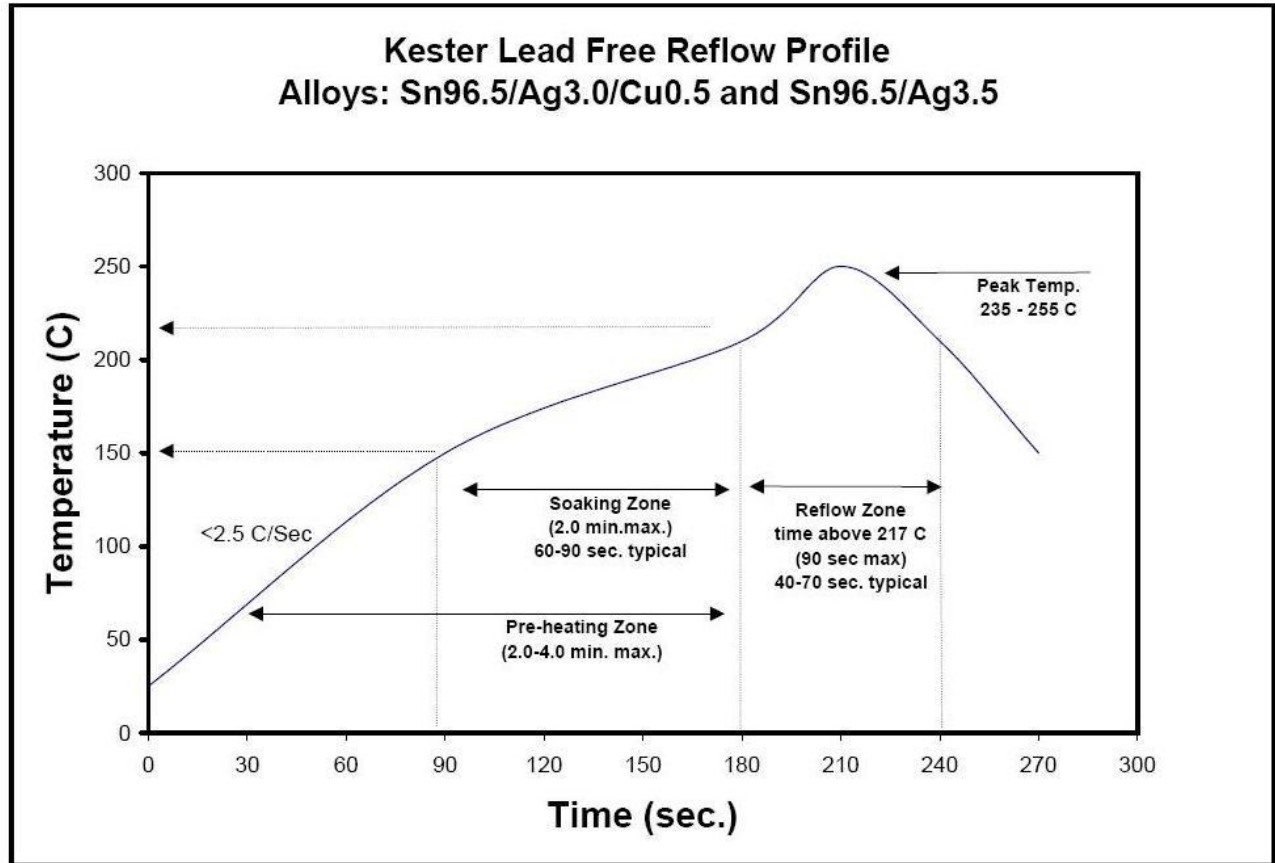



POWER INTEGRITY TEST REPORT

203127

Revision 2

FLOWCHARTS

Current Carrying Capacity

3 Mated Assemblies Each

TEST STEP	GROUP A 3 Mated Assemblies 1 CONTACT POWERED	GROUP B 3 Mated Assemblies 2 CONTACTS POWERED	GROUP C 3 Mated Assemblies 3 CONTACTS POWERED	GROUP D 3 Mated Assemblies 4 CONTACTS POWERED	GROUP E 3 Mated Assemblies ALL CONTACTS POWERED
01	CCC	CCC	CCC	CCC	CCC

(TIN PLATING) - Tabulate calculated current at RT, 65° C, 75° C and 95° C
after derating 20% and based on 105° C

(GOLD PLATING) - Tabulate calculated current at RT, 85° C, 95° C and 115° C
after derating 20% and based on 105° C

CCC, Temp rise = EIA-364-70



POWER INTEGRITY TEST REPORT

203127

Revision 2

TEST PROCEDURES

Part No.	PMSD-15-16-SP-12.00-D-LUS	Mating Part No.	IPBT-115-H1
Sample Size	15	Technician	Tony Wagoner
Start Date	7/23/2012	Complete Date	7/26/2012
Room Ambient	23.3°C	Relative Humidity	55%
Equipment ID#: MO-09, PS-09, TCS(004-050), THL-10			

TEMPERATURE RISE (Current Carrying Capacity, CCC):

1. Thermocouples shall be calibrated in accordance with Samtec documents; TLWI 0003, Thermocouple Welding Procedure and TLWI 0005, Thermocouple Calibration
2. The thermocouples shall be placed at a location to sense the maximum temperature generated during testing.
3. Temperature stability shall be defined as the temperature at which three successive readings, 5 minutes apart, differ not more than 1° C (computer controlled data acquisition). This is the Temperature Rise that the Current Carrying Capacity and De-rating curves are based on.
4. The following loading configurations shall be tested (double for two row systems):
 - a) One contact energized only
 - b) Two contacts energized adjacent to each other
 - c) Three contacts energized adjacent to each other
 - d) Four contacts energized adjacent to each other
 - e) All contacts energized
5. The following loading configurations shall be tested for Temperature Rise/Current Carrying Capacity testing of two row connector systems:
 - a) Two by One contact energized
 - b) Two by Two contacts energized adjacent to each other
 - c) Two by Three contacts energized adjacent to each other
 - d) Two by Four contacts energized adjacent to each other
 - e) All contacts energized
6. Three samples shall be tested for each of the above configurations for a total of eighteen assemblies.
7. Temperature Rise measurements shall be made at 5 different current levels yielding temperature rises in the 10 to 70°C range.
8. The base curve for the Current Rating chart will be derived from the average (maximum) value of three test specimens in accordance with IEC 512-3, Test 5b.



TEST RESULTS

CURRENT CARRYING CAPACITY (CCC) RESULTS

- There was no evidence of physical damage to the test samples as tested.
- The following is a summary of the observed data:

Temperature Rise, CCC at a 20% de-rating

- CCC for a 30°C Temperature Rise -----10.3 A per contact with 2 contacts (2 x 1) powered
- CCC for a 30°C Temperature Rise -----8.4 A per contact with 4 contacts (2 x 2) powered
- CCC for a 30°C Temperature Rise -----7.6 A per contact with 6 contacts (2 x 3) powered
- CCC for a 30°C Temperature Rise -----7.1 A per contact with 8 contacts (2 x 4) powered
- CCC for a 30°C Temperature Rise -----6.0 A per contact with 30 contacts (2 x 15) powered

TEST DATA

CONTACT RESISTANCE @ RATED CURRENT - DC Resistance (DCR)

The following data represents the Voltage drop and Contact Resistance at Rated Current for the 100% energized samples:

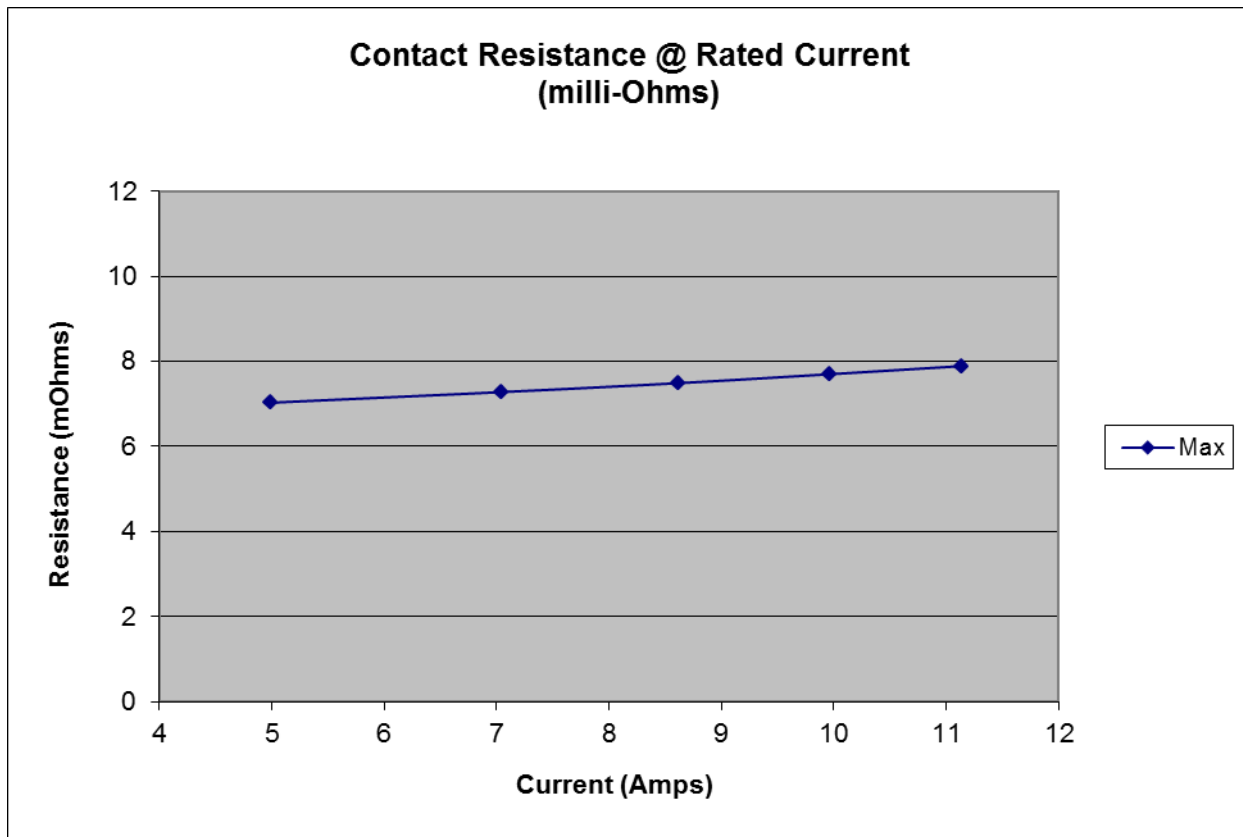

**CONTACT RESISTANCE DATA
ALL CONTACTS ENERGIZED
(mΩ)**

TEST CURRENT AMPS	4.99	7.04	8.62	9.96	11.13
Min	6.55	6.78	6.98	7.15	7.31
Max	7.03	7.28	7.49	7.7	7.89
Avg	6.8	7.04	7.26	7.47	7.67

TEST DATA

VOLTAGE DROP @ RATED CURRENT

The following data represents the Voltage drop at Rated Current for the 100% energized samples:

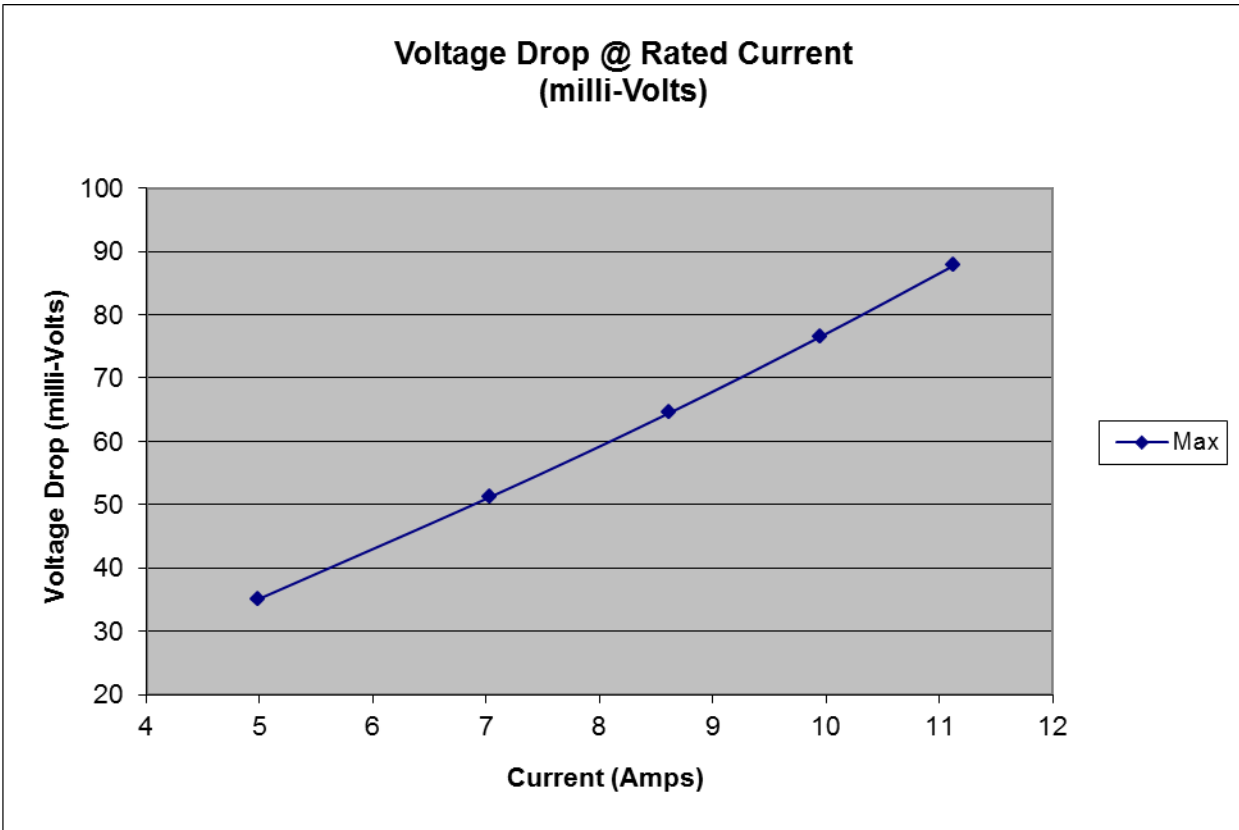

**VOLTAGE DROP DATA
ALL CONTACTS ENERGIZED
(mV)**

TEST CURRENT AMPS	4.99	7.04	8.62	9.96	11.13
Min	32.7	47.7	60.19	71.18	81.37
Max	35.09	51.27	64.54	76.66	87.84
Avg	33.88	49.44	62.37	74.08	84.96

CURRENT CARRYING CAPACITY DATA

203127-Crimp
2 (2x1) Contacts in Series
PMSD-15-16-SP-12.00-D-LUS/IPBT-115-H1-T-D

Current Rating per Contact (30 Deg. Rise, 20% Derated) = 10.3 Amps

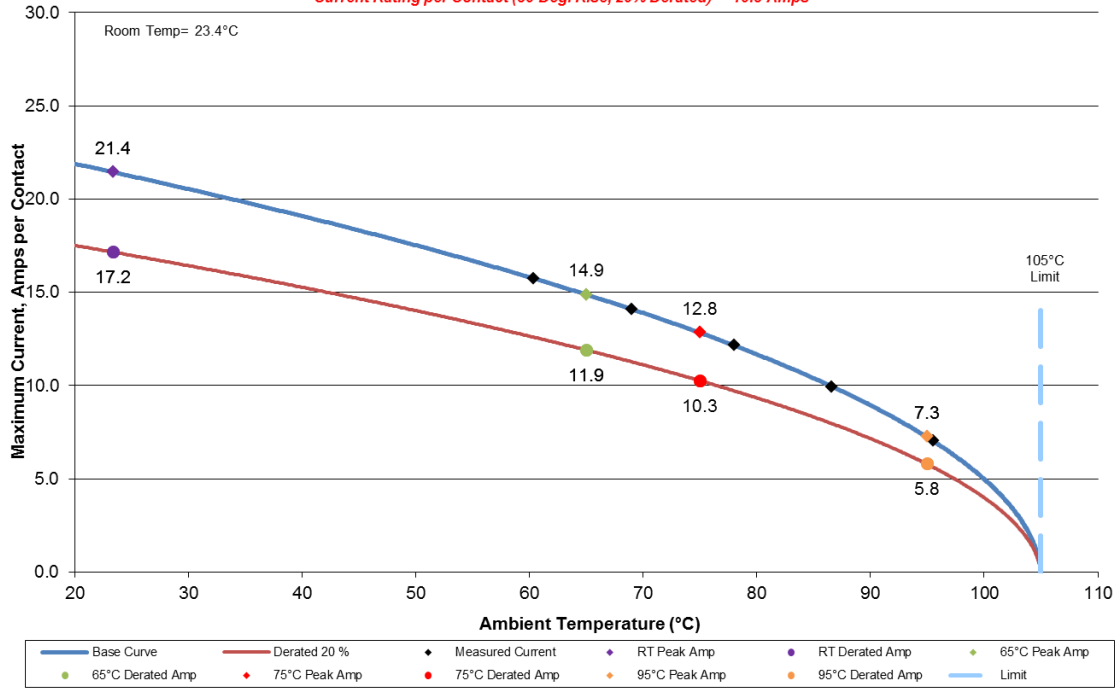

203127-Crimp
2 (2x1) Contacts in Series
PMSD-15-16-SP-12.00-D-LUS/IPBT-115-H1-T-D

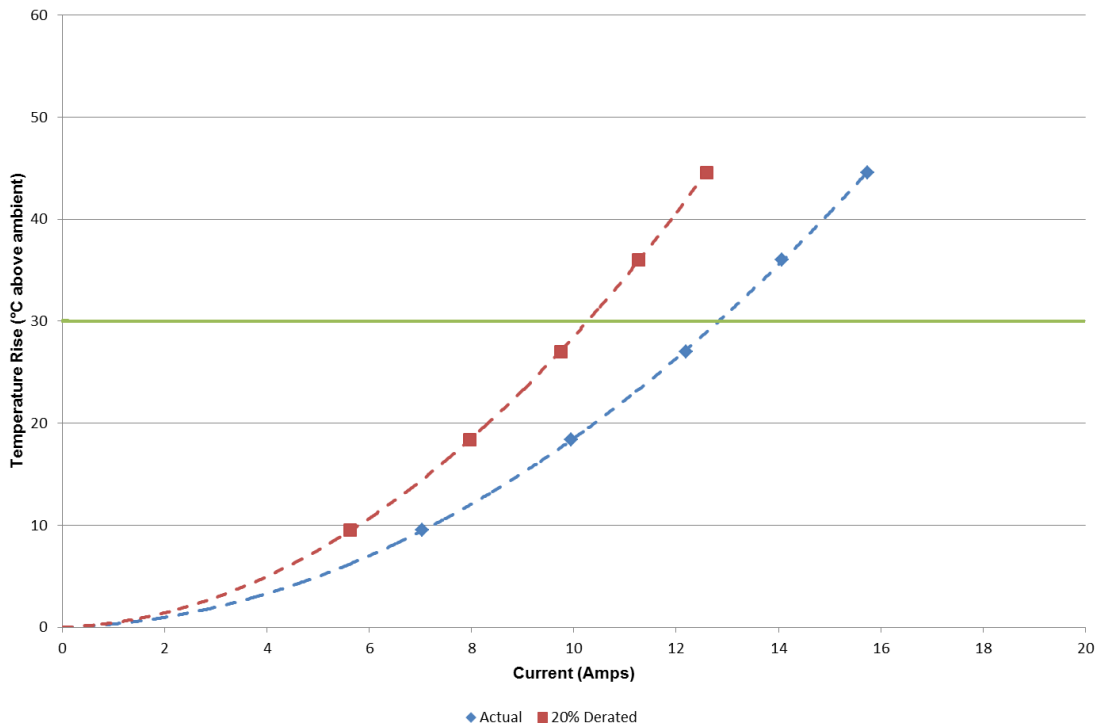



POWER INTEGRITY TEST REPORT

203127

Revision 2

TEMPERATURE RISE DATA TWO CONTACTS ENERGIZED (Degrees Celsius above ambient)

TEST CURRENT AMPS	7.03	9.95	12.19	14.07	15.74
Sample 1	9.4	18.4	27.3	36.5	45.3
Sample 2	9.8	19	27.7	36.7	45.5
Sample 3	9.2	17.7	26.1	34.8	43.1
Min	9.2	17.7	26.1	34.8	43.1
Max	9.8	19	27.7	36.7	45.5
Avg	9.47	18.37	27.03	36	44.63

Double Row
Configuration

- ✦ Indicates energized contacts
- ✦ Indicates thermocouple monitored, energized contacts

✦			
✦			

203127-Crimp
4 (2x2) Contacts in Series
PMSD-15-16-SP-12.00-D-LUS/IPBT-115-H1-T-D

Current Rating per Contact (30 Deg. Rise, 20% Derated) = 8.4 Amps

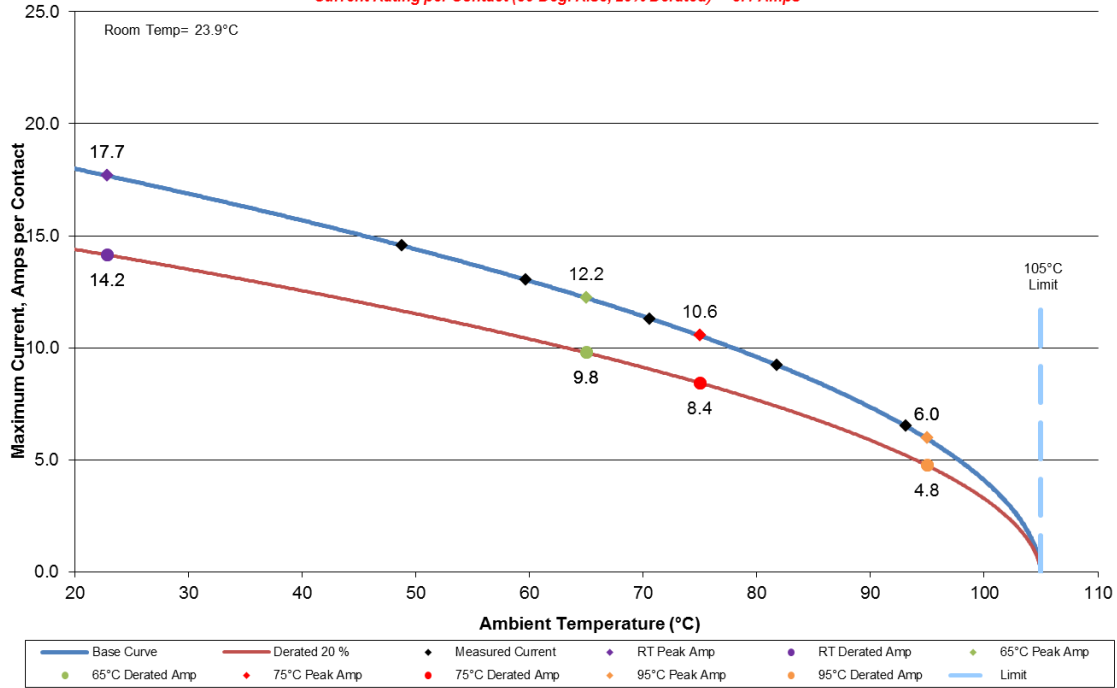

203127-Crimp
4 (2x2) Contacts in Series
PMSD-15-16-SP-12.00-D-LUS/IPBT-115-H1-T-D

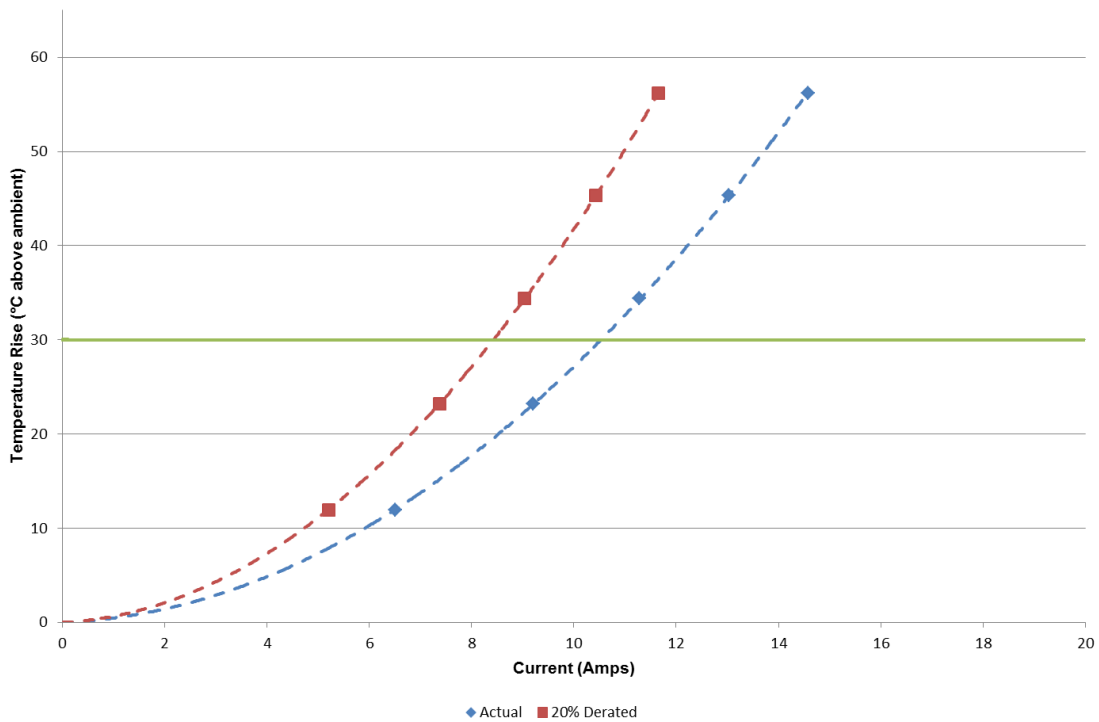

**TEMPERATURE RISE DATA
FOUR CONTACTS ENERGIZED
(Degrees Celsius above ambient)**

TEST CURRENT AMPS	6.51	9.21	11.29	13.04	14.57
Sample 4	12.1	23.5	35.2	46.5	57.6
Sample 5	12	23.4	34.3	45.1	55.8
Sample 6	11.6	22.6	33.7	44.4	55.1
Min	11.6	22.6	33.7	44.4	55.1
Max	12.1	23.5	35.2	46.5	57.6
Avg	11.9	23.17	34.4	45.33	56.17

✦ Indicates energized contacts

✦ Indicates thermocouple monitored, energized contacts

✦	✦		
✦	✦		

203127-Crimp
6 (2x3) Contacts in Series
PMSD-15-16-SP-12.00-D-LUS/IPBT-115-H1-T-D

Current Rating per Contact (30 Deg. Rise, 20% Derated) = 7.6 Amps

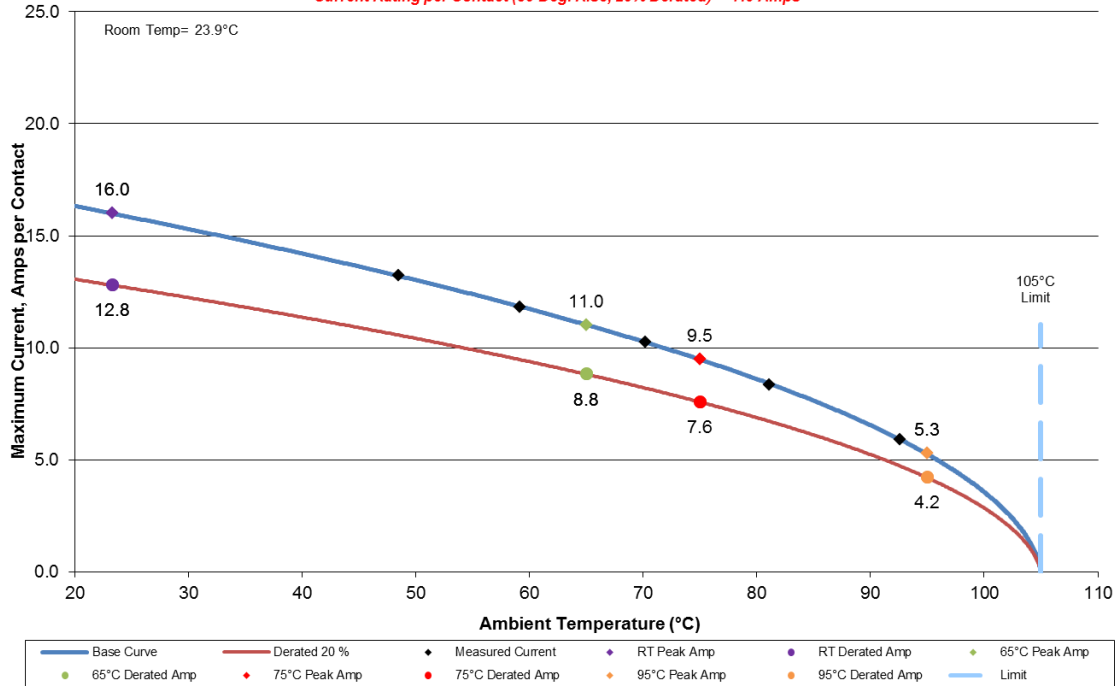

203127-Crimp
6 (2x3) Contacts in Series
PMSD-15-16-SP-12.00-D-LUS/IPBT-115-H1-T-D

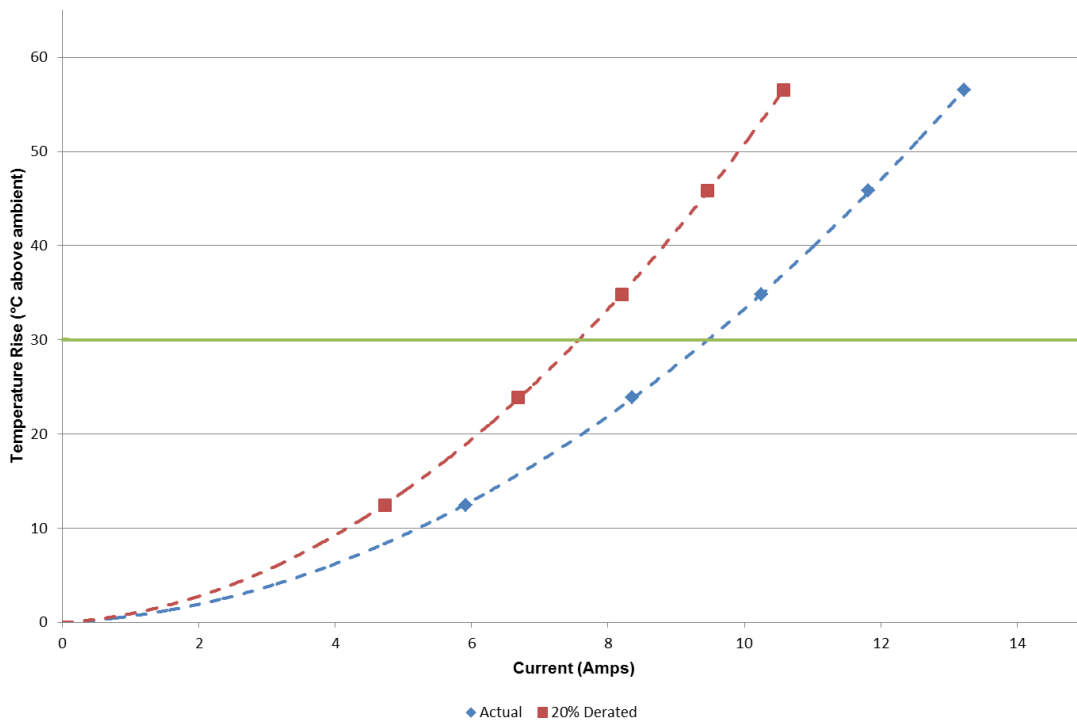



POWER INTEGRITY TEST REPORT

203127

Revision 2

TEMPERATURE RISE DATA SIX CONTACTS ENERGIZED (Degrees Celsius above ambient)

TEST CURRENT AMPS	5.91	8.36	10.25	11.82	13.23
Sample 7	12.6	23.1	34	44.7	55.6
Sample 8	14.5	23.6	34.1	44.9	54.8
Sample 9	13	25	36.4	47.8	59.2
Min	12.6	23.1	34	44.7	54.8
Max	14.5	25	36.4	47.8	59.2
Avg	13.37	23.9	34.83	45.8	56.53

✦ Indicates energized contacts

✦ Indicates thermocouple monitored, energized contacts

✦	✦	✦	
✦	✦	✦	

203127-Crimp
8 (2x4) Contacts in Series
PMSD-15-16-SP-12.00-D-LUS/IPBT-115-H1-T-D

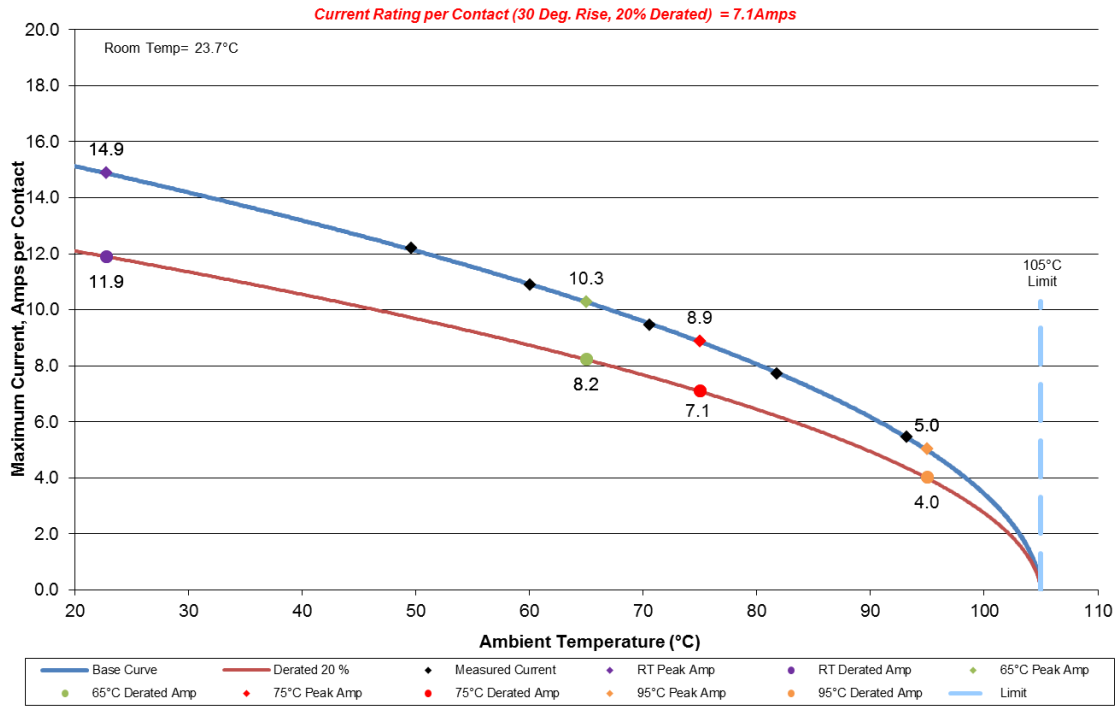

203127-Crimp
8 (2x4) Contacts in Series
PMSD-15-16-SP-12.00-D-LUS/IPBT-115-H1-T-D

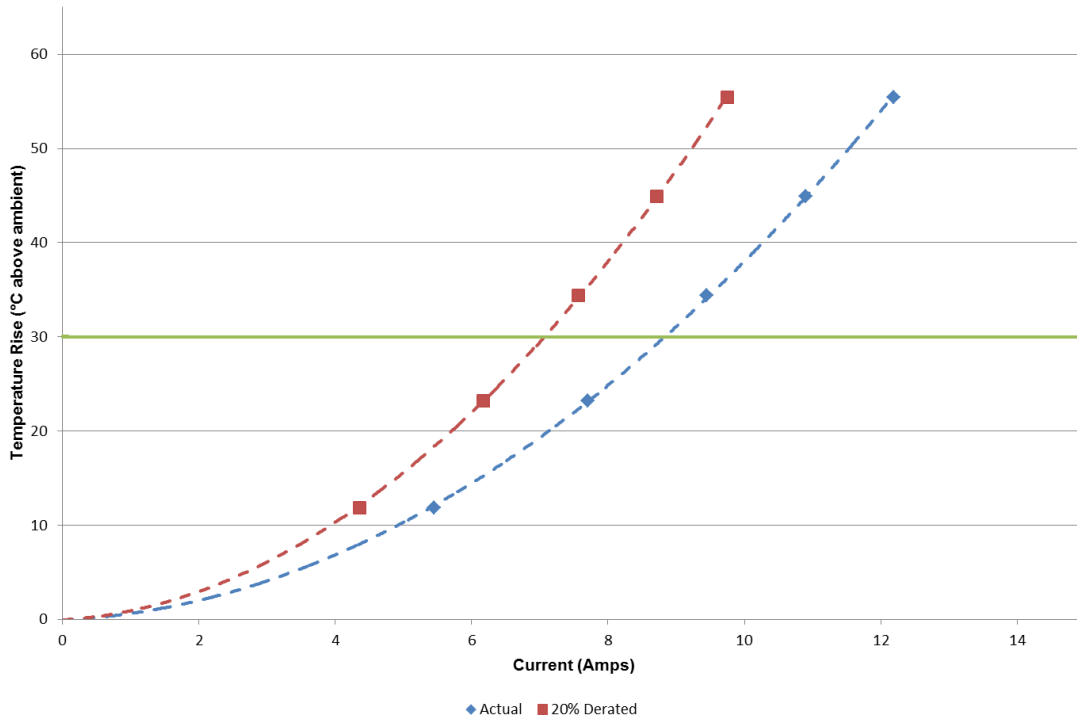

**TEMPERATURE RISE DATA
EIGHT CONTACTS ENERGIZED
(Degrees Celsius above ambient)**

TEST CURRENT AMPS	5.45	7.71	9.45	10.9	12.19
Sample 10	11.8	22.9	33.9	43.7	53.6
Sample 11	11.8	23.3	34.5	45.1	55.9
Sample 12	11.9	23.4	34.9	45.8	56.6
Min	11.8	22.9	33.9	43.7	53.6
Max	11.9	23.4	34.9	45.8	56.6
Avg	11.83	23.2	34.43	44.87	55.37

✦ Indicates energized contacts

✦ Indicates thermocouple monitored, energized contacts

✦	✦	✦	✦
✦	✦	✦	✦

203127-Crimp
30 (2x15) Contacts in Series
PMSD-15-16-SP-12.00-D-LUS/IPBT-115-H1-T-D

Current Rating per Contact (30 Deg. Rise, 20% Derated) = 6.0 Amps

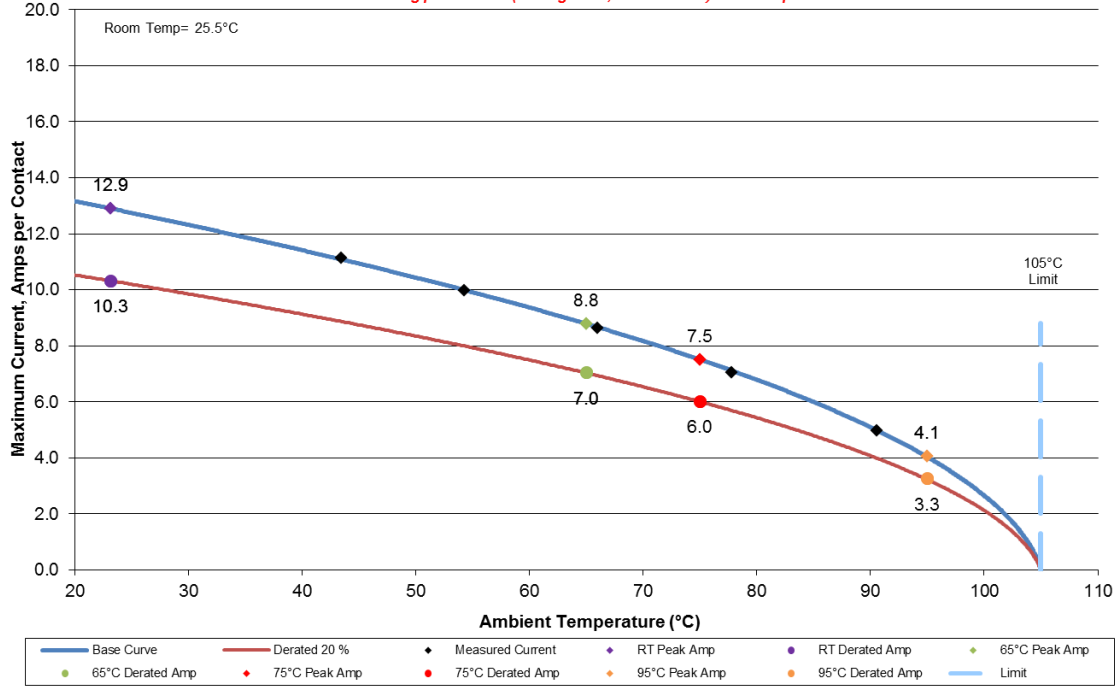

203127-Crimp
30 (2x15) Contacts in Series
PMSD-15-16-SP-12.00-D-LUS/IPBT-115-H1-T-D

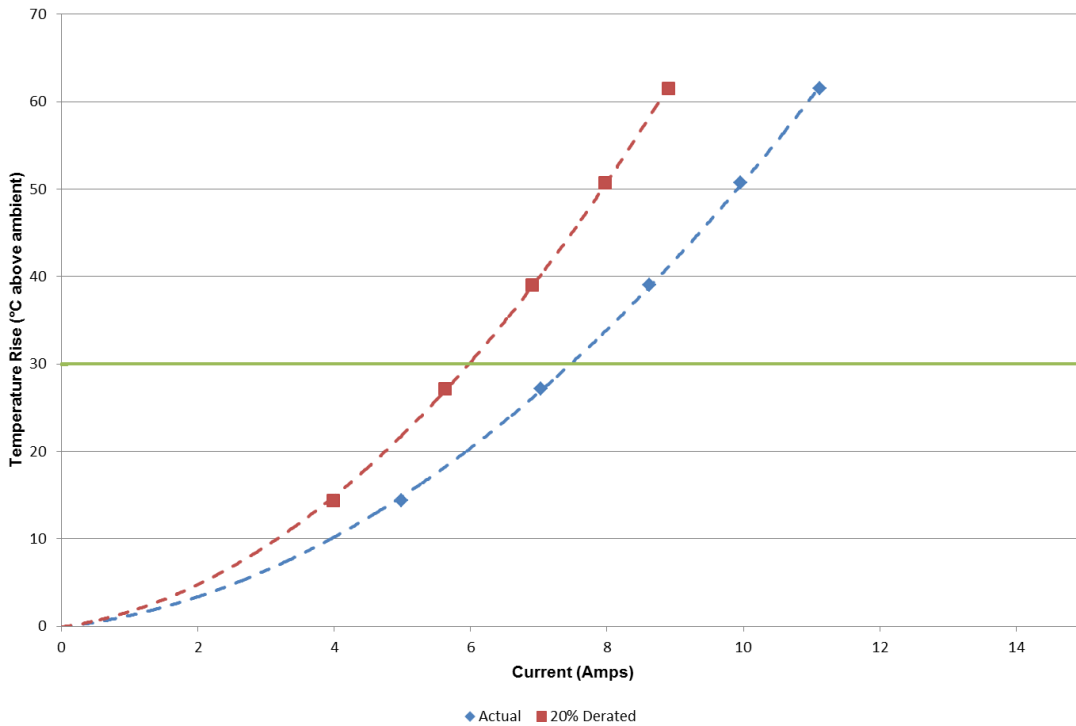

**TEMPERATURE RISE DATA
ALL CONTACTS ENERGIZED
(Degrees Celsius above ambient)**

TEST CURRENT AMPS	4.99	7.04	8.62	9.96	11.13
Sample 13	14.7	28	39.9	51.8	63
Sample 14	13.9	26.1	37.7	49.1	59.7
Sample 15	14.5	27.4	39.4	51.1	61.8
Min	13.9	26.1	37.7	49.1	59.7
Max	14.7	28	39.9	51.8	63
Avg	14.37	27.17	39	50.67	61.5

- ✦ Indicates energized contacts
- ✦ Indicates thermocouple monitored, energized contacts

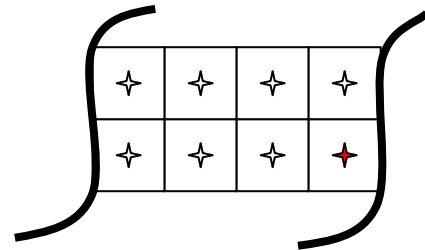



EQUIPMENT AND CALIBRATION SCHEDULES

Equipment #: MO-09

Description: Model 2700 Multimeter/Data Acquisition System (Integra Series)

Manufacturer: Keithley

Model: 2700

Serial #: 0916761

Accuracy: See Manual

... Last Cal: 10/1/2012, Next Cal: 10/1/2013

Equipment #: PS-09

Description: 60V, 50A, 1000W System DC Power Supply

Manufacturer: Agilent Technologies

Model: 6032A

Serial #: US38322853

Accuracy: See Manual

Equipment #: RS-01

Description: Shunt

Manufacturer: Vishay

Model: VCS202

Serial #: VCS202

Accuracy: $\pm 1\%$ RDG

... Last Cal: 5/30/2012, Next Cal: 5/30/2013

Equipment #: TC111307-(TCS-005-048)

Description: Calibrated Thermocouples

Manufacturer: Samtec, Inc.

Model:

Serial #:

Accuracy:

... Last Cal: 5/16/2012, Next Cal: 5/16/2013