

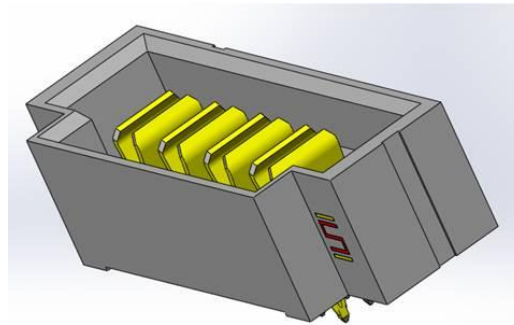

Project Number: 236724		Tracking Code: 236724 Power Test Report Rev 5	
Requested by: Greg Hickerson		Date: 5/30/2013	Product Rev:
Part #: UPT-08-03.0-03-T-PV/UPS-08-04.0-03-T-PV		Lot #: N/A	Tech: Tony Wagoner Eng: Eric Mings
Part description: UPT/UPS			Qty to test: 15
Test Start: 02/28/2013	Test Completed: 03/22/2013		

SAMTEC POWER CHARACTERIZATION

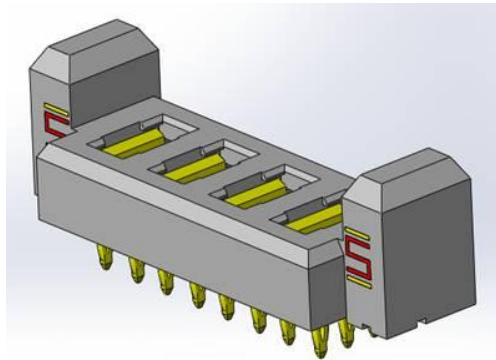

PART DESCRIPTION

UPT-08-03.0-03-T-PV/UPS-08-04.0-03-T-PV

CERTIFICATION

All instruments and measuring equipment were calibrated to National Institute for Standards and Technology (NIST) traceable standards according to ISO 10012-1 and ANSI/NCSL 2540-1, as applicable.

All contents contained herein are the property of Samtec. No portion of this report, in part or in full shall be reproduced without prior written approval of Samtec.

SCOPE

1. Temperature Rise/Current Carrying Capacity
 - 1.1. To determine the amount of current the device under test (DUT) can safely carry over the operating temperature range of the DUT.
 - 1.2. Contact loading will also be addressed in this document which will determine how much current can be carried as the number of energized contacts is varied.
2. Current Cycling
 - 2.1. To determine the performance of the device under test (DUT) when subjected to the power-on/power-off cycling that heats and cools the DUT in normal everyday use.
 - 2.2. Contact loading will set to 100% throughout the test.

APPLICABLE DOCUMENTS

Standards: EIA Publication 364-70 Temperature Rise
EIA Publication 364-06 Contact Resistance
EIA Publication 364-55 Current Cycling
TLPM-032 Current Carrying Capacity
TLPM-084 Current Cycling
IEC 512-3 Electromechanical Components for Electronic Equipment: Basic Testing Procedures and Measuring Methods, Part 3: Current Carrying Capacity Tests

TEST SAMPLES AND PREPARATION

- 1) All materials shall be manufactured in accordance with the applicable product specification.
- 2) All test samples shall be identified and encoded to maintain traceability throughout the test sequences.
- 3) After soldering, the parts to be used shall be cleaned according to TLWI-0001.
- 4) All samples shall be visually inspected and cleaned as necessary.
- 5) Any additional preparation shall be noted in the individual test sequences.
- 6) Solder Information: Lead Free
- 7) Re-Flow Time/Temp: See accompanying profile.
- 8) All products designed to operate mounted on a printed circuits board shall be tested mounted to test boards in accordance with EIA-364-70.

PREPARED TEST SAMPLE

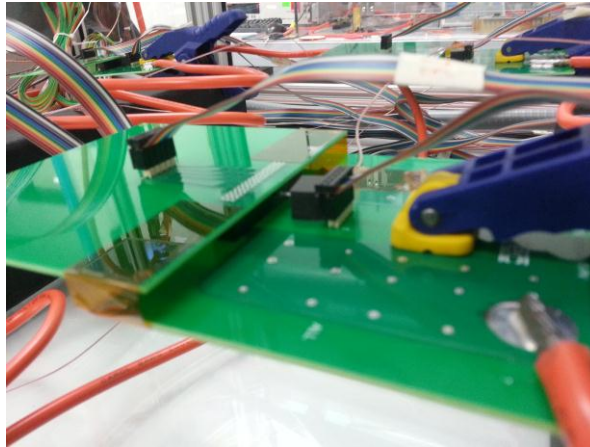

- 9) The following loading configurations shall be tested for Temperature Rise/Current Carrying Capacity testing of single row connector systems:
- a. One contact energized only
 - b. Two contacts energized adjacent to each other
 - c. Three contacts energized adjacent to each other
 - d. Four contacts energized adjacent to each other
 - e. All contacts energized

✦ Indicates energized contacts

✦ Indicates thermocouple monitored, energized contacts

10) For Current Cycling, only 100 % loading will be tested.

Test Condition as in 9.1 above



OVEN PROFILE (Soldering Parts to Test Boards)

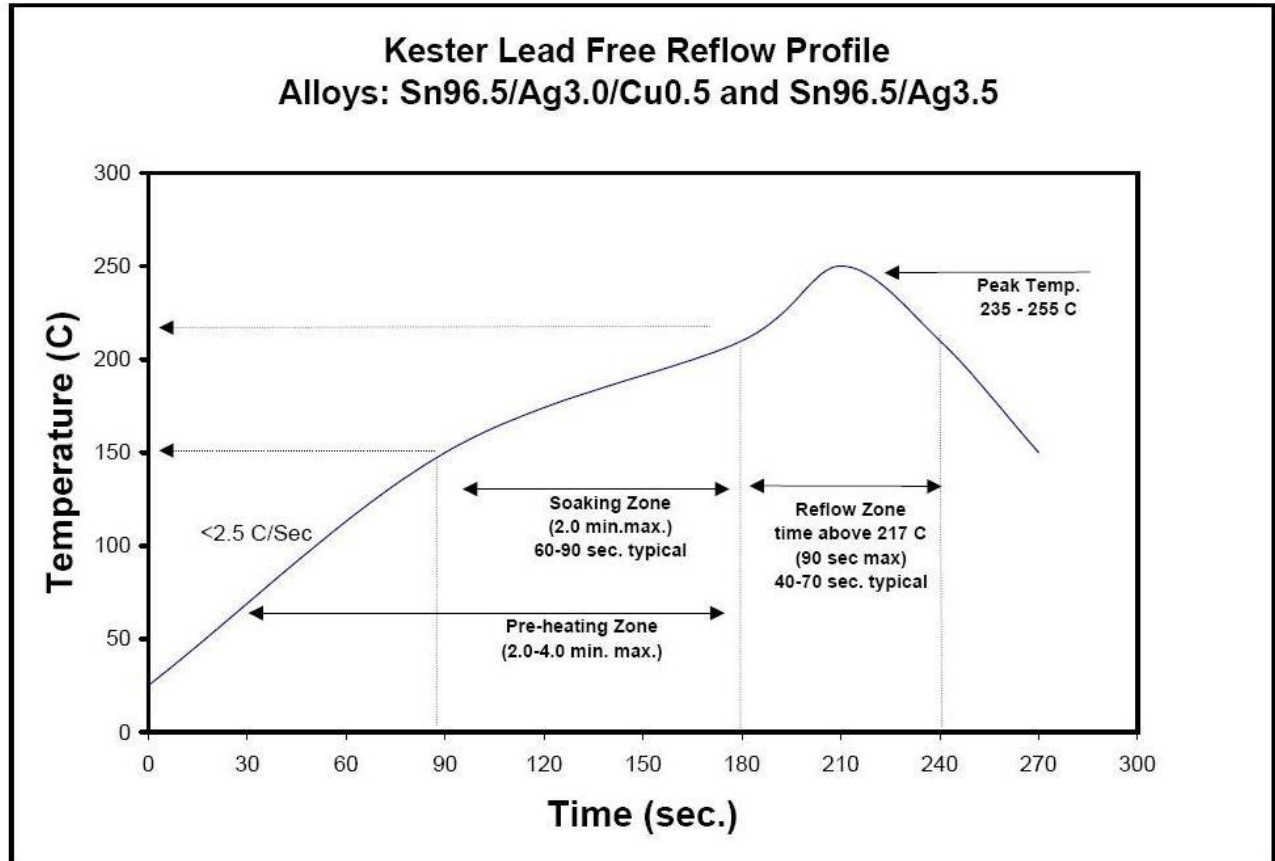



POWER INTEGRITY TEST REPORT

236724

Revision 5

FLOWCHARTS

Current Carrying Capacity

3 Mated Assemblies Each

TEST STEP	GROUP A 3 Mated Assemblies 1 CONTACT POWERED	GROUP B 3 Mated Assemblies 2 CONTACTS POWERED	GROUP C 3 Mated Assemblies 3 CONTACTS POWERED	GROUP D 3 Mated Assemblies 4 CONTACTS POWERED	GROUP E 3 Mated Assemblies ALL CONTACTS POWERED
01	CCC	CCC	CCC	CCC	CCC

(TIN PLATING) - Tabulate calculated current at RT, 65° C, 75° C and 95° C after derating 20% and based on 105° C

(GOLD PLATING) - Tabulate calculated current at RT, 85° C, 95° C and 115° C after derating 20% and based on 105° C

Current Cycling

TEST STEP	GROUP A 8 Mated Assemblies ALL CONTACTS POWERED
01	Current Cycle, 500 cycles at 125% of Rated current

Current Cycle = EIA 364-55, Condition "B", Method #4

Test at Current 125% of Rated Current

Measure at 45 minutes into ON time of cycle

Measure Voltage Drop on 5 random contacts



POWER INTEGRITY TEST REPORT

236724

Revision 5

TEST PROCEDURES

Part No.	UPT-08-03.0-03-T-PV	Mating Part No.	UPS-08-04.0-03-T-PV
Sample Size	15	Technician	Tony Wagoner
Start Date	02/28/2013	Complete Date	03/22/2013
Room Ambient	22°C	Relative Humidity	39%
Equipment ID#: MO-04, PS-07, MO-09, PS-09, 236724-(001 - 015)			

TEMPERATURE RISE (Current Carrying Capacity, CCC):

- 1) Thermocouples shall be calibrated in accordance with Samtec documents; TLWI 0003, Thermocouple Welding Procedure and TLWI 0005, Thermocouple Calibration
- 2) The thermocouples shall be placed at a location to sense the maximum temperature generated during testing.
- 3) Temperature stability shall be defined as the temperature at which three successive readings, 5 minutes apart, differ not more than 1° C (computer controlled data acquisition). This is the Temperature Rise that the Current Carrying Capacity and De-rating curves are based on.
- 4) The following loading configurations shall be tested (double for two row systems):
 - a. One contact energized only
 - b. Two contacts energized adjacent to each other
 - c. Three contacts energized adjacent to each other
 - d. Four contacts energized adjacent to each other
 - e. All contacts energized
- 5) The following loading configurations shall be tested for Temperature Rise/Current Carrying Capacity testing of two row connector systems:
 - a. Two by One contact energized
 - b. Two by Two contacts energized adjacent to each other
 - c. Two by Three contacts energized adjacent to each other
 - d. Two by Four contacts energized adjacent to each other
 - e. All contacts energized
- 6) Three samples shall be tested for each of the above configurations for a total of eighteen assemblies.
- 7) Temperature Rise measurements shall be made at 5 different current levels yielding temperature rises in the 10 to 70°C range.
- 8) The base curve for the Current Rating chart will be derived from the average (maximum) value of three test specimens in accordance with IEC 512-3, Test 5b.



**POWER INTEGRITY TEST
REPORT**

236724

Revision 5

Part No.	UPT-08-03.0-03-T-PV	Mating Part No.	UPS-08-04.0-03-T-PV
Sample Size	15	Technician	Tony Wagoner
Start Date	02/28/2013	Complete Date	03/22/2013
Room Ambient	22°C	Relative Humidity	39%
Equipment ID#: MO-04, PS-07, MO-09, PS-09, 236724-(001 - 015)			

CURRENT CYCLING

1. Samples shall be prepared and tested as above (paragraph 14.5).
2. Current Cycling shall be performed in accordance with EIA-364-55, Test Condition
3. Testing shall be as follows:
 - 3.1. Test Current: **TEST CURRENT**(125% of 30°C Rating)
 - 3.2. "ON" Time: 45 Minutes
 - 3.3. "OFF" Time: 15 Minutes
 - 3.4. Number of Cycles: 500
 - 3.5. Measurements: 40 minutes into ON cycle
 - 3.5.1. Temperature
 - 3.5.2. Voltage Drop/Contact Resistance
4. Temperature vs. Number of Cycles and Voltage Drop vs. Number of Cycles shall be measured and recorded.

TEST RESULTS

CURRENT CARRYING CAPACITY (CCC) RESULTS

- There was no evidence of physical damage to the test samples as tested.
- The following is a summary of the observed data:

Temperature Rise, CCC at a 20% de-rating

- CCC for a 30°C Temperature Rise -----24.8 A per contact with 1 contacts (1 x 1) powered
- CCC for a 30°C Temperature Rise -----21.1 A per contact with 2 contacts (1 x 2) powered
- CCC for a 30°C Temperature Rise -----18.7 A per contact with 3 contacts (1 x 3) powered
- CCC for a 30°C Temperature Rise -----17.6 A per contact with 4 contacts (1 x 4) powered
- CCC for a 30°C Temperature Rise -----14.4 A per contact with 8 contacts (1 x 8) powered

CURRENT CYCLING RESULTS

Test Condition: 500 Cycles, 45 minutes ON and 15 minutes OFF

- Test Current -----18.1 Amps
- Contact Resistances, Measured 40 minutes into the FIRST and LAST ON cycle
 - Initial
 - Min ----- 0.29mOhms
 - Max----- 0.34mOhms
 - Final
 - Min ----- 0.29mOhms
 - Max----- 0.34mOhms
- Temperature Change, Measured 40 minutes into the FIRST and LAST ON cycle
 - Initial Temperature Change -----31.2°C
 - Final Temperature Change -----30.8°C

TEST DATA

CONTACT RESISTANCE @ RATED CURRENT - DC Resistance (DCR)

The following data represents the Voltage drop and Contact Resistance at Rated Current for the 100% energized samples:

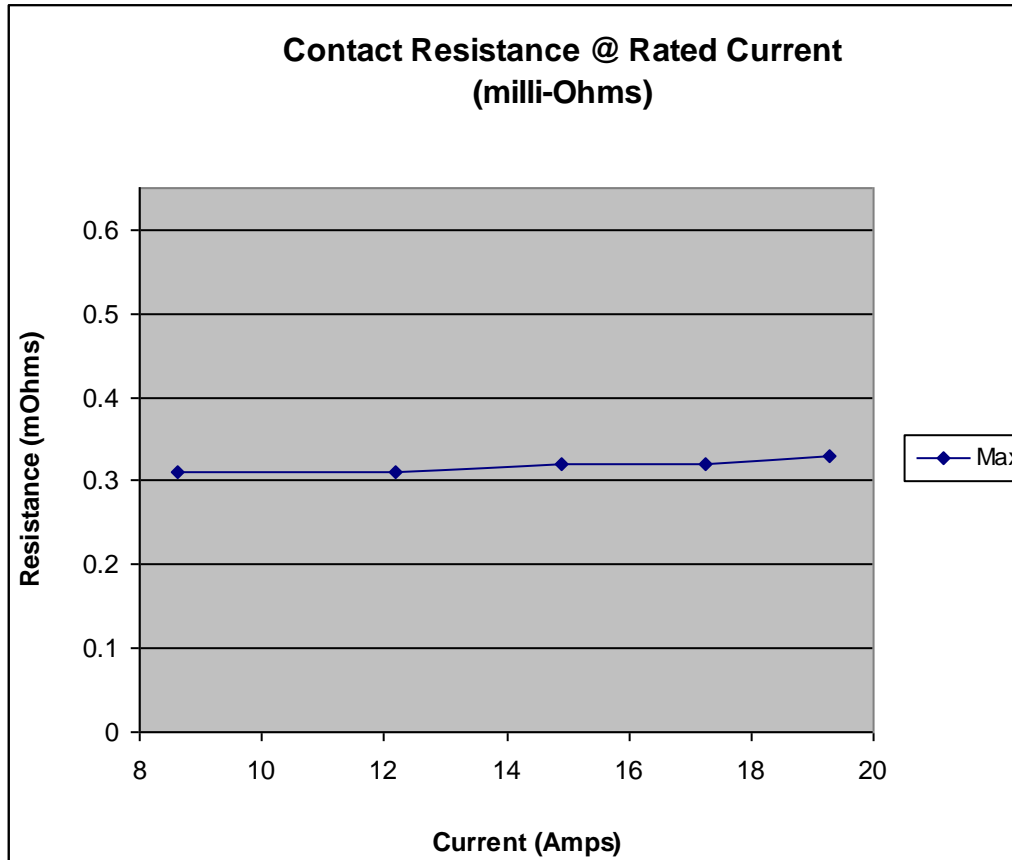

**CONTACT RESISTANCE DATA
ALL CONTACTS ENERGIZED
(mΩ)**

TEST CURRENT AMPS	8.62	12.19	14.91	17.24	19.27
Min	0.28	0.29	0.29	0.30	0.30
Max	0.31	0.31	0.32	0.32	0.33
Avg	0.29	0.29	0.30	0.31	0.31

TEST DATA

VOLTAGE DROP @ RATED CURRENT

The following data represents the Voltage drop at Rated Current for the 100% energized samples:

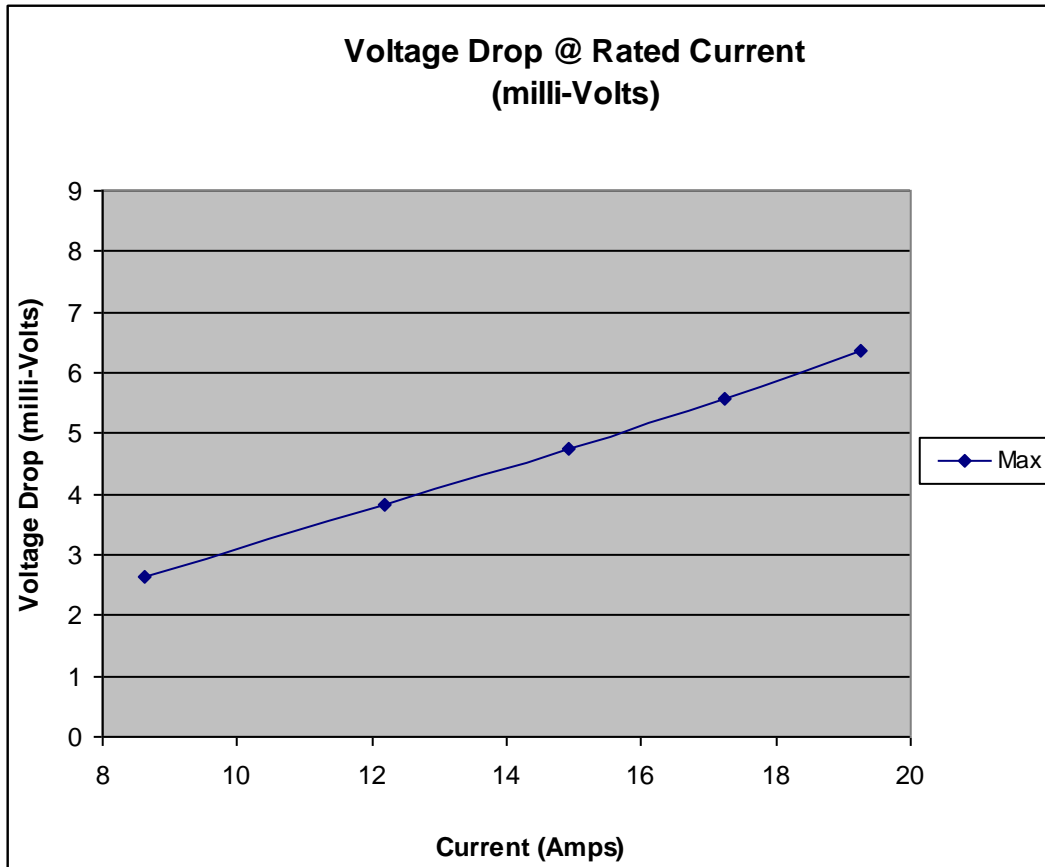

**VOLTAGE DROP DATA
ALL CONTACTS ENERGIZED
(mV)**

TEST CURRENT AMPS	8.62	12.19	14.91	17.24	19.27
Min	2.42	3.48	4.33	5.09	5.78
Max	2.64	3.81	4.74	5.58	6.35
Avg	2.52	3.63	4.53	5.33	6.07

CURRENT CARRYING CAPACITY DATA

236724

1 (1x1) Contacts in Series

Part Numbers: UPT-08-03.0-03-T-PV / UPS-08-04.0-03-T-PV

Current Rating per Contact (30 Deg. Rise, 20% Derated) = 24.8 Amps

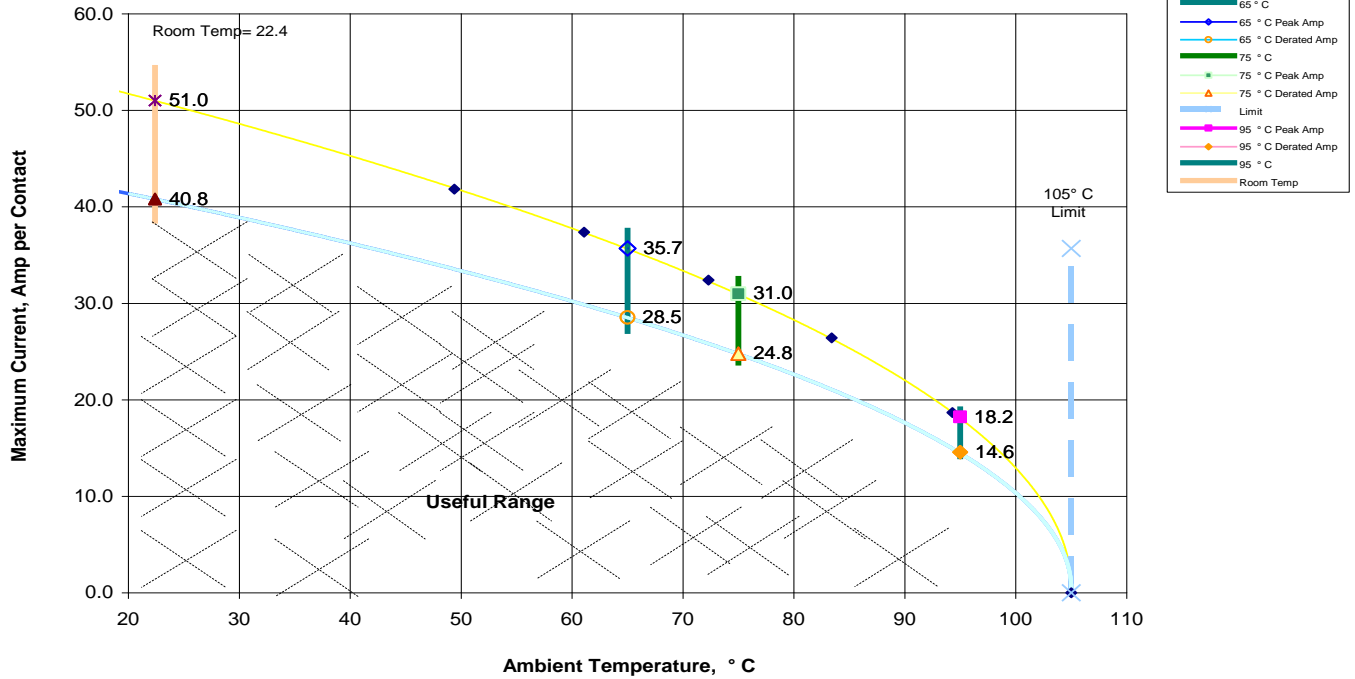

236724

1 (1x1) Contacts in Series

Part Numbers: UPT-08-03.0-03-T-PV / UPS-08-04.0-03-T-PV

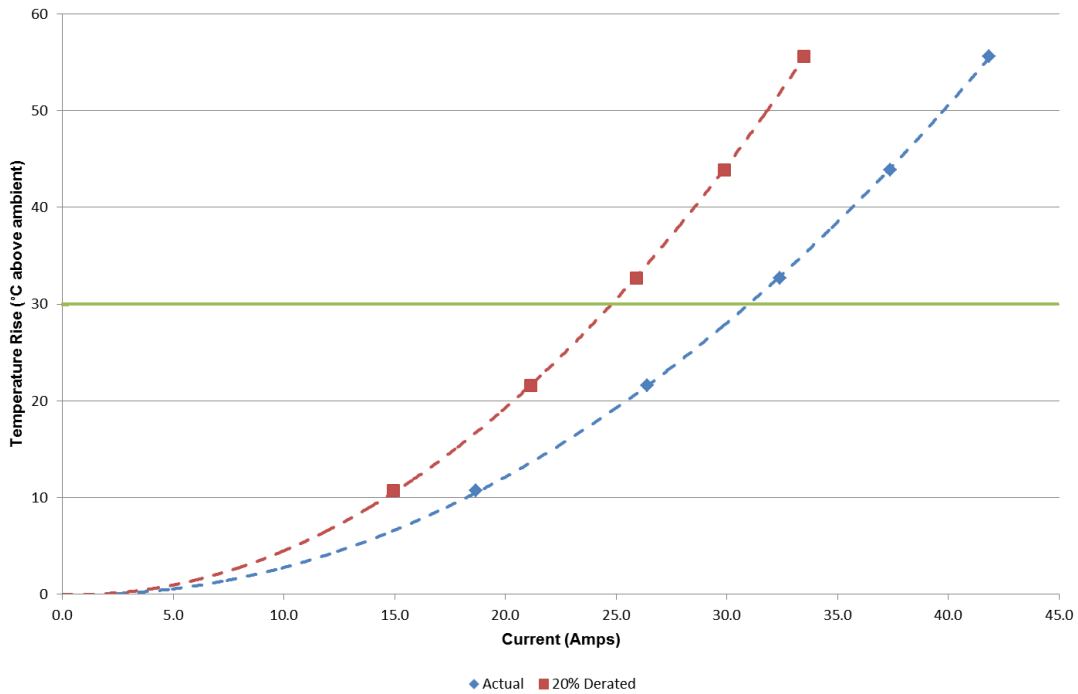



**POWER INTEGRITY TEST
REPORT**

236724

Revision 5

**TEMPERATURE RISE DATA
TWO CONTACT ENERGIZED
(Degrees Celsius above ambient)**

TEST CURRENT AMPS	18.67	26.41	32.40	37.38	41.82
Sample 1	11.0	22.3	33.6	45.3	57.3
Sample 2	10.6	21.6	32.7	43.9	55.8
Sample 3	10.6	21.0	31.7	42.5	53.8
Min	10.6	21	31.7	42.5	53.8
Max	11	22.3	33.6	45.3	57.3
Avg	10.73	21.63	32.67	43.9	55.63

Single Row
Configuration

✦ Indicates energized contacts

✦ Indicates thermocouple monitored, energized contacts

✦			
---	--	--	--

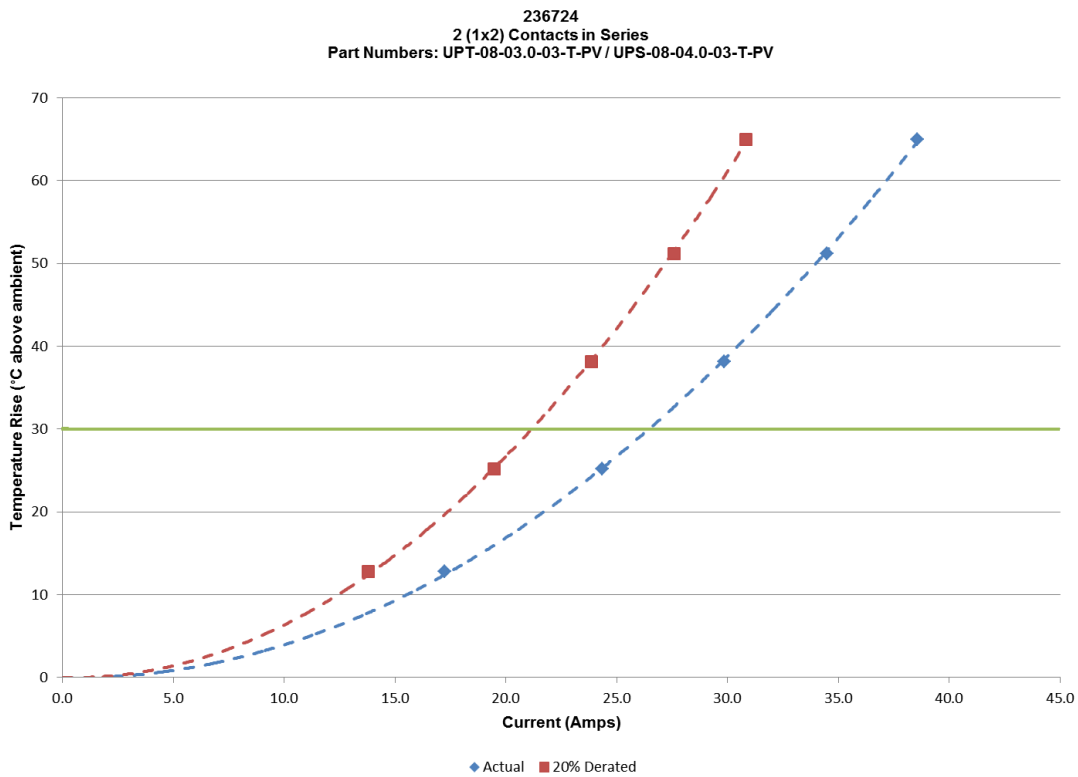
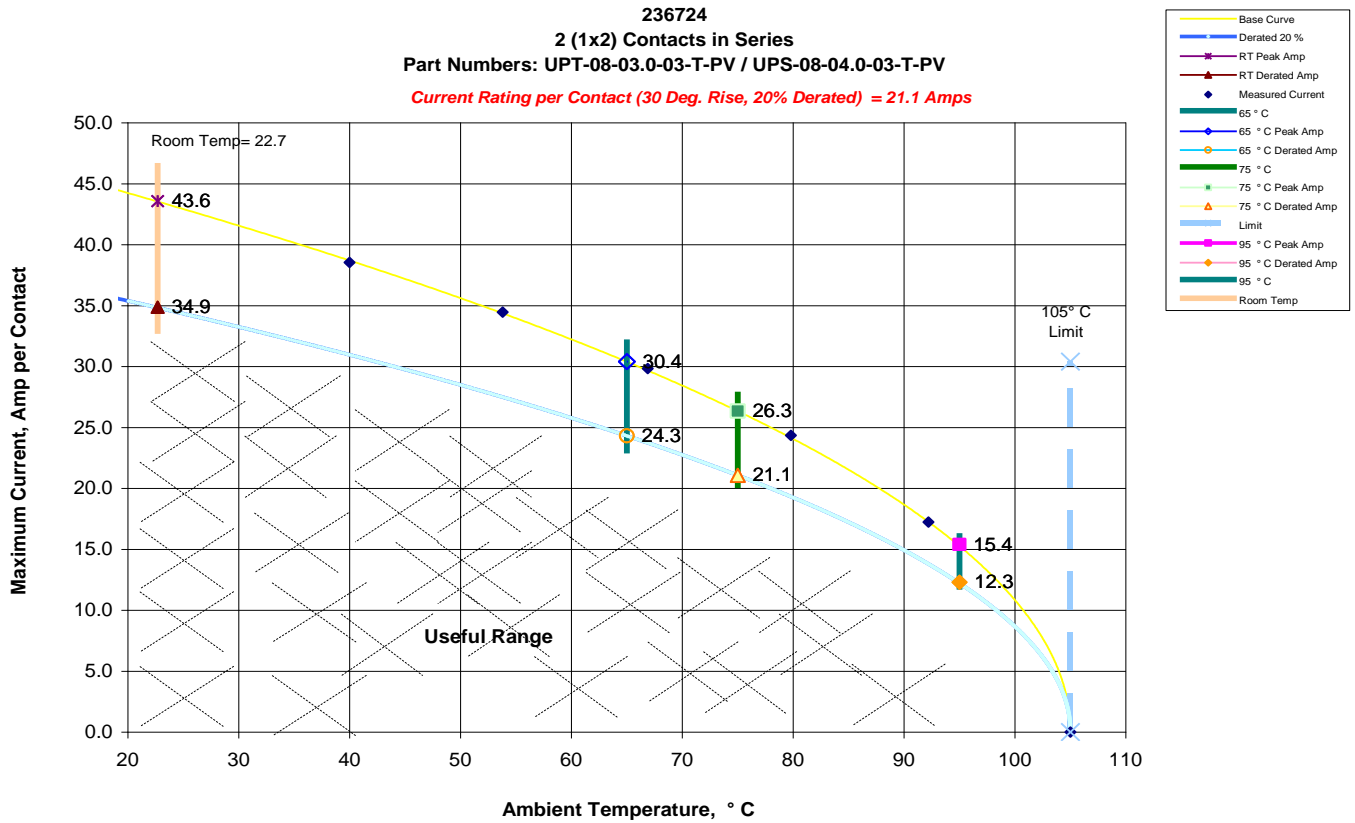



**POWER INTEGRITY TEST
REPORT**

236724

Revision 5

**TEMPERATURE RISE DATA
FOUR CONTACTS ENERGIZED
(Degrees Celsius above ambient)**

TEST CURRENT AMPS	17.24	24.35	29.84	34.47	38.55
Sample 4	13.4	26.3	39.9	53.7	68.3
Sample 5	12.5	24.5	37	49.6	62.9
Sample 6	12.5	24.9	37.5	50.4	63.9
Min	12.5	24.5	37	49.6	62.9
Max	13.4	26.3	39.9	53.7	68.3
Avg	12.8	25.23	38.13	51.23	65.03

✦ Indicates energized contacts

✦ Indicates thermocouple monitored, energized contacts

✦	✦		
---	---	--	--

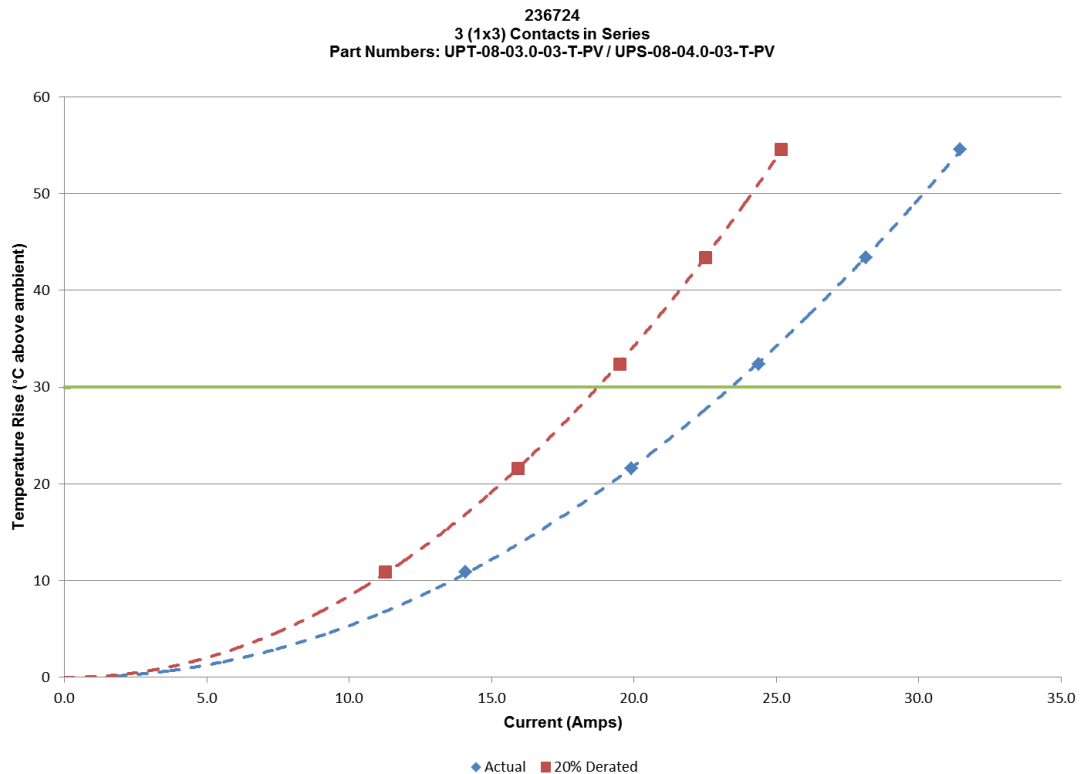
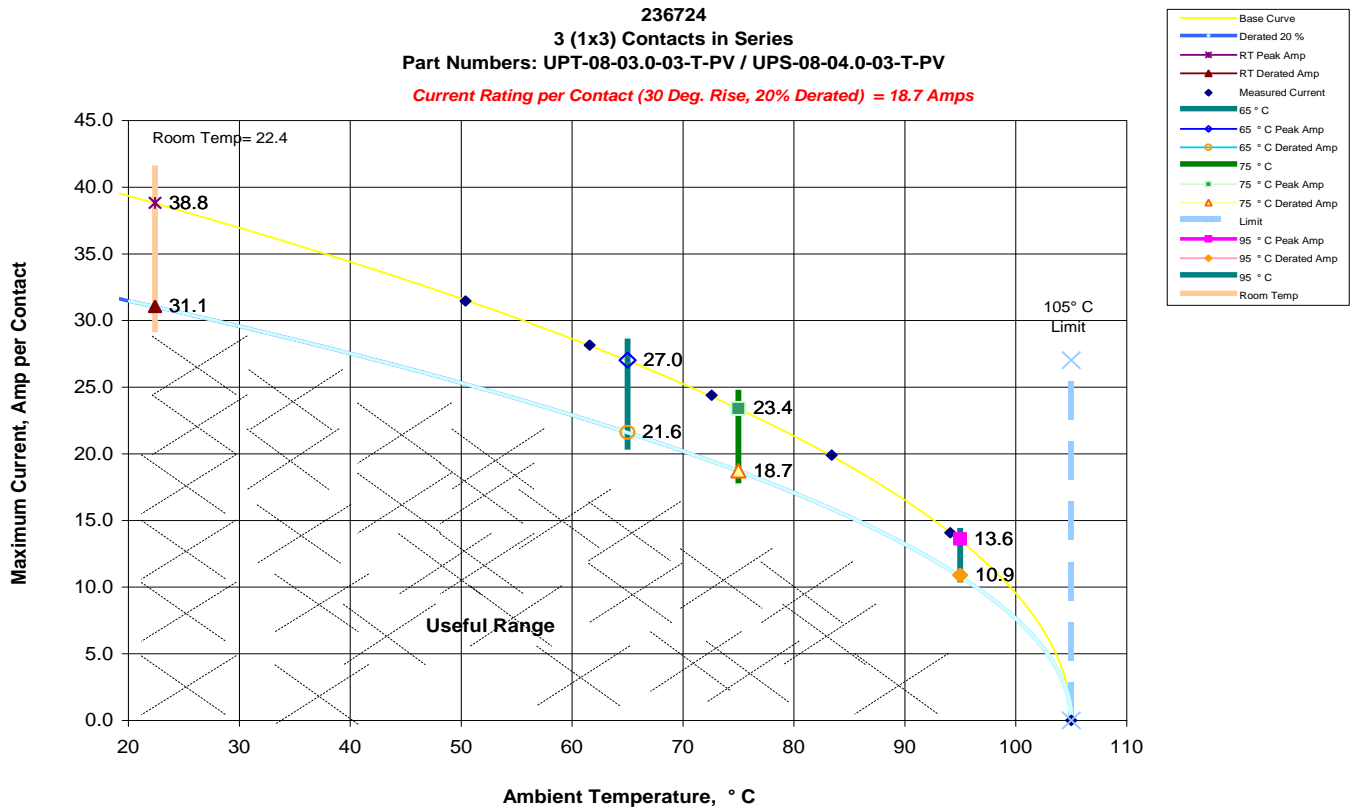



**POWER INTEGRITY TEST
REPORT**

236724

Revision 5

**TEMPERATURE RISE DATA
SIX CONTACTS ENERGIZED
(Degrees Celsius above ambient)**

TEST CURRENT AMPS	14.08	19.90	24.38	28.15	31.46
Sample 7	15.3	20.3	30.4	40.7	51.3
Sample 8	16.7	22.3	33.4	44.9	56.5
Sample 9	16.7	22.2	33.3	44.6	55.9
Min	15.3	20.3	30.4	40.7	51.3
Max	16.7	22.3	33.4	44.9	56.5
Avg	16.23	21.6	32.37	43.4	54.57

✦ Indicates energized contacts

✦ Indicates thermocouple monitored, energized contacts

✦	✦	✦	
---	---	---	--

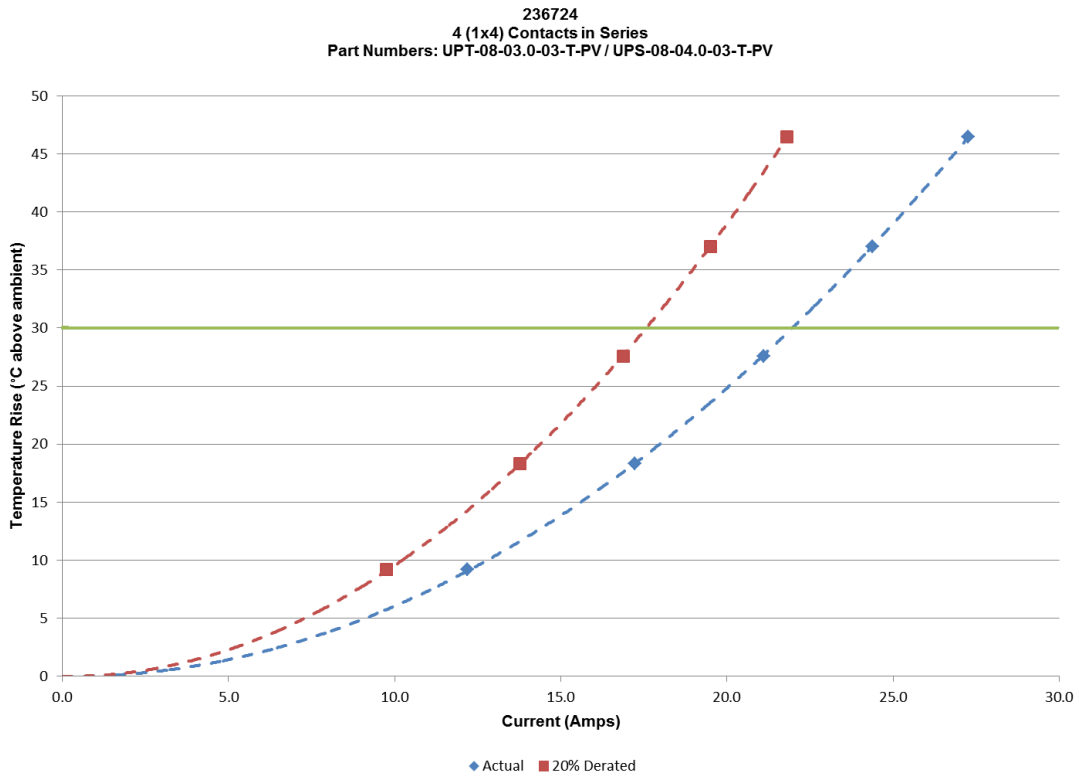
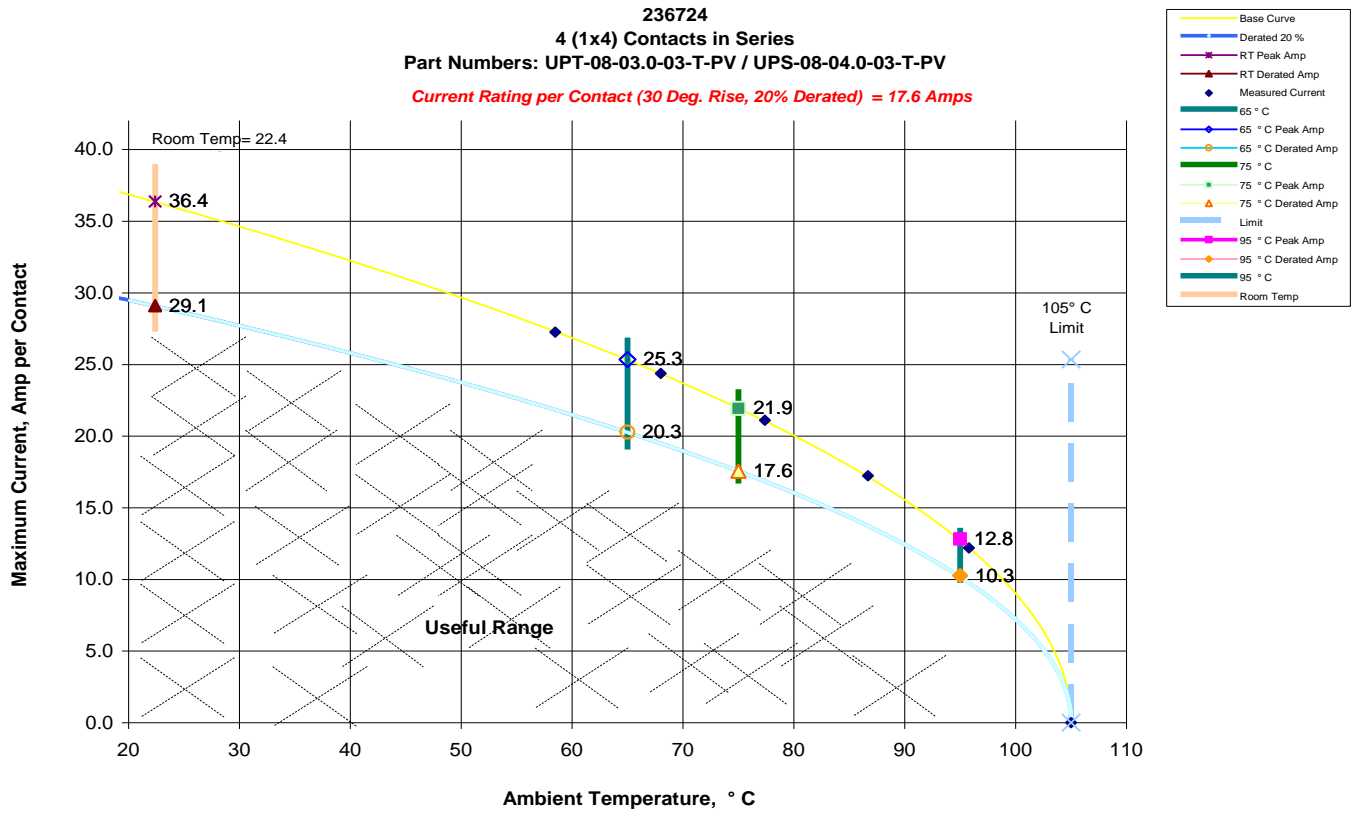

**TEMPERATURE RISE DATA
EIGHT CONTACTS ENERGIZED
(Degrees Celsius above ambient)**

TEST CURRENT AMPS	12.19	17.23	21.10	24.38	27.25
Sample 10	9.7	19.3	29.2	39.1	49.1
Sample 11	8.4	16.9	25.3	33.9	42.6
Sample 12	9.5	18.8	28.4	38	47.8
Min	8.4	16.9	25.3	33.9	42.6
Max	9.7	19.3	29.2	39.1	49.1
Avg	9.2	18.33	27.63	37	46.5

✦ Indicates energized contacts

✦ Indicates thermocouple monitored, energized contacts



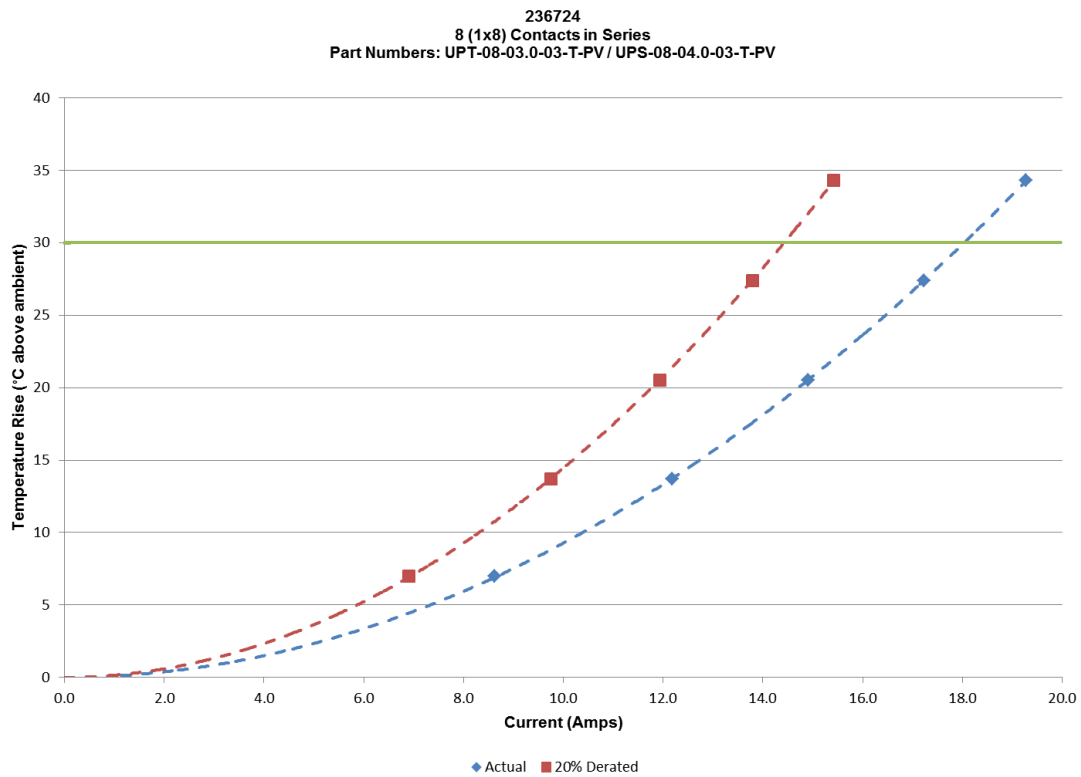
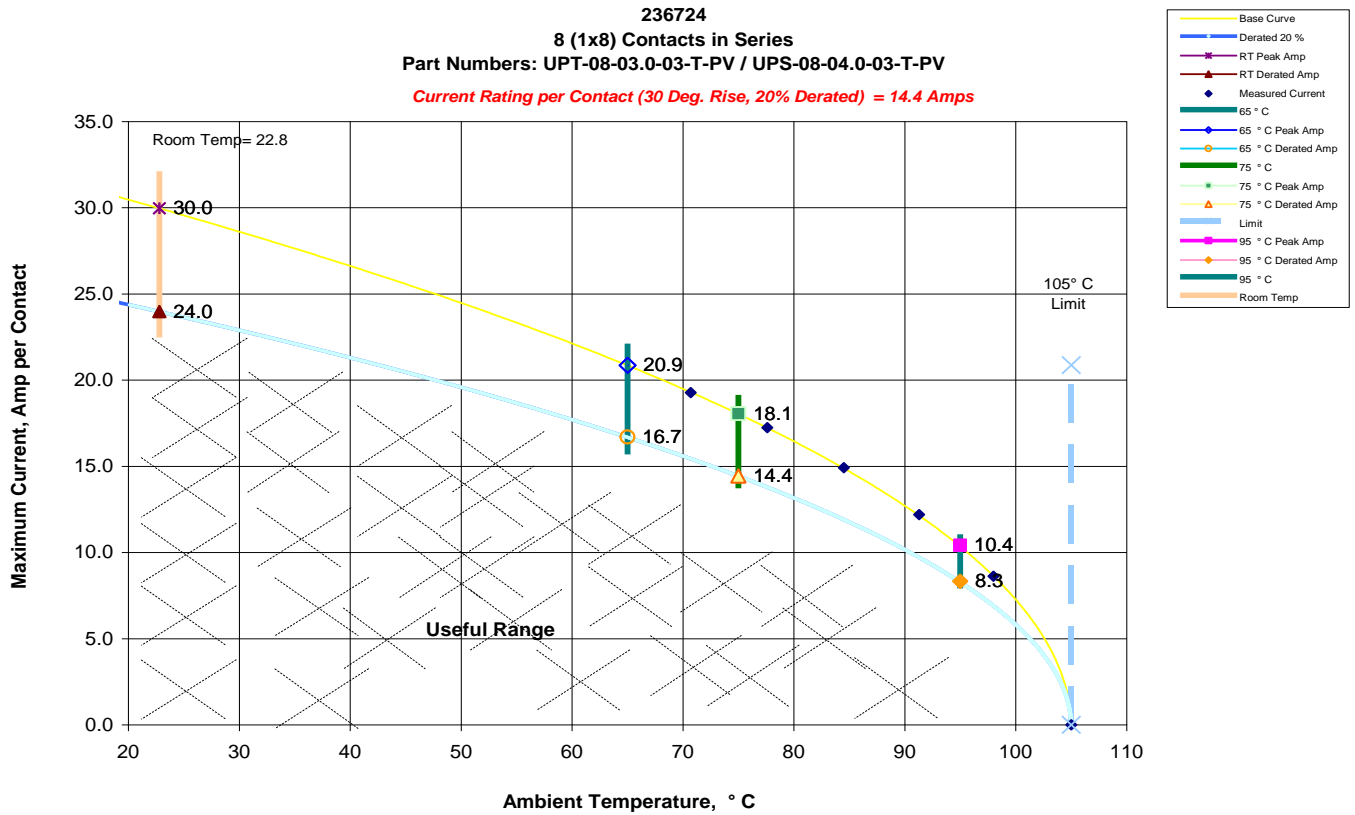

**TEMPERATURE RISE DATA
ALL CONTACTS ENERGIZED
(Degrees Celsius above ambient)**

TEST CURRENT AMPS	8.62	12.19	14.91	17.24	19.27
Sample 13	6.9	13.8	20.9	28	35.1
Sample 14	7	13.8	20.5	27.3	34
Sample 15	7	13.6	20.2	26.9	33.7
Min	6.9	13.6	20.2	26.9	33.7
Max	7	13.8	20.9	28	35.1
Avg	6.97	13.73	20.53	27.4	34.27

✦ Indicates energized contacts

✦ Indicates thermocouple monitored, energized contacts

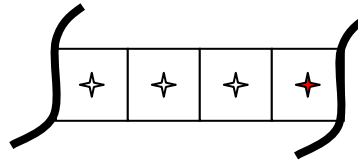

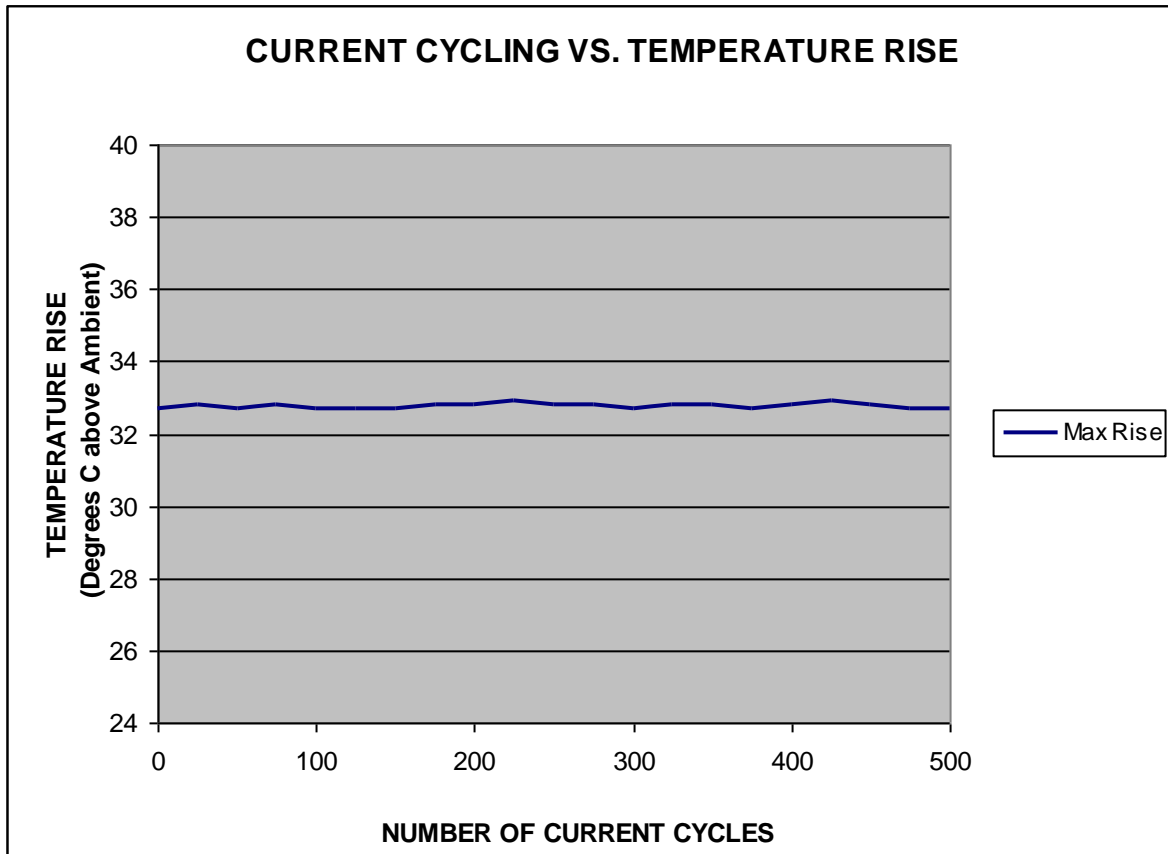

**TEMPERATURE RISE DATA
ALL CONTACTS ENERGIZED
(Degrees Celsius above ambient)**

	INITIAL	50 CYCLES	100 CYCLES	200 CYCLES	500 CYCLES
Min	29.3	29.4	29.3	29.4	28.9
Max	32.7	32.7	32.7	32.8	32.7
Avg	31.2	31	30.9	31	30.8

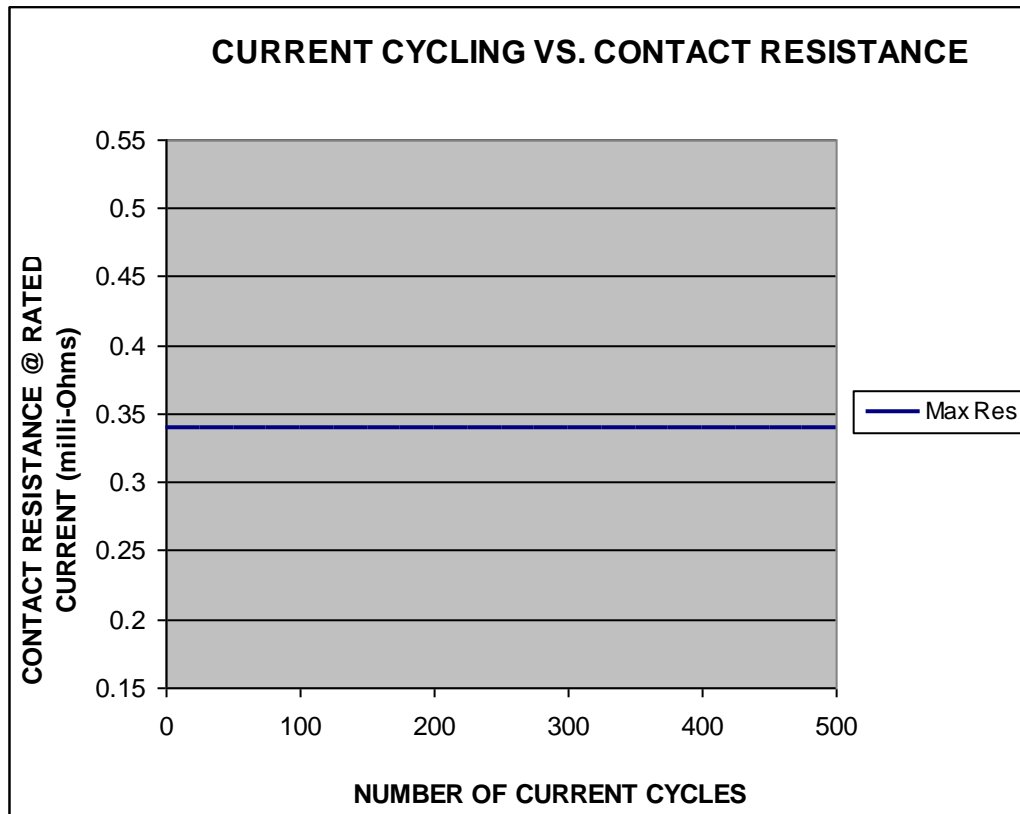

**CONTACT RESISTANCE DATA
ALL CONTACTS ENERGIZED
(mΩ)**

	INITIAL	50 CYCLES	100 CYCLES	200 CYCLES	500 CYCLES
Min	0.29	0.29	0.29	0.29	0.29
Max	0.34	0.34	0.34	0.34	0.34
Avg	0.32	0.32	0.32	0.32	0.32

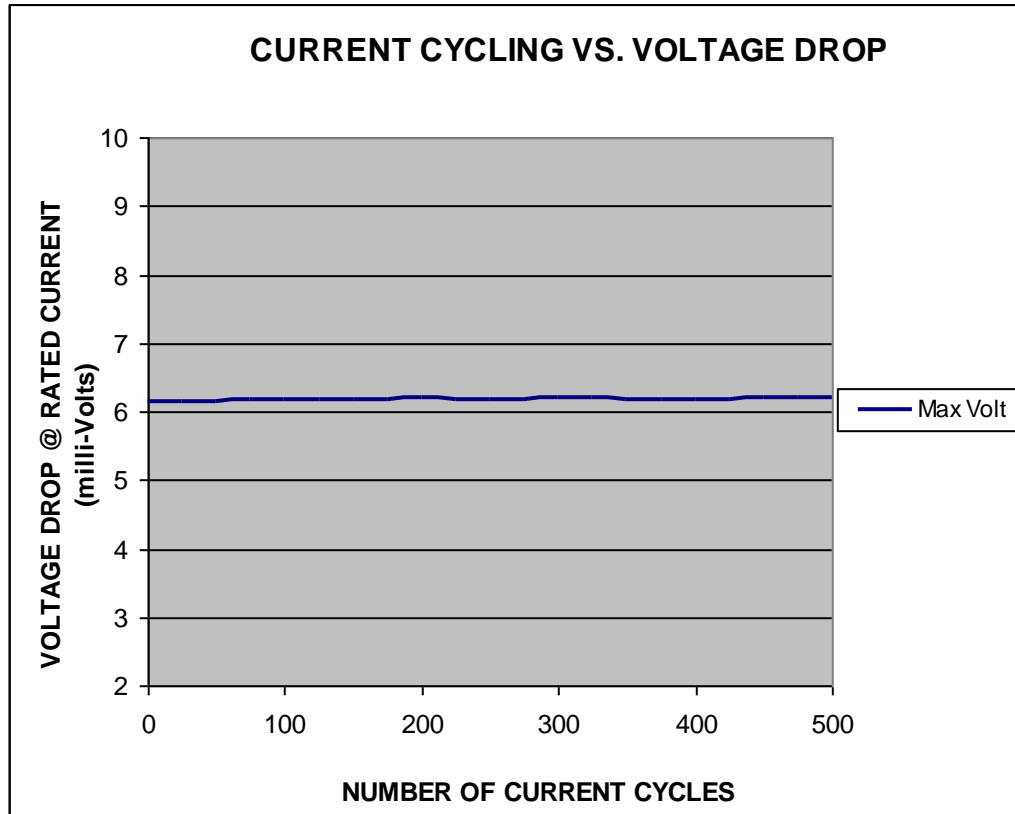

**VOLTAGE DROP DATA
ALL CONTACTS ENERGIZED
(MV)**

	INITIAL	50 CYCLES	100 CYCLES	200 CYCLES	500 CYCLES
Min	5.32	5.32	5.32	5.32	5.33
Max	6.16	6.15	6.17	6.19	6.19
Avg	5.81	5.81	5.81	5.81	5.83



EQUIPMENT AND CALIBRATION SCHEDULES

Equipment #: MO-04

Description: Multimeter /Data Acquisition System

Manufacturer: Keithley

Model: 2700

Serial #: 0798688

Accuracy: See Manual

... Last Cal: 04/30/2012, Next Cal: 04/30/2013

Equipment #: PS-07

Description: 20 V, 120 A DC Power Supply - AutoRanging SO/HPIB

Manufacturer: Hewlett Packard / Agilent

Model: AT-6031A

Serial #: 2721A00648

Accuracy: See Manual

... Last Cal: Reference Only, Next Cal: Reference Only

Equipment #: MO-09

Description: Model 2750 Multimeter/Switch System

Manufacturer: Keithley

Model: 2750

Serial #: WDC-874817

Accuracy: See Manual

... Last Cal: 10/20/2012, Next Cal: 10/20/2013

Equipment #: PS-09

Description: 60 V, 50 A DC Power Supply - AutoRanging SO

Manufacturer: Hewlett Packard / Agilent

Model: AT-6032A

Serial #: US38322853

Accuracy: See Manual

... Last Cal: Reference Only, Next Cal: Reference Only