



---

---

## High Speed Characterization Report

**QTE-020-04-L-D-A-TR**

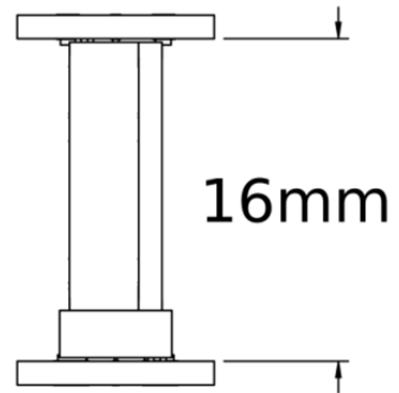

**Mates with**

**QSE-020-01-L-D-A-TR**



### **Description:**

**High Speed Ground Plane Header  
Board-to-Board, 0.8mm (.0315") Pitch, 16mm (.630") Stack Height**

**Series:** QTE/QSE**Description:** High Speed Ground Plane Header, 0.8mm (.0315") Pitch, 16mm (.630") Stack Height

## Table of Contents

Connector Overview .....	1
Frequency Domain Data Summary .....	2
Bandwidth Chart – Single-Ended & Differential Insertion Loss .....	3
Time Domain Data Summary .....	4
Characterization Details .....	7
Differential and Single-Ended Data .....	7
Connector Signal to Ground Ratio .....	7
Frequency Domain Data .....	9
Time Domain Data .....	9
Appendix A – Frequency Domain Response Graphs .....	11
Single-Ended Application – Insertion Loss .....	11
Single-Ended Application – Return Loss .....	11
Single-Ended Application – NEXT Configurations .....	12
Single-Ended Application – FEXT Configurations .....	12
Differential Application – Insertion Loss .....	13
Differential Application – Return Loss .....	13
Differential Application – NEXT Configurations .....	14
Differential Application – FEXT Configurations .....	14
Appendix B – Time Domain Response Graphs .....	15
Single-Ended Application – Input Pulse .....	15
Single-Ended Application – Impedance .....	16
Single-Ended Application – Propagation Delay .....	16
Single-Ended Application – NEXT, Worst Case Configuration .....	17
Single-Ended Application – FEXT, Worst Case Configuration .....	17
Single-Ended Application – NEXT, Best Case Configuration .....	18
Single-Ended Application – FEXT, Best Case Configuration .....	18
Single-Ended Application – NEXT, Across Row Configuration .....	19
Single-Ended Application – FEXT, Across Row Configuration .....	19
Differential Application – Input Pulse .....	20
Differential Application – Impedance .....	21
Differential Application – Propagation Delay .....	21
Differential Application – NEXT, Worst Case Configuration .....	22
Differential Application – FEXT, Worst Case Configuration .....	22
Differential Application – NEXT, Best Case Configuration .....	23
Differential Application – FEXT, Best Case Configuration .....	23
Differential Application – NEXT, Across Row Case Configuration .....	24
Differential Application – FEXT, Across Row Case Configuration .....	24
Appendix C – Product and Test System Descriptions .....	25

**Series:** QTE/QSE

**Description:** High Speed Ground Plane Header, 0.8mm (.0315") Pitch, 16mm (.630") Stack Height

Product Description .....	25
Test System Description .....	25
PCB-103741-TST-XX Test Fixtures.....	25
PCB-103741-TST-XX PCB Layout Panel .....	26
PCB Fixtures .....	26
Calibration Board .....	29
N5230C Measurement Setup .....	31
Test Instruments .....	31
Test Cables & Adapters .....	31
Appendix E - Frequency and Time Domain Measurements .....	32
Frequency (S-Parameter) Domain Procedures .....	32
Time Domain Procedures .....	32
Impedance (TDR).....	32
Propagation Delay (TDT) .....	33
Near-End Crosstalk (TDT) & Far End Crosstalk (TDT) .....	33
Appendix F – Glossary of Terms .....	34

**Series:** QTE/QSE

**Description:** High Speed Ground Plane Header, 0.8mm (.0315") Pitch, 16mm (.630") Stack Height

## Connector Overview

Samtec's QTE/QSE High Speed Ground Plane Header is designed for high-speed board-to-board applications where signal integrity is essential. The connectors have surface mount contacts as well as a surface-mount ground plane between the two rows of signals for improved electrical performance. QTE/QSE is a double row contacts system available with up to 200 I/Os in stack heights from 5mm (.197") through 30mm (1.180"). The data in this report is applicable only to a 16mm stack height.

## Connector System Speed Rating

QTE/QSE High Speed Ground Plane Connector, Board-to-Board, 0.8mm (.0315") Pitch, 16mm (0.630") Stack Height

<u>Signaling</u>	<u>Speed Rating</u>
Single-Ended:	<b>5.0 GHz/ 10Gbps</b>
Differential:	<b>8.5 GHz/ 17Gbps</b>

The Speed Rating is based on the -3 dB insertion loss point of the connector system. The -3 dB point can be used to estimate usable system bandwidth in a typical, two-level signaling environment. To calculate the Speed Rating, the measured -3 dB point is rounded-up to the nearest half-GHz level. The up rounding corrects for a portion of the test board's trace loss, since a short length of trace loss included in the loss data in this report. The resulting loss value is then doubled to determine the approximate maximum data rate in Gigabits per second (Gbps).

For example, a connector with a -3 dB point of 7.8 GHz would have a Speed Rating of 8 GHz/ 16 Gbps. A connector with a -3 dB point of 7.2 GHz would have a Speed Rating of 7.5 GHz/ 15 Gbps.

**Series:** QTE/QSE

**Description:** High Speed Ground Plane Header, 0.8mm (.0315") Pitch, 16mm (.630") Stack Height

**Frequency Domain Data Summary**

<b>Table 1 - Single-Ended Connector System Performance</b>		
<b>Test Parameter</b>	<b>Configuration</b>	
<b>Insertion Loss</b>	GSG	3dB @ 4.65 GHz
<b>Return Loss</b>	GSG	>10dB to 2.9 GHz
<b>Near-End Crosstalk</b>	GAQG	< -20dB to 0.363 GHz
	GAGQG	< -20dB to 0.459 GHz
	Xrow, GAG to GQG	< -20dB to 0.565 GHz
<b>Far-End Crosstalk</b>	GAQG	< -20dB to 4.813 GHz
	GAGQG	< -20dB to 4.638 GHz
	Xrow, GAG to GQG	< -20dB to 17.338 GHz

<b>Table 2 - Differential Connector System Performance</b>		
<b>Test Parameter</b>	<b>Configuration</b>	
<b>Insertion Loss</b>	GSSG	3dB @ 8.338 GHz
<b>Return Loss</b>	GSSG	>10dB to 3.325 GHz
<b>Near-End Crosstalk</b>	GAAQQG	< -20dB to 11.013 GHz
	GAAGQQG	< -20dB to 17.138 GHz
	Xrow, GAAG to GQQG	< -20dB to 20.000 GHz
<b>Far-End Crosstalk</b>	GAAQQG	< -20dB to 12.138 GHz
	GAAGQQG	< -20dB to 20.000 GHz
	Xrow, GAAG to GQQG	< -20dB to 20.000 GHz

**Series:** QTE/QSE

**Description:** High Speed Ground Plane Header, 0.8mm (.0315") Pitch, 16mm (.630") Stack Height

## Bandwidth Chart – Single-Ended & Differential Insertion Loss

QTE/QSE Ground Plane Header Series

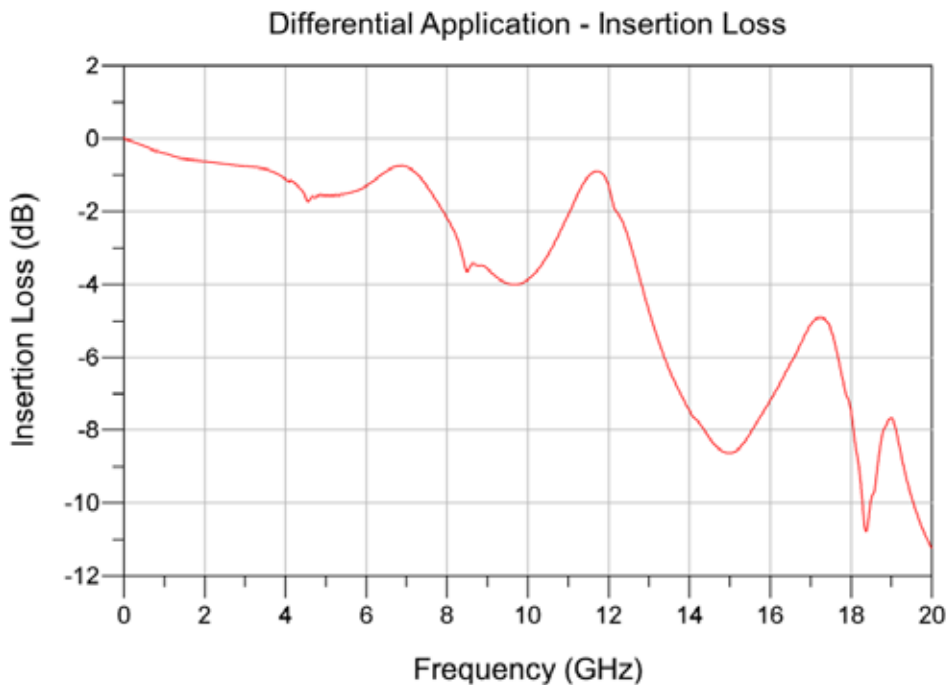
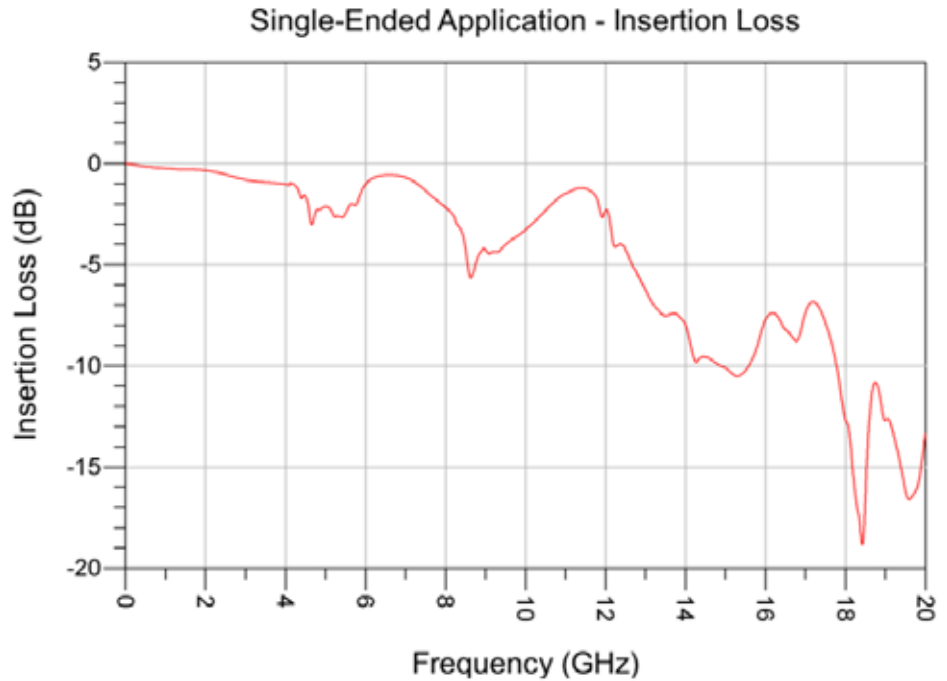

Series: QTE/QSE

Description: High Speed Ground Plane Header, 0.8mm (.0315") Pitch, 16mm (.630") Stack Height

## Time Domain Data Summary

Table 3 – Single-End Impedance ( $\Omega$ )					
Signal Risetime	30 ps	50 ps	100 ps	250 ps	500 ps
Maximum Impedance	71.2	64.4	60.2	55.8	52.7
Minimum Impedance	36.1	38.3	42.9	48	47.7

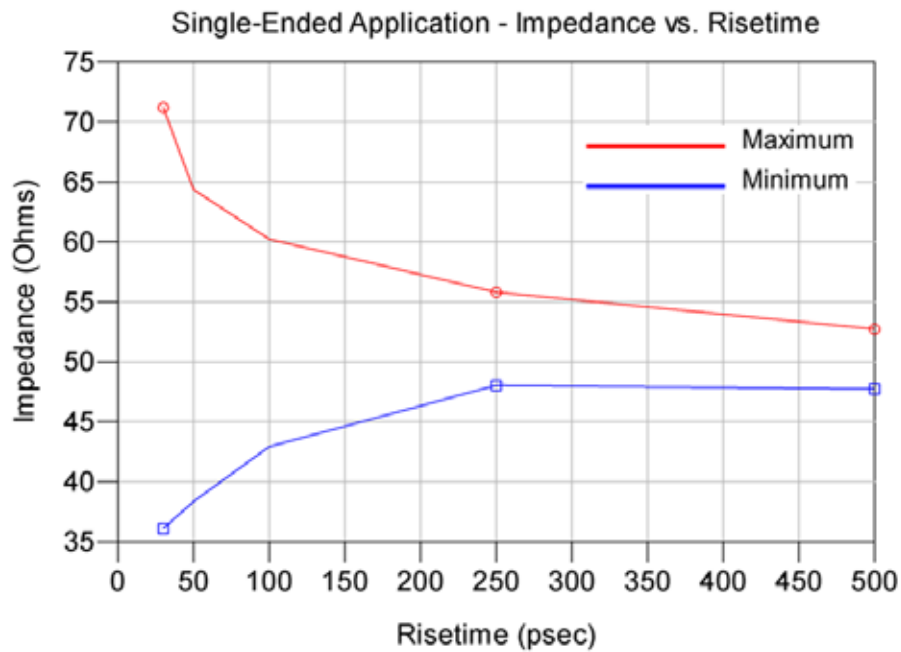

**Series:** QTE/QSE

**Description:** High Speed Ground Plane Header, 0.8mm (.0315") Pitch, 16mm (.630") Stack Height

Table 4 - Differential Impedance ( $\Omega$ )					
Signal Risetime	30 ps	50 ps	100 ps	250 ps	500 ps
Maximum Impedance	106.9	103.8	102.5	101.7	101
Minimum Impedance	52	56.4	66.2	78.8	87.2

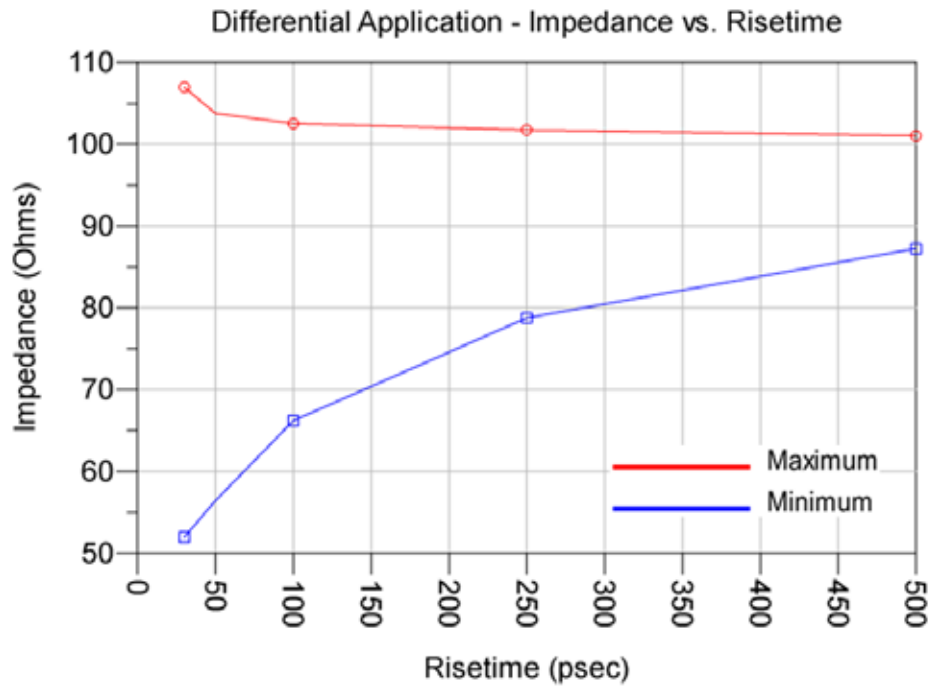

**Series:** QTE/QSE

**Description:** High Speed Ground Plane Header, 0.8mm (.0315") Pitch, 16mm (.630") Stack Height

Table 5 - Single-Ended Crosstalk (%)						
Input(tr)		30ps	50 ps	100 ps	250 ps	500 ps
NEXT	GAQG	21.0	19.5	18.3	13.6	8.3
	GAGQG	4.4	3.8	2.6	1.8	1.1
	Xrow	0.9	0.5	0.2	<0.1%	<0.1%
FEXT	GAQG	4.9	3.5	2.8	2.1	1.2
	GAGQG	3.4	2.7	1.7	0.7	0.4
	Xrow	0.6	0.4	0.1	<0.1%	<0.1%

Table 6 - Differential Crosstalk (%)						
Input(tr)		30ps	50 ps	100 ps	250 ps	500 ps
NEXT	GAAQQG	6.0	5.6	5.3	3.9	2.4
	GAAGQQG	0.7	0.5	0.4	0.3	0.2
	Xrow	0.1	<0.1%	<0.1%	<0.1%	<0.1%
FEXT	GAAQQG	2.2	1.6	0.9	0.7	0.4
	GAAGQQG	0.5	0.4	0.3	0.1	<0.1%
	Xrow	0.1	<0.1%	<0.1%	<0.1%	<0.1%

Table 7 - Propagation Delay (Mated Connector)	
Single-Ended	129 ps
Differential	121 ps

**Series:** QTE/QSE

**Description:** High Speed Ground Plane Header, 0.8mm (.0315") Pitch, 16mm (.630") Stack Height

### Characterization Details

This report presents data that characterizes the signal integrity response of a connector pair in a controlled printed circuit board (PCB) environment. All efforts are made to reveal typical best-case responses inherent to the system under test (SUT).

In this report, the SUT includes the connector pair and footprint effects on a typical multi-layer PCB. PCB effects (trace loss) are de-embedded from test data. Board related effects, such as pad-to-ground capacitance, are included in the data presented in this report.

Additionally, intermediate test signal connections can mask the connector's true performance. Such connection effects are minimized by using high performance test cables and adapters. Where appropriate, calibration and de-embedding routines are also used to reduce residual effects.

### Differential and Single-Ended Data

Most Samtec connectors can be used successfully in both differential and single-ended applications. However, electrical performance will differ depending on the signal drive type. In this report, data is presented for both differential and single-ended drive scenarios.

### Connector Signal to Ground Ratio

Samtec connectors are most often designed for generic applications and can be implemented using various signal and ground pin assignments. In high-speed systems, provisions must be made in the interconnect for signal return currents. Such paths are often referred to as "ground". In some connectors, a ground plane or blade, or an outer shield, is used as the signal return, while in others, connector pins are used as signal returns. Various combinations of signal pins, ground blades, and shields can also be utilized. Electrical performance can vary significantly depending upon the number and location of ground pins.

In general, the more pins dedicated to ground, the better electrical performance will be. However, dedicating pins to ground reduces signal density of a connector. Therefore, care must be taken when choosing signal/ground ratios in cost or density-sensitive applications.

**Series:** QTE/QSE

**Description:** High Speed Ground Plane Header, 0.8mm (.0315") Pitch, 16mm (.630") Stack Height

For this connector, the following array configurations are evaluated:

Single-Ended Impedance:

- GSG (ground-signal-ground)

Single-Ended Crosstalk:

- Electrical "worst case": GAQG (ground-active-quiet-ground)
- Electrical "best case": GAGQG (ground-active-ground-quiet-ground)
- Across row: "xrow case": GAG to GQG (from one row of terminals to the other

row)

Differential Impedance:

- GSSG (Ground-positive signal-negative signal-ground)

Differential Crosstalk:

- Electrical "worst case": GAAQQG (ground-active-active-quiet-quiet-ground)
- Electrical "best case": GAAGQQG (ground-active-active-ground-quiet-quiet-

ground)

- Across row: "xrow case": GAAG to GQQG (from one row of terminals to the other row)

Only one single-ended signal or differential pair was driven for crosstalk measurements.

Other configurations can be evaluated upon request. Please contact [sig@samtec.com](mailto:sig@samtec.com) for more information.

In a real system environment, active signals might be located at the outer edges of the signal contacts of concern, as opposed to the ground signals utilized in laboratory testing. For example, in a single-ended system, a pin-out of "SSSS", or four adjacent single ended signals might be encountered as opposed to the "GSG" and "GSSG" configurations tested in the laboratory. Electrical characteristics in such applications could vary slightly from laboratory results. However, in most applications, performance can safely be considered equivalent.

Signal Edge Speed (Rise Time):

In pulse signaling applications, the perceived performance of the interconnect can vary significantly depending on the edge rate or rise time of the exciting signal. For this report, the fastest rise time used was 30 ps. Generally, this should demonstrate worst-case performance.

In many systems, the signal edge rate will be significantly slower at the connector than at the driver launch point. To estimate interconnect performance at other edge rates, data is provided for several rise times between 30ps and 500ps.

For this report, measured rise times were at 10%-90% signal levels.

**Series:** QTE/QSE

**Description:** High Speed Ground Plane Header, 0.8mm (.0315") Pitch, 16mm (.630") Stack Height

### Frequency Domain Data

Frequency Domain parameters are helpful in evaluating the connector system's signal loss and crosstalk characteristics across a range of sinusoidal frequencies. In this report, parameters presented in the Frequency Domain are Insertion Loss, Return Loss, and Near-End and Far-End Crosstalk. Other parameters or formats, such as VSWR or S-Parameters, may be available upon request. Please contact our Signal Integrity Group at [sig@samtec.com](mailto:sig@samtec.com) for more information.

Frequency performance characteristics for the SUT are generated directly from network analyzer measurements.

### Time Domain Data

Time Domain parameters indicate Impedance mismatch versus length, signal propagation time, and crosstalk in a pulsed signal environment. The measured S-Parameters from the network analyzer are post-processed using Agilent Advanced Design System to obtain the time domain response. Time Domain procedure is provided in [Appendix E](#) of this report. Parameters or formats not included in this report may be available upon request. Please contact our Signal Integrity Group at [sig@samtec.com](mailto:sig@samtec.com) for more information.

In this report, propagation delay is defined as the signal propagation time through the connector and connector footprint. It includes 10 mils of PCB trace on the QTE connector side and 10 mils of PCB trace on the QSE connector side. Delay is measured at 30 picoseconds signal rise-time. Delay is calculated as the difference in time measured between the 50% amplitude levels of the input and output pulses.

Crosstalk or coupled noise data is provided for various signal configurations. All measurements are single disturber. Crosstalk is calculated as a ratio of the input line voltage to the coupled line voltage. The input line is sometimes described as the active or drive line. The coupled line is sometimes described as the quiet or victim line. Crosstalk ratio is tabulated in this report as a percentage. Measurements are made at both the near-end and far-end of the SUT.

Data for other configurations may be available. Please contact our Signal Integrity Group at [sig@samtec.com](mailto:sig@samtec.com) for further information.

As a rule of thumb, 10% crosstalk levels are often used as a general first pass limit for determining acceptable interconnect performance. However, modern system crosstalk tolerance can vary greatly. For advice on connector suitability for specific applications, please contact our Signal Integrity Group at [sig@samtec.com](mailto:sig@samtec.com).



**Series:** QTE/QSE

**Description:** High Speed Ground Plane Header, 0.8mm (.0315") Pitch, 16mm (.630") Stack Height

Additional information concerning test conditions and procedures is located in the appendices of this report. Further information may be obtained by contacting our Signal Integrity Group at [sig@samtec.com](mailto:sig@samtec.com).

Series: QTE/QSE

Description: High Speed Ground Plane Header, 0.8mm (.0315") Pitch, 16mm (.630") Stack Height

## Appendix A – Frequency Domain Response Graphs

### Single-Ended Application – Insertion Loss

Single-Ended Application - Insertion Loss

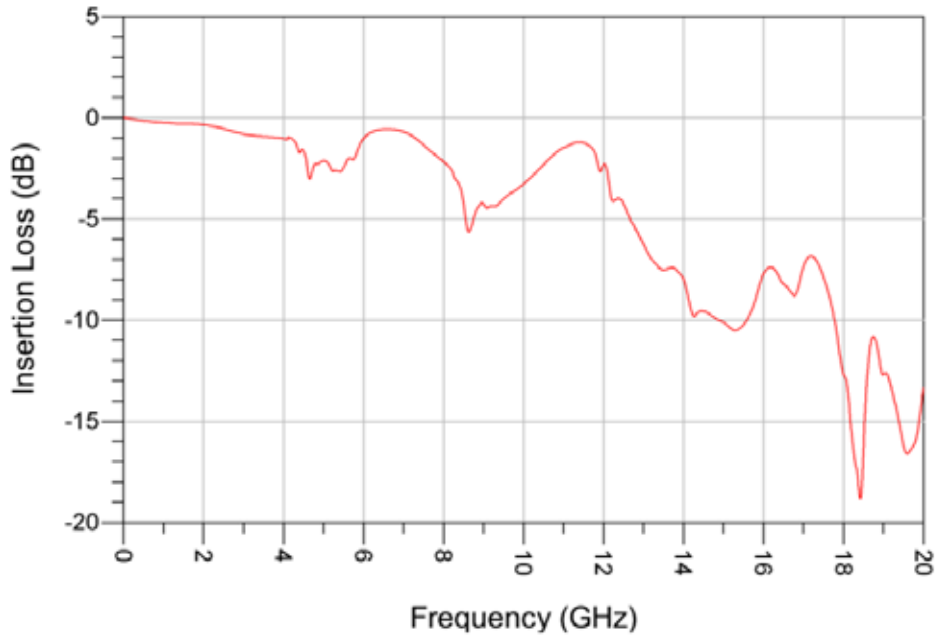

### Single-Ended Application – Return Loss

Single-Ended Application - Return Loss

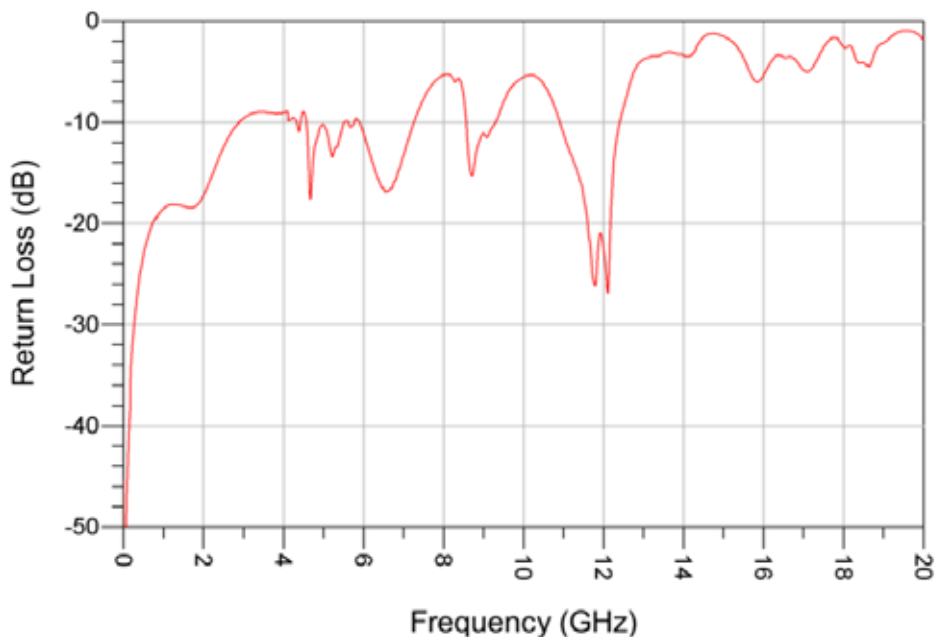

Series: QTE/QSE

Description: High Speed Ground Plane Header, 0.8mm (.0315") Pitch, 16mm (.630") Stack Height

## Single-Ended Application – NEXT Configurations

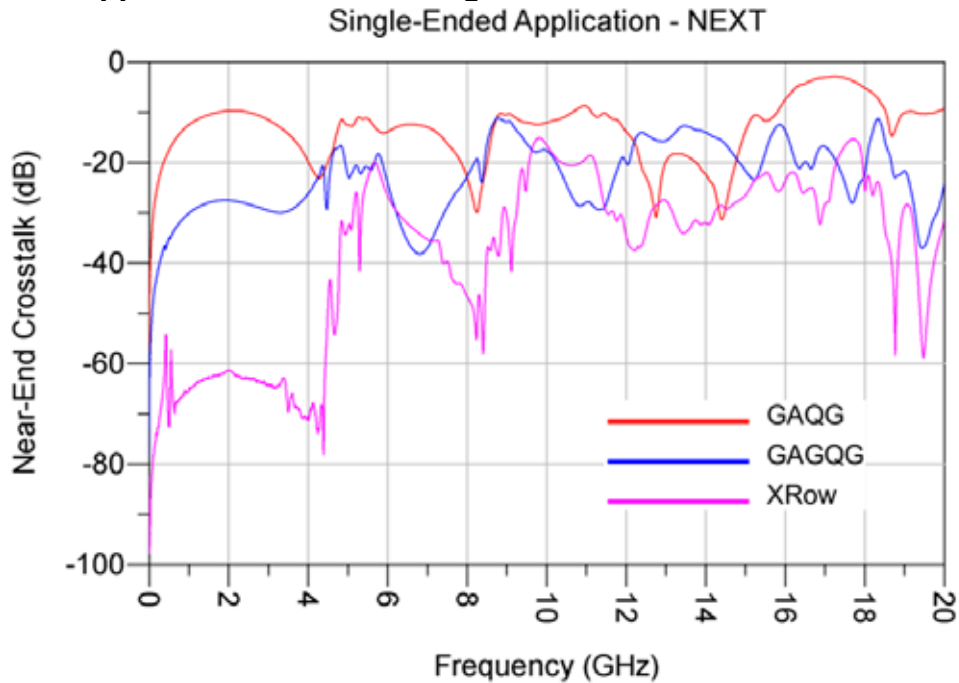

## Single-Ended Application – FEXT Configurations

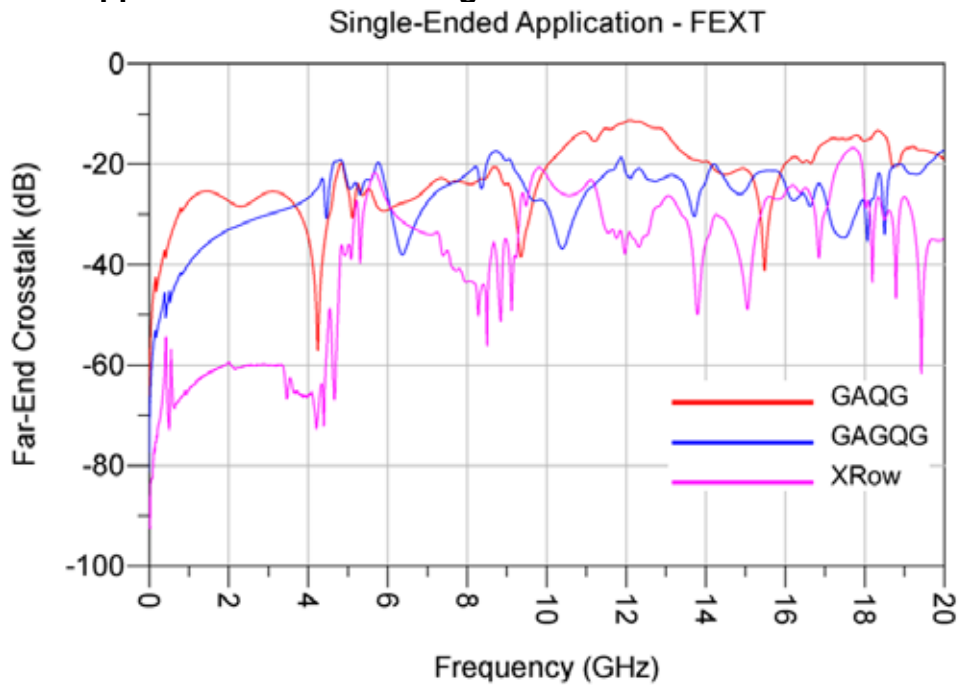

**Series:** QTE/QSE

**Description:** High Speed Ground Plane Header, 0.8mm (.0315") Pitch, 16mm (.630") Stack Height

## Differential Application – Insertion Loss

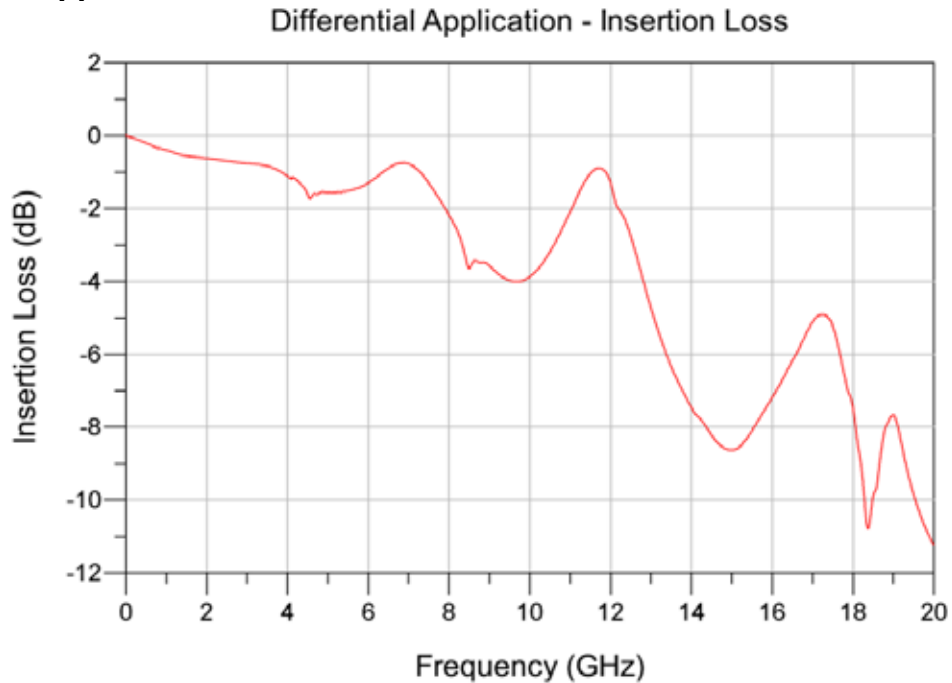

## Differential Application – Return Loss

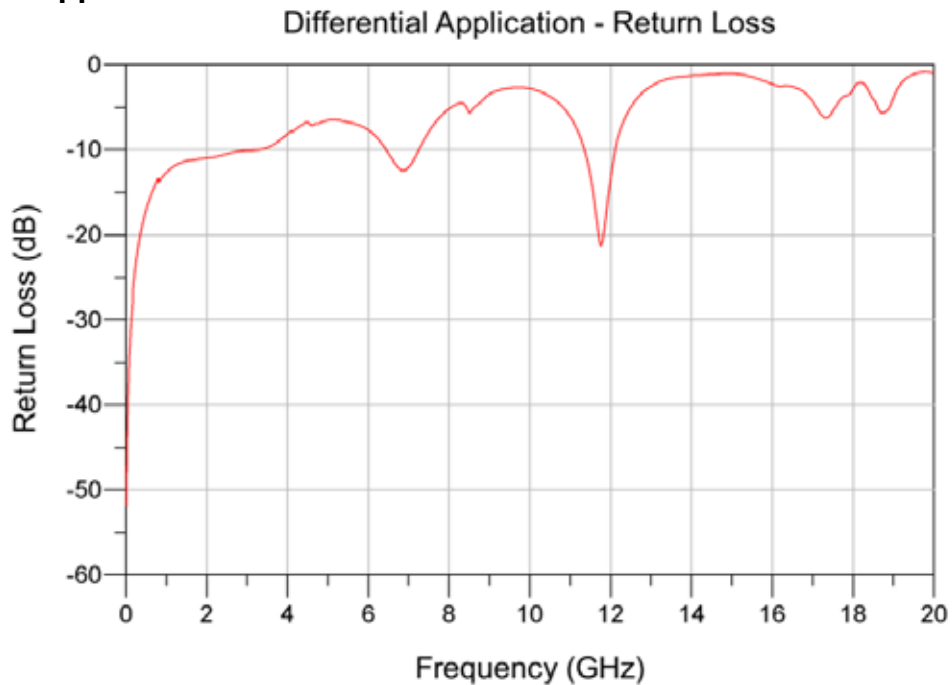

**Series:** QTE/QSE

**Description:** High Speed Ground Plane Header, 0.8mm (.0315") Pitch, 16mm (.630") Stack Height

## Differential Application – NEXT Configurations

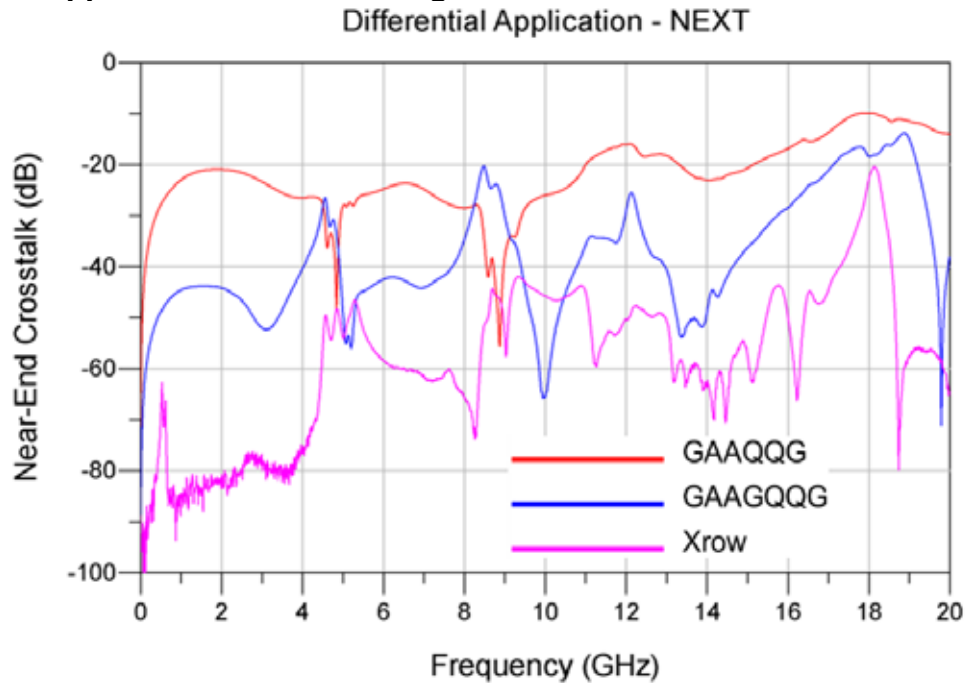

## Differential Application – FEXT Configurations

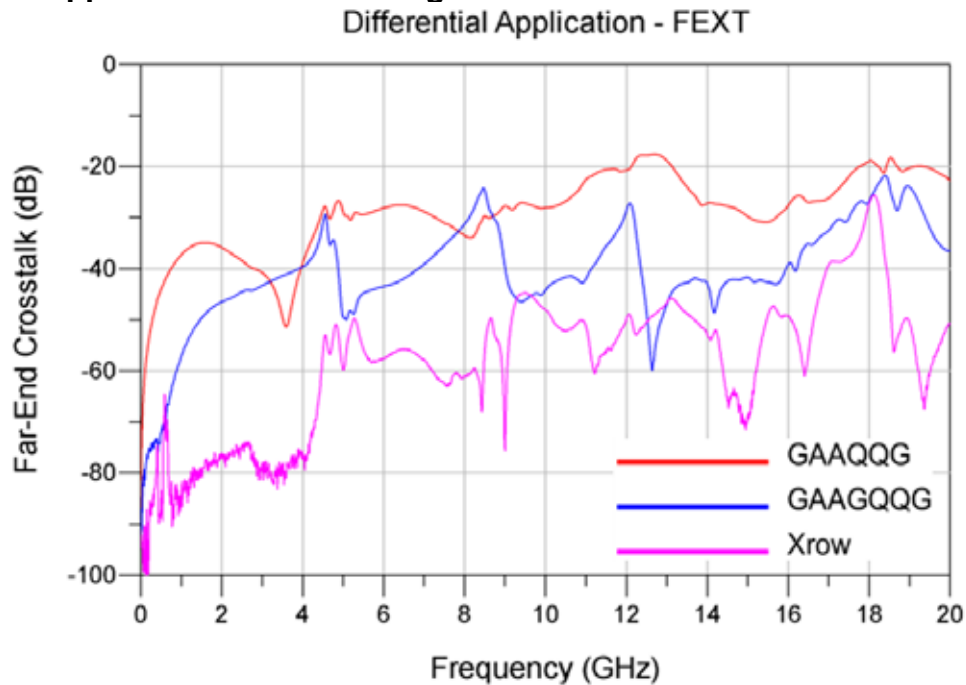

Series: QTE/QSE

Description: High Speed Ground Plane Header, 0.8mm (.0315") Pitch, 16mm (.630") Stack Height

## Appendix B – Time Domain Response Graphs

### Single-Ended Application – Input Pulse

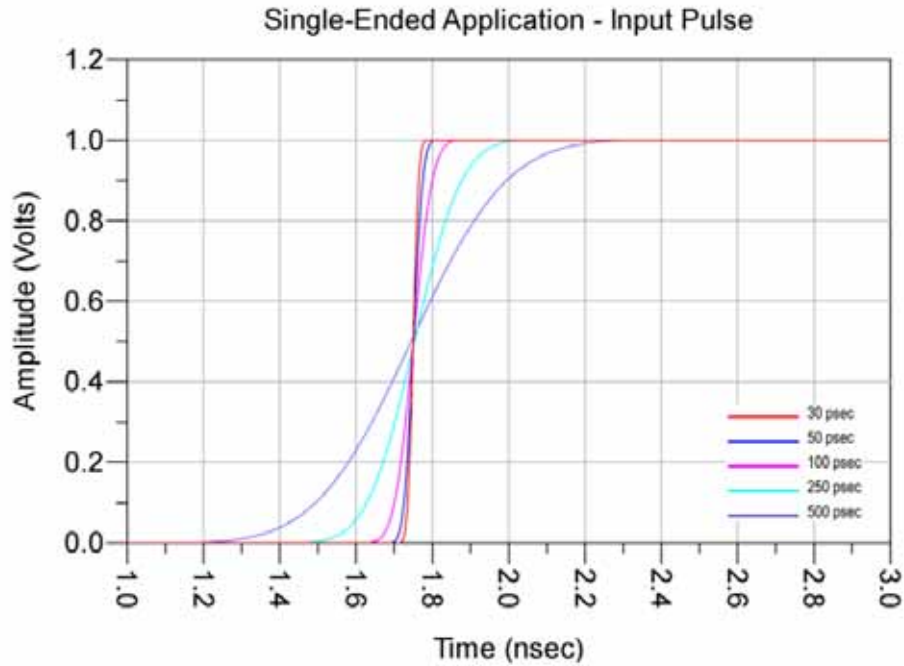

Series: QTE/QSE

Description: High Speed Ground Plane Header, 0.8mm (.0315") Pitch, 16mm (.630") Stack Height

### Single-Ended Application – Impedance

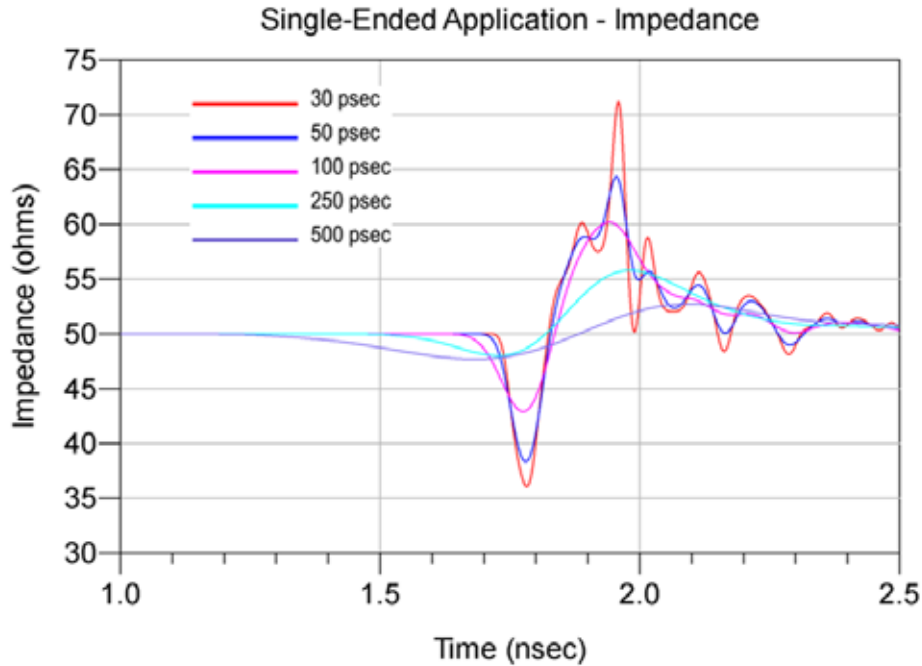

### Single-Ended Application – Propagation Delay

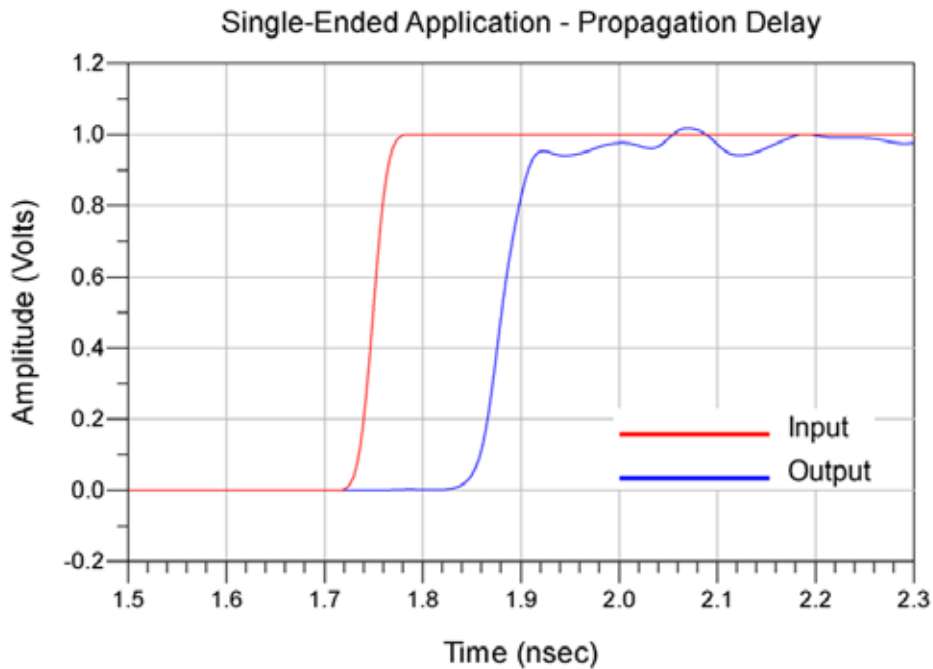

Series: QTE/QSE

Description: High Speed Ground Plane Header, 0.8mm (.0315") Pitch, 16mm (.630") Stack Height

## Single-Ended Application – NEXT, Worst Case Configuration

Single-Ended Application - NEXT

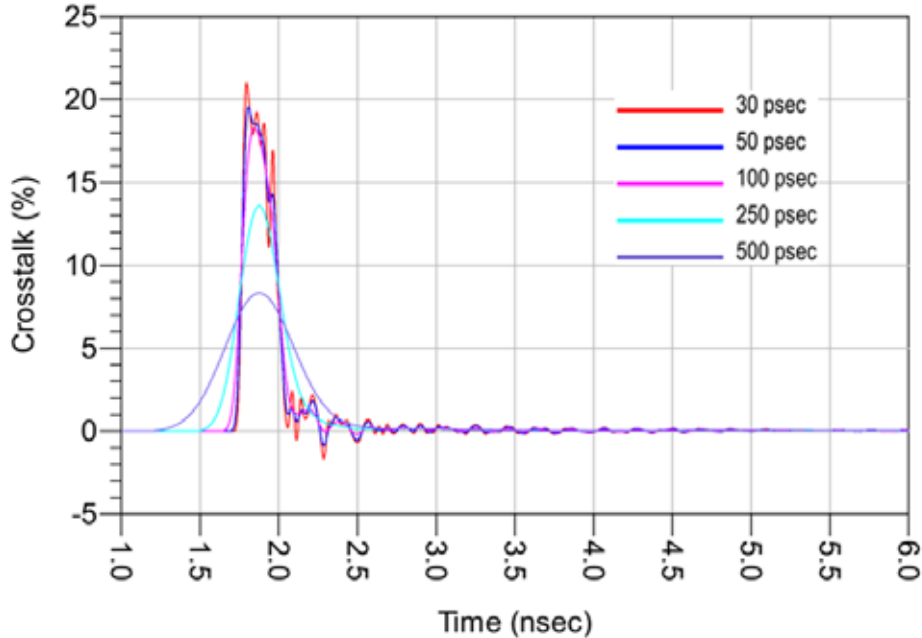

## Single-Ended Application – FEXT, Worst Case Configuration

Single-Ended Application - FEXT

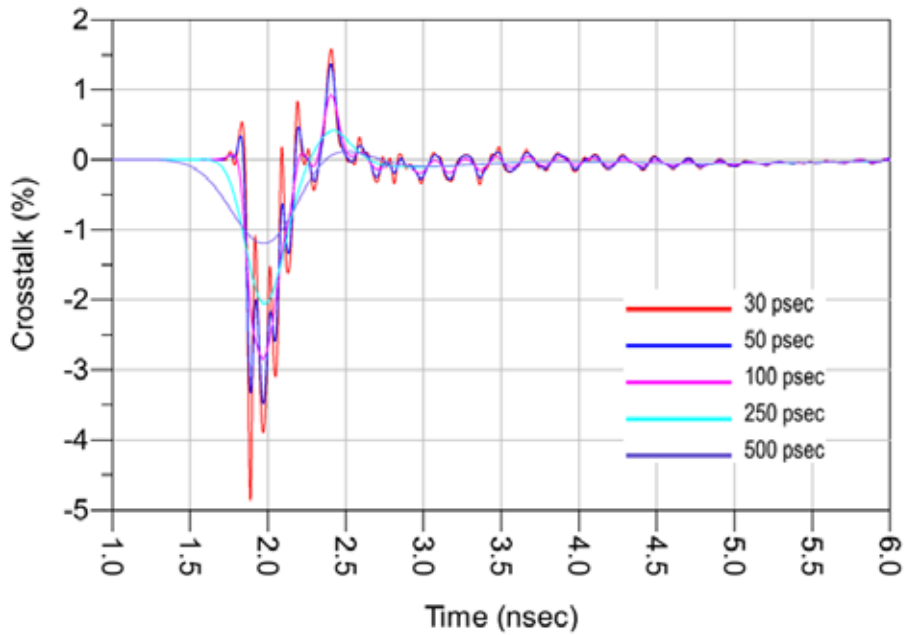

Series: QTE/QSE

Description: High Speed Ground Plane Header, 0.8mm (.0315") Pitch, 16mm (.630") Stack Height

## Single-Ended Application – NEXT, Best Case Configuration

Single-Ended Application - NEXT

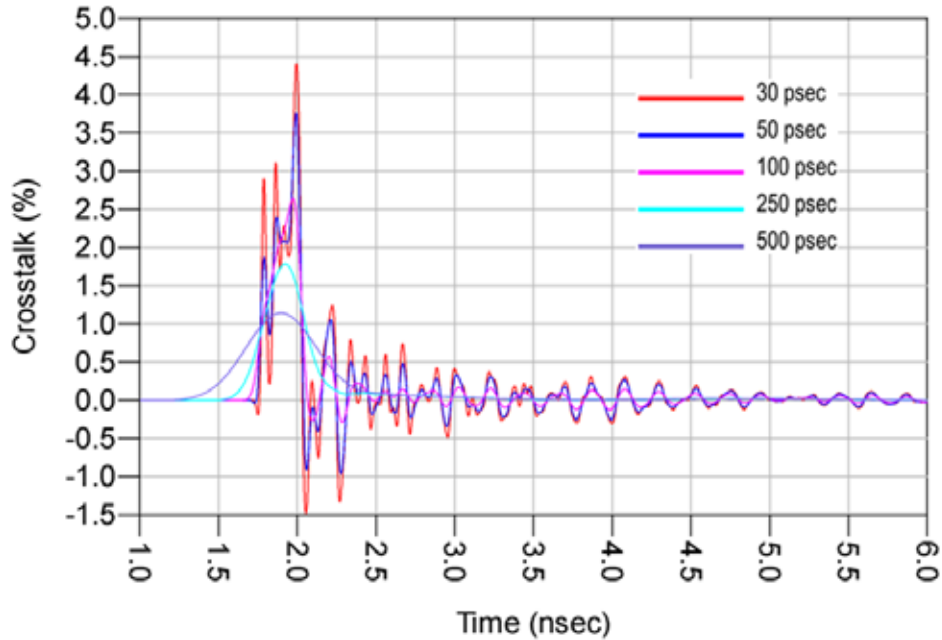

## Single-Ended Application – FEXT, Best Case Configuration

Single-Ended Application - FEXT

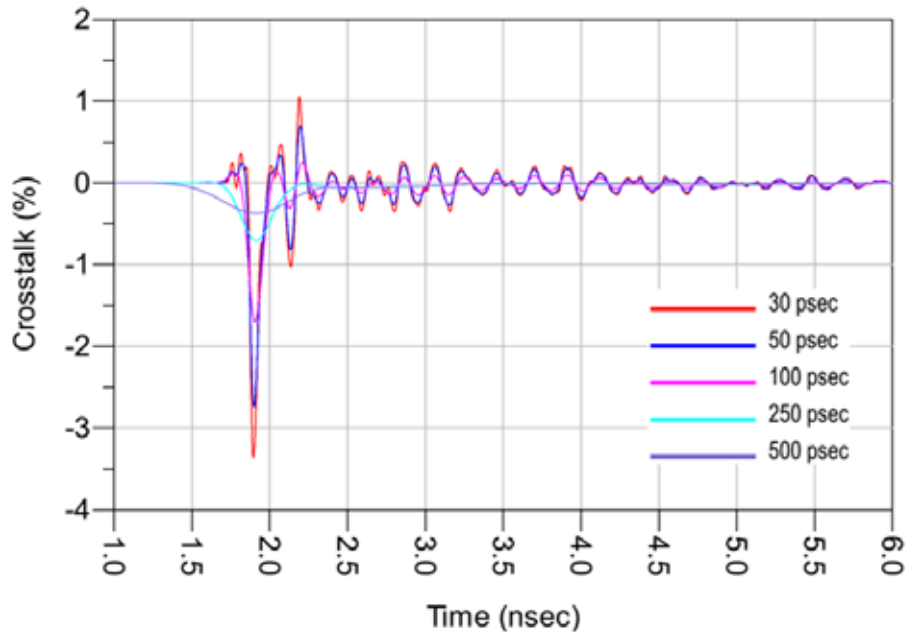

Series: QTE/QSE

Description: High Speed Ground Plane Header, 0.8mm (.0315") Pitch, 16mm (.630") Stack Height

## Single-Ended Application – NEXT, Across Row Configuration

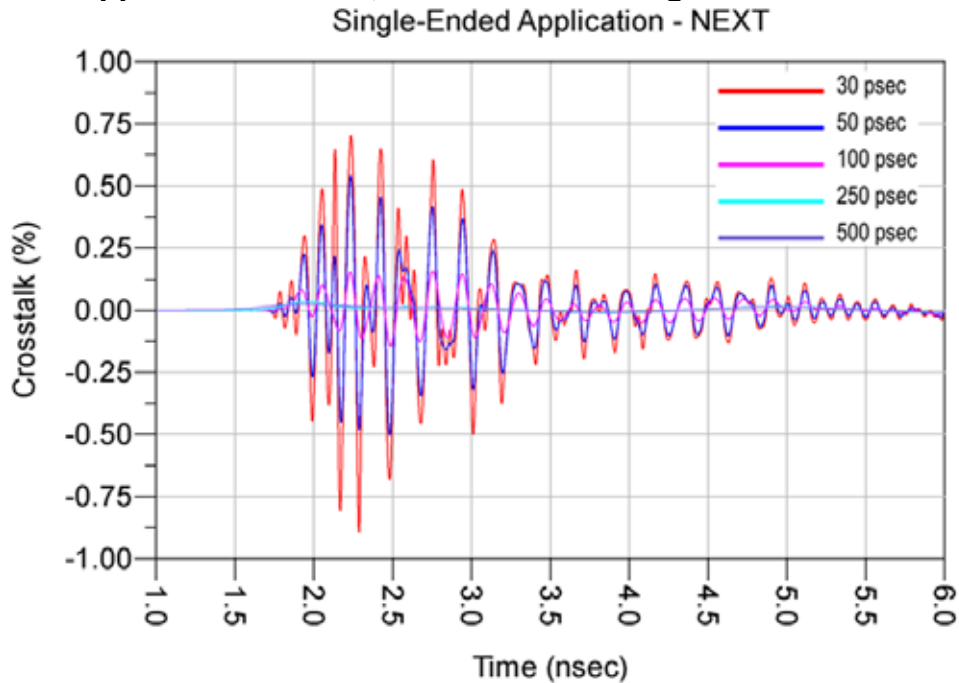

## Single-Ended Application – FEXT, Across Row Configuration

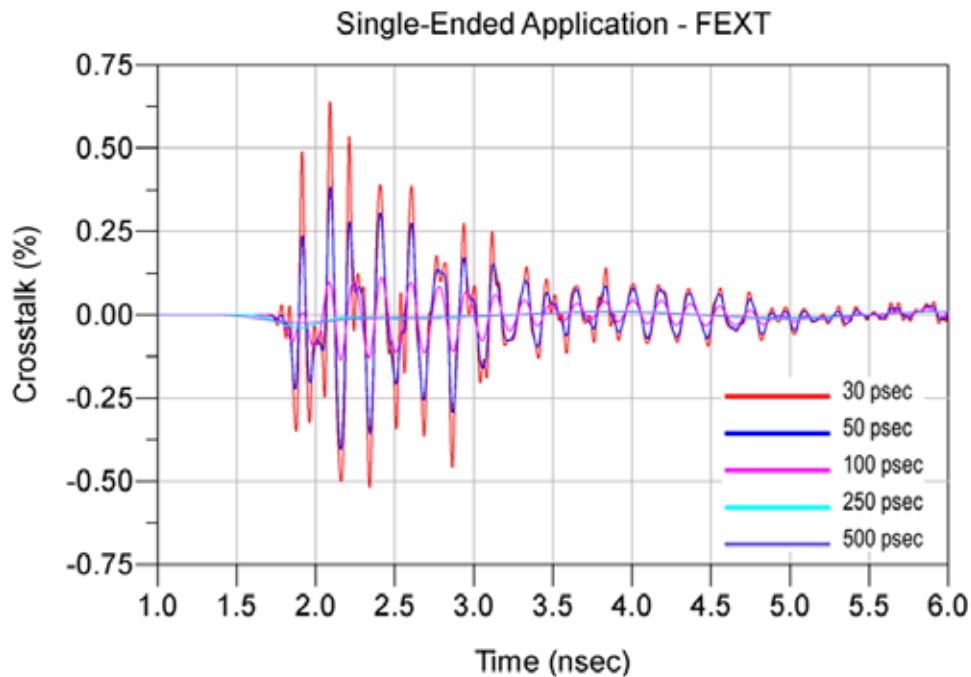

**Series:** QTE/QSE

**Description:** High Speed Ground Plane Header, 0.8mm (.0315") Pitch, 16mm (.630") Stack Height

## Differential Application – Input Pulse

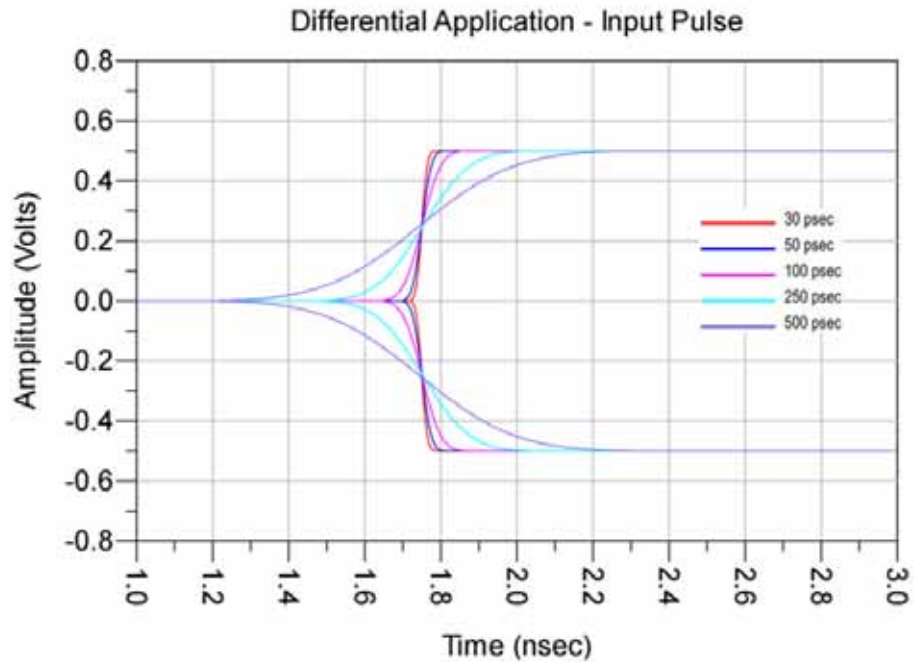

Series: QTE/QSE

Description: High Speed Ground Plane Header, 0.8mm (.0315") Pitch, 16mm (.630") Stack Height

### Differential Application – Impedance

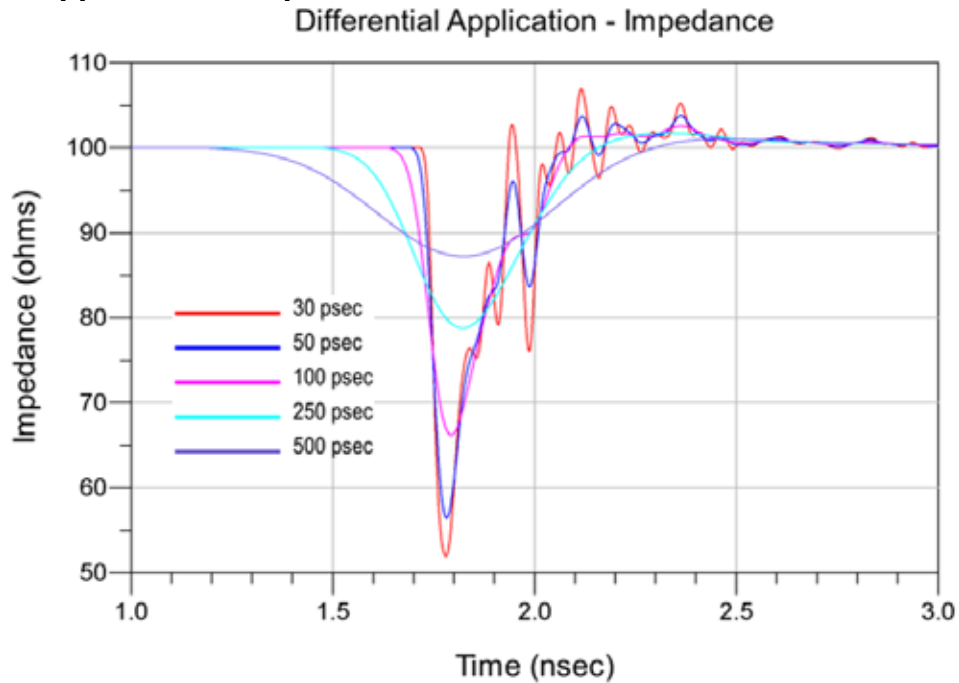

### Differential Application – Propagation Delay

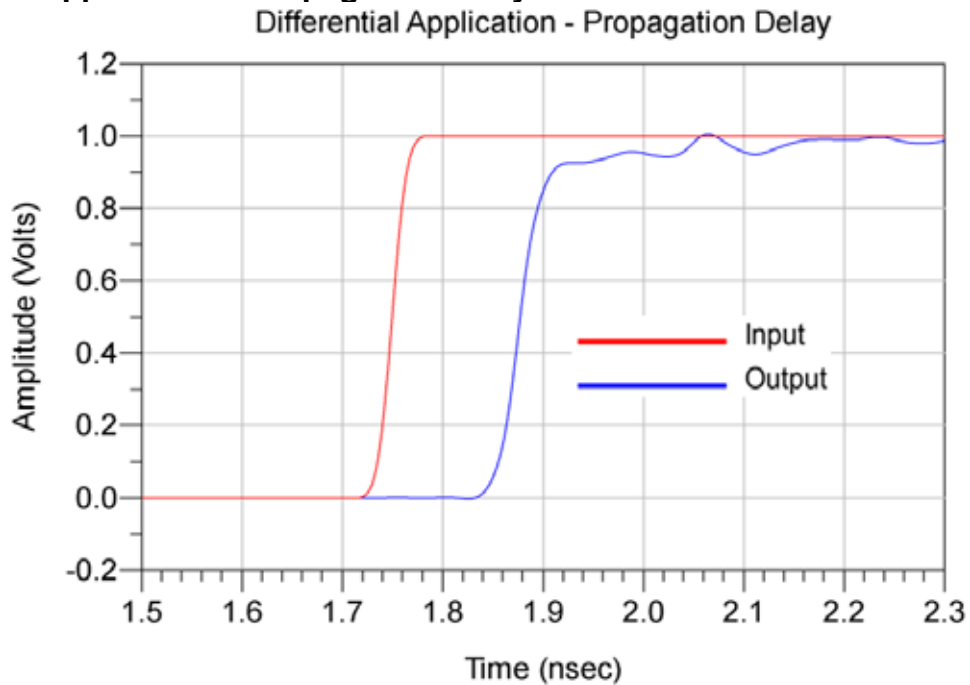

Series: QTE/QSE

Description: High Speed Ground Plane Header, 0.8mm (.0315") Pitch, 16mm (.630") Stack Height

## Differential Application – NEXT, Worst Case Configuration

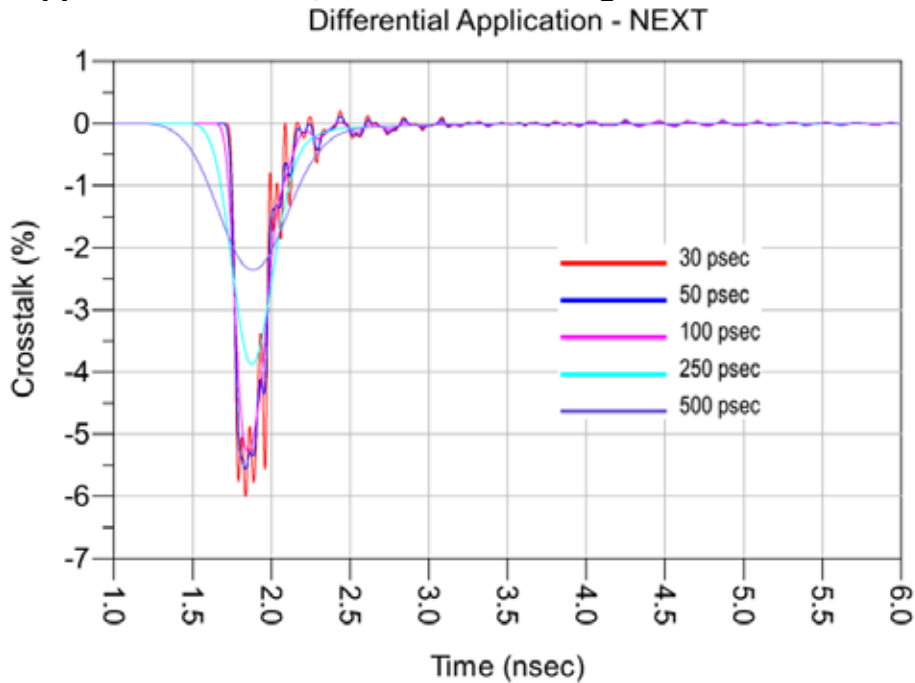

## Differential Application – FEXT, Worst Case Configuration

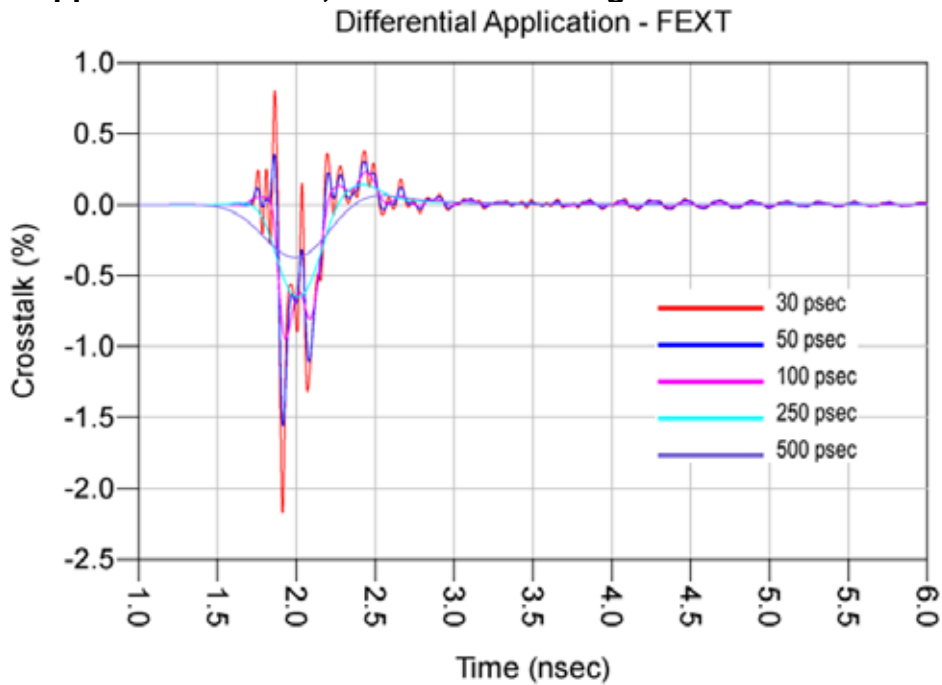

Series: QTE/QSE

Description: High Speed Ground Plane Header, 0.8mm (.0315") Pitch, 16mm (.630") Stack Height

## Differential Application – NEXT, Best Case Configuration

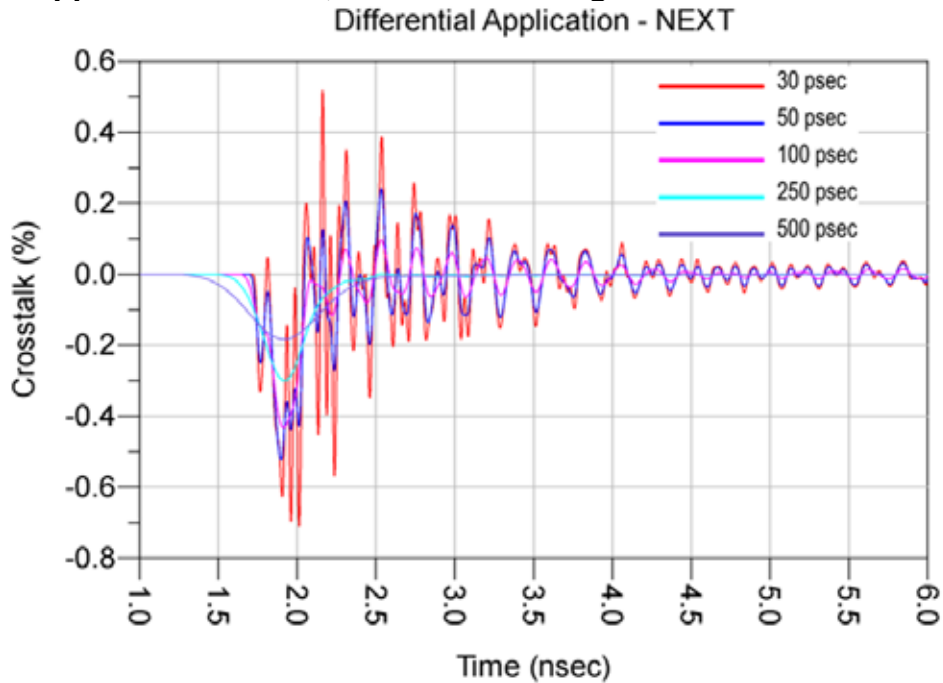

## Differential Application – FEXT, Best Case Configuration

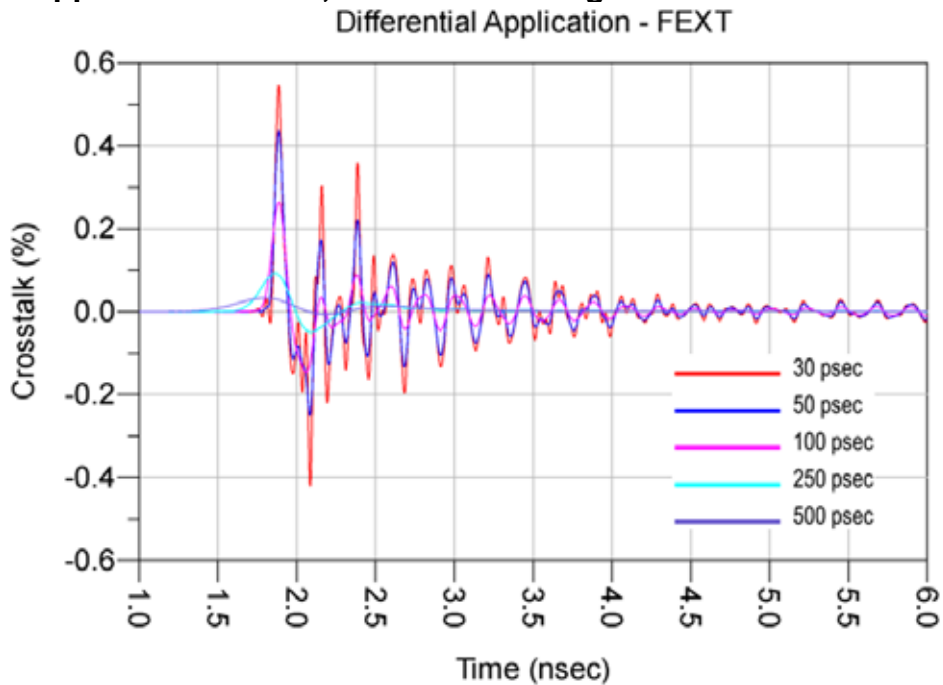

Series: QTE/QSE

Description: High Speed Ground Plane Header, 0.8mm (.0315") Pitch, 16mm (.630") Stack Height

## Differential Application – NEXT, Across Row Case Configuration

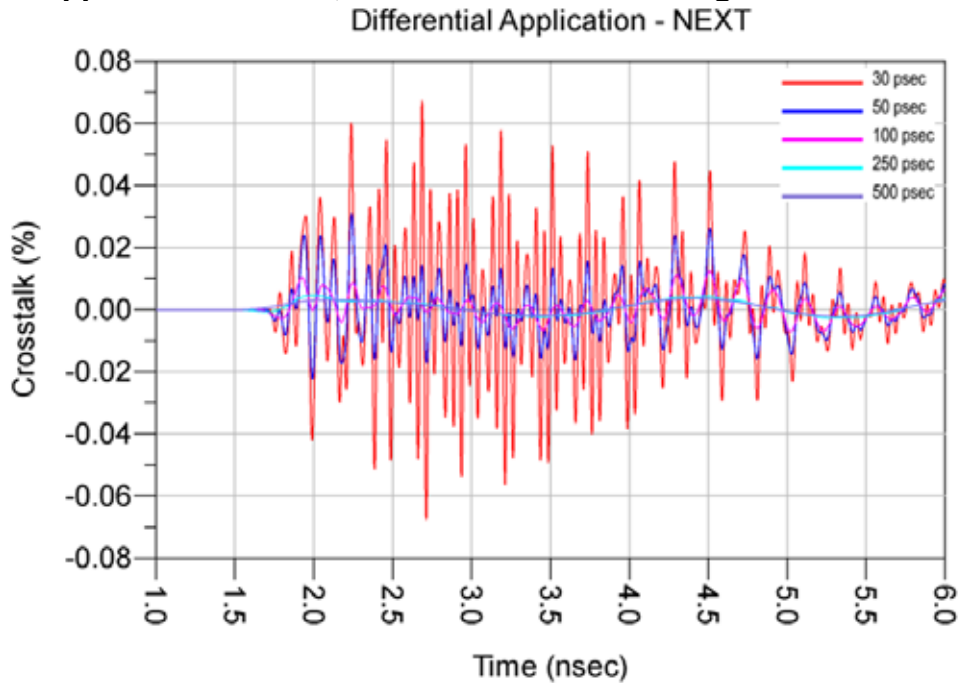

## Differential Application – FEXT, Across Row Case Configuration

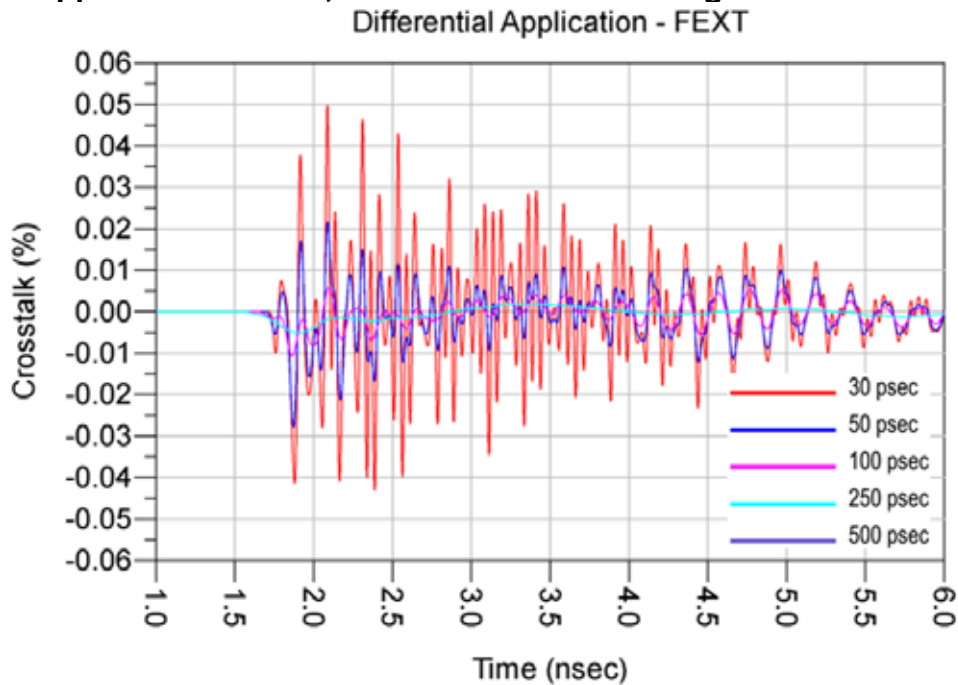

**Series:** QTE/QSE

**Description:** High Speed Ground Plane Header, 0.8mm (.0315") Pitch, 16mm (.630") Stack Height

## Appendix C – Product and Test System Descriptions

### Product Description

Product test samples are QTE/QSE High Speed Ground Plane Header. The part number is QTE-020-04-L-D-A-TR and it mates to QSE-020-01-L-D-A-TR. The connector has two rows of 20 contacts evenly spaced on a 0.8 mm (0.0315") pitch. A photo of the mated test article mounted to SI test boards is shown at right.



### Test System Description

The test fixtures are composed of four-layer FR-406 material with 50Ω signal trace and pad configurations designed for the electrical characterization of Samtec high speed connector products. A PCB mount SMA connector is used to interface the VNA test cables to the test fixtures. SMA launch optimization is attained using full wave simulation tools to minimize reflections. There are 11 test fixtures specific to the QTE/QSE series connector set. Ten of the 11 fixtures mate to comprise a full hi-speed characterization test. The remaining board contains the SMA/LRM calibration structures designed specifically for the QTE/QSE series. Displayed on the following pages is information for the SMA/LRM calibration structure and directives for mating QTE/QSE fixtures.

### PCB-103741-TST-XX Test Fixtures

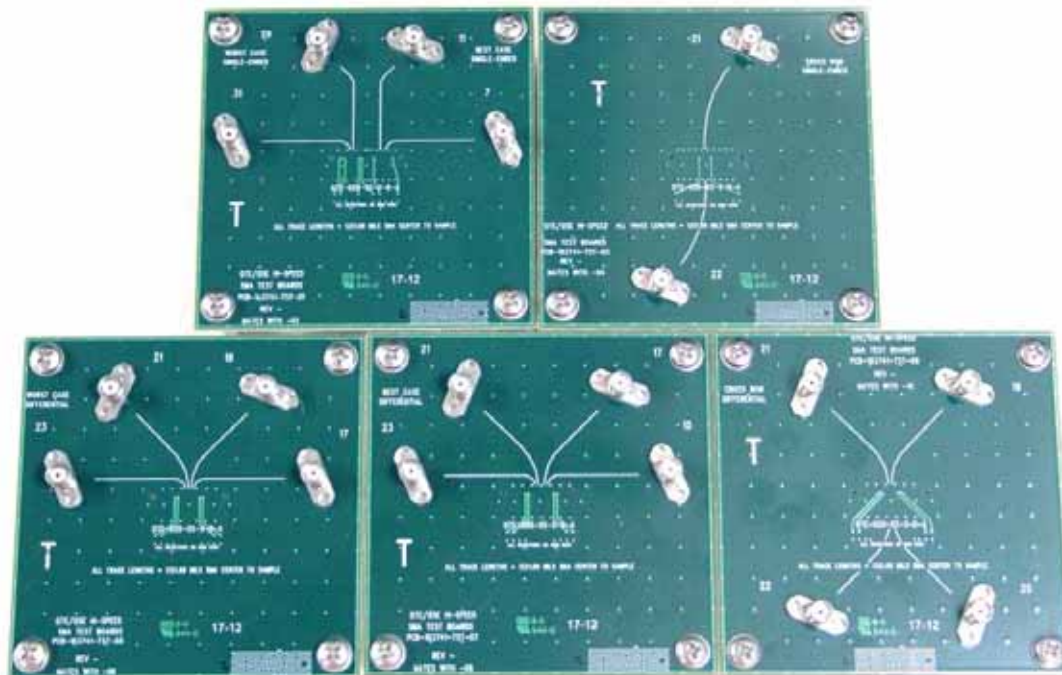

**Series:** QTE/QSE

**Description:** High Speed Ground Plane Header, 0.8mm (.0315") Pitch, 16mm (.630") Stack Height

## PCB-103741-TST-XX PCB Layout Panel

PCB design artwork shown below.

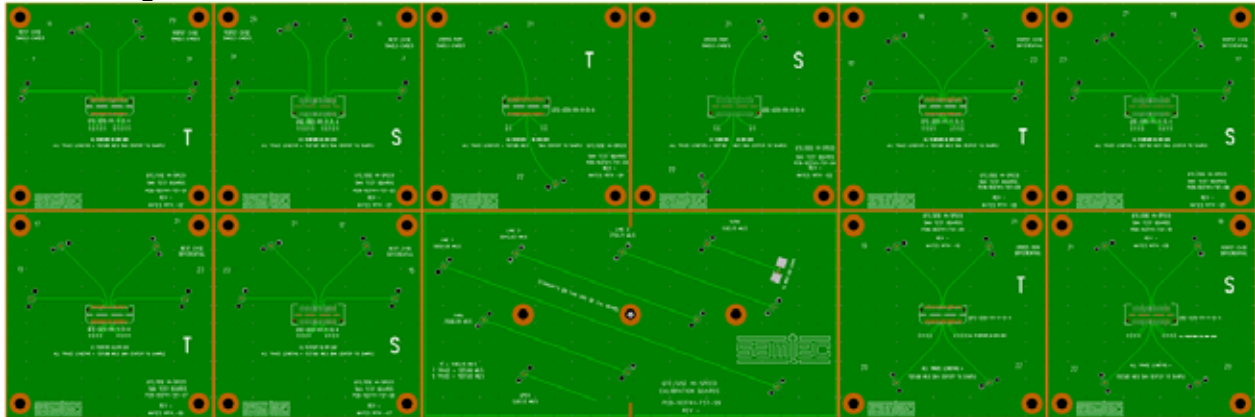

## PCB Fixtures

The test fixtures used are as follows:

PCB-103741 -TST-01 Rev - QTE/QSE Hi-Speed SMA Test Board *mates with* PCB-103741 -TST-02 Rev - QTE/QSE Hi-Speed SMA Test Board Single-Ended Best & Worst Case Configurations. Transmission/ Reflection Parameters, Crosstalk Parameters

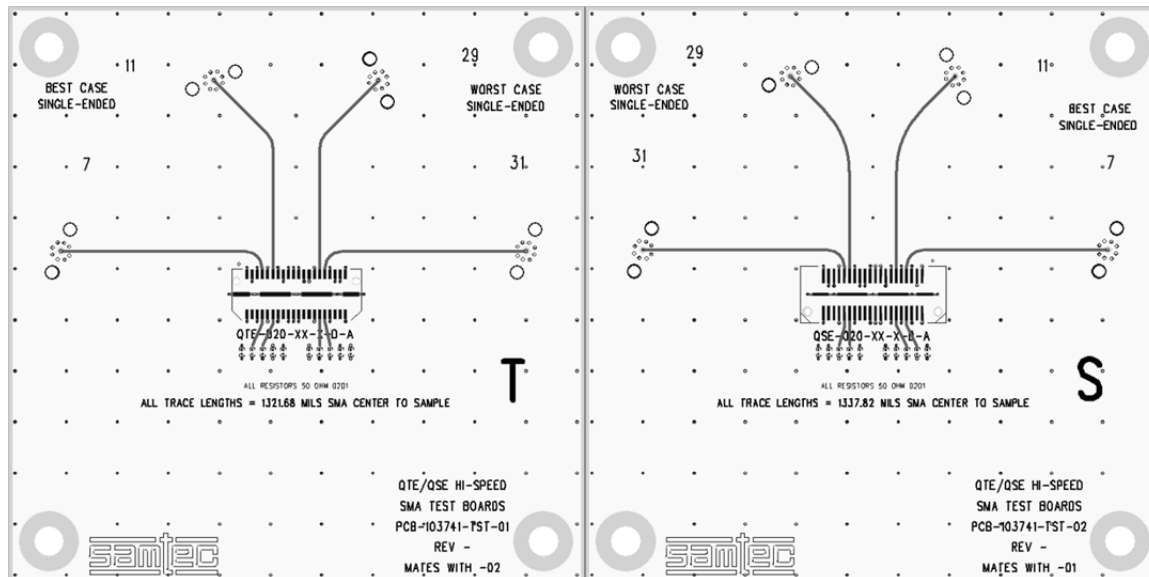

**Series:** QTE/QSE

**Description:** High Speed Ground Plane Header, 0.8mm (.0315") Pitch, 16mm (.630") Stack Height

## PCB Fixtures (Cont.)

PCB-103741 -TST-03 Rev - QTE/QSE Hi-Speed SMA Test Board *mates with* PCB-103741 -TST-04 Rev - QTE/QSE Hi-Speed SMA Test Board Single Ended Cross Row Configurations. Crosstalk Parameters

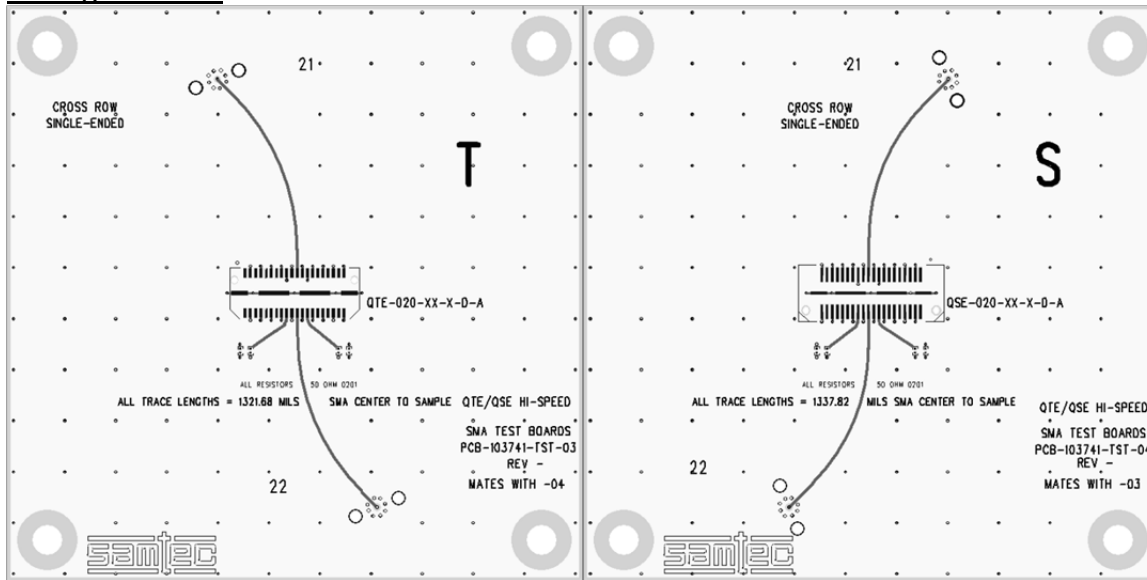

PCB-103741 -TST-05 Rev - QTE/QSE Hi-Speed SMA Test Board *mates with* PCB-103741 -TST-06 Rev - QTE/QSE Hi-Speed SMA Test Board Differential Worst Case Configurations. Crosstalk Parameters

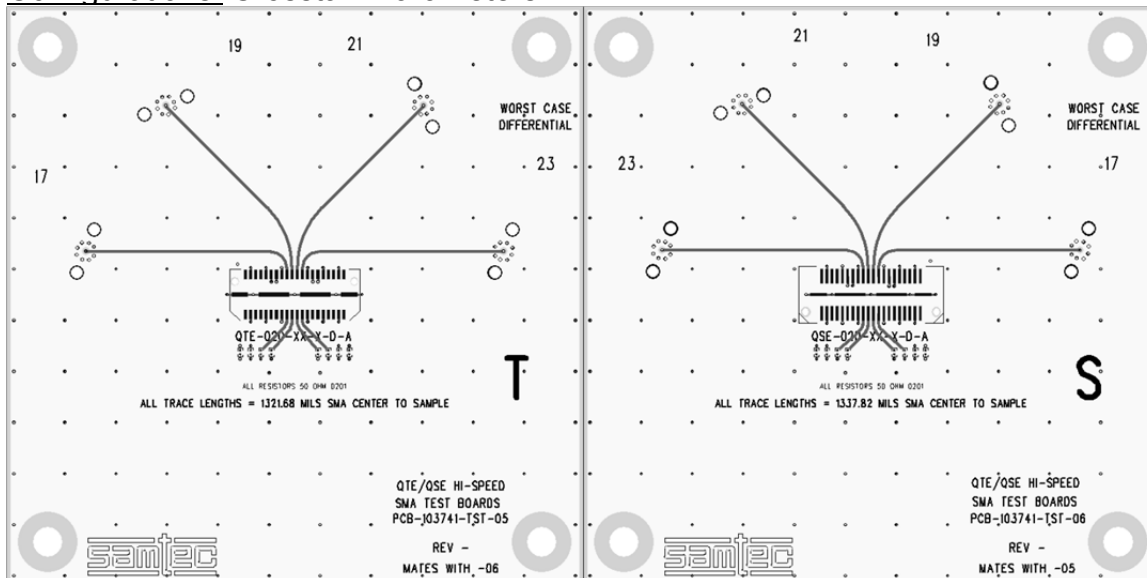

**Series:** QTE/QSE

**Description:** High Speed Ground Plane Header, 0.8mm (.0315") Pitch, 16mm (.630") Stack Height

## PCB Fixtures (Cont.)

PCB-103741 -TST-07 Rev - QTE/QSE Hi-Speed SMA Test Board *mates with* PCB-103741 -TST-08 Rev - QTE/QSE Hi-Speed SMA Test Board Differential Best Case Configurations. Transmission/Reflection Parameters, Crosstalk Parameters

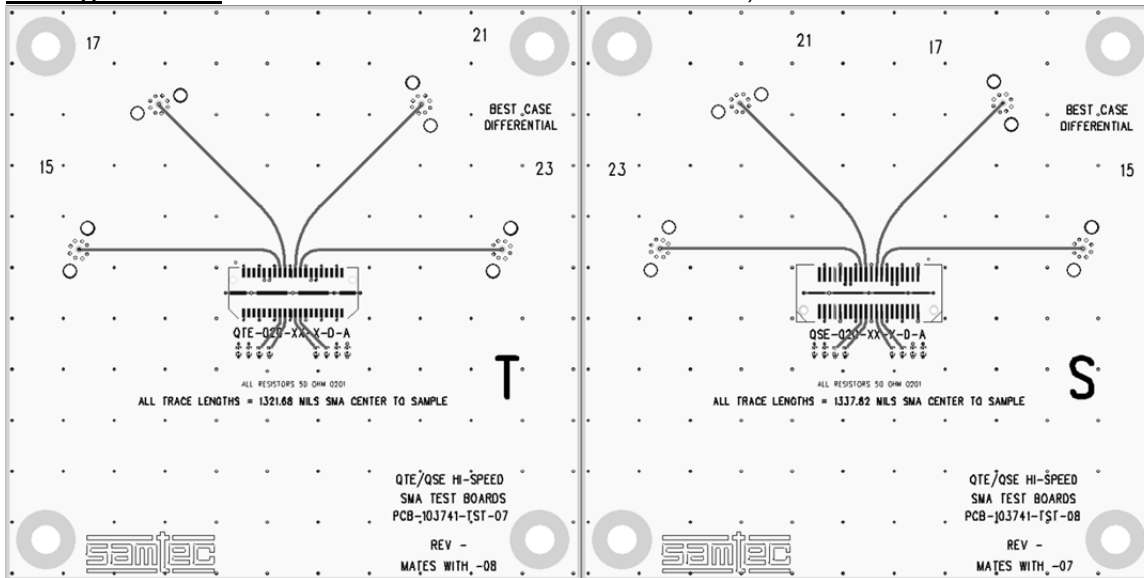

PCB-103741 -TST-09 Rev - QTE/QSE Hi-Speed SMA Test Board *mates with* PCB-103741 -TST-10 Rev - QTE/QSE Hi-Speed SMA Test Board Differential Cross Row Configurations. Crosstalk Parameters

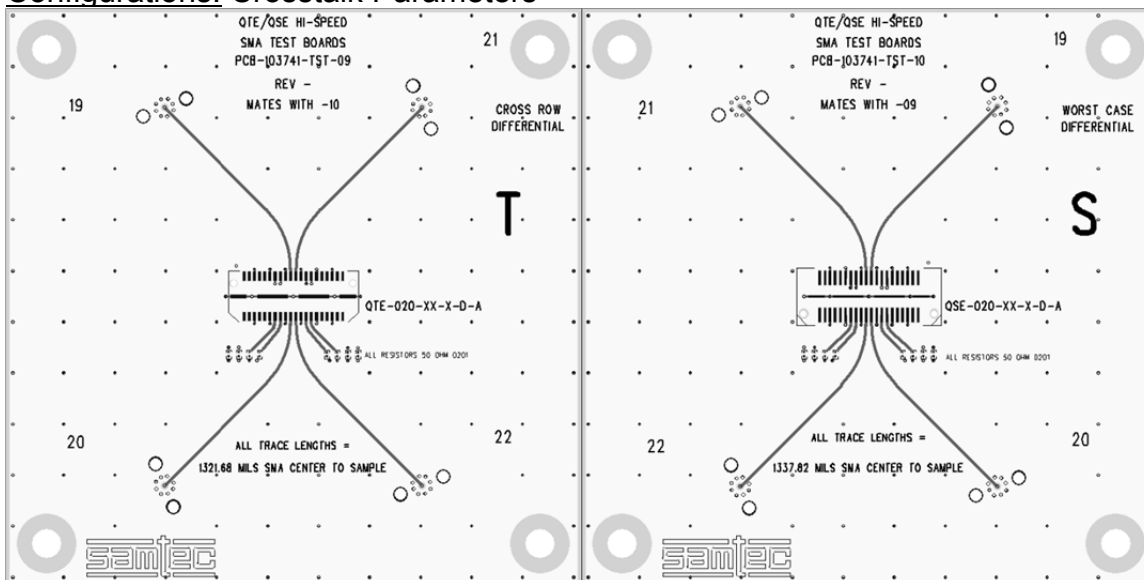

**Series:** QTE/QSE**Description:** High Speed Ground Plane Header, 0.8mm (.0315") Pitch, 16mm (.630") Stack Height**Calibration Board**

Test fixture losses and test point reflections were removed from the data by use of LRM calibration. The calibration boards are shown below. Prior to making any measurements, the calibration board is characterized to obtain parameters required to define the calibration kit. Once a cal kit is defined, calibration using the standards on the calibration board can be performed. Finally, the device can be measured and the test board effects are automatically removed.

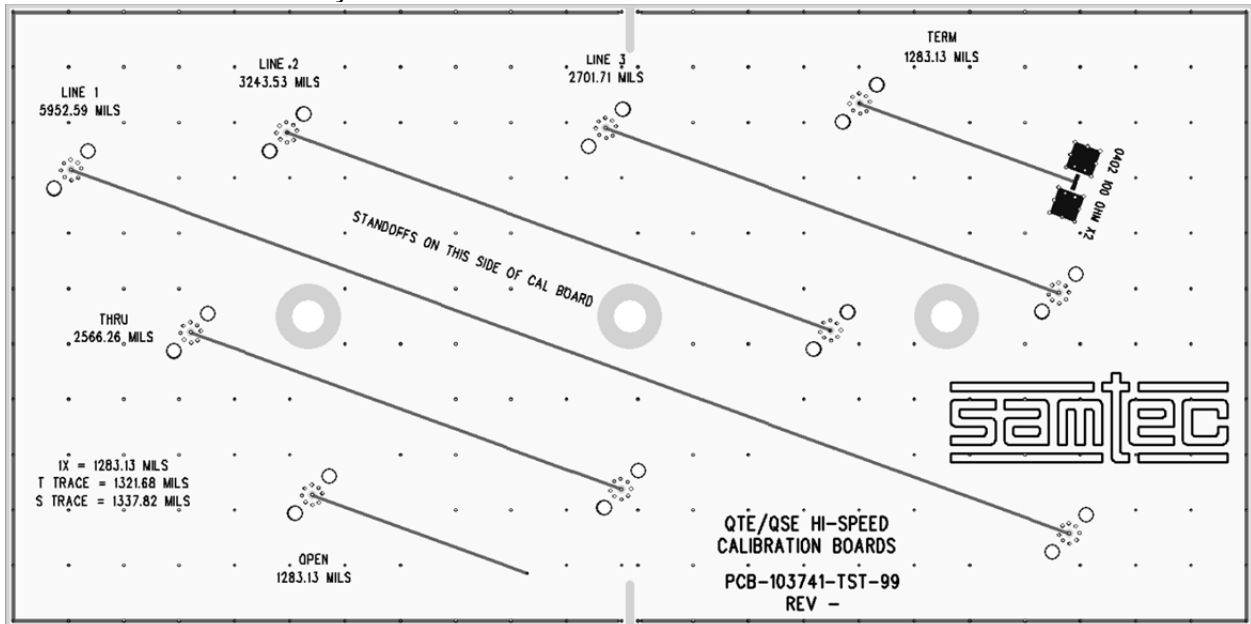
**Line - Reflect - Match (LRM) Calibration Standards****PCB-103741-TST-99**

Line 1 - Length = 5952.59 mils  
Line 2 - Length = 3243.53 mils  
Line 3 - Length = 2701.71 mils

Thru Line (2X) = 2566.26 mils  
Reflect Standard - Length = 1283.13 mils  
Match Standard - Length = 1283.13 mils

**Series:** QTE/QSE

**Description:** High Speed Ground Plane Header, 0.8mm (.0315") Pitch, 16mm (.630") Stack Height

All traces on the QTE test boards are length matched to 1321.68 mils measured from the center of the signal pad to the SMA center contact pad. All traces on the QSE test boards are length matched to 1337.82 mils measured from the center of the signal pad to the SMA center contact pad. The LRM calibration effectively removes 1283.13 mils of PCB signal trace effects. Since the footprint geometry is 16.14 mils longer on the QSE connector, the reference plane location is an equal distance from the edge of the connectors signal pads. The calibrated reference plane is located 10 mils from the connector pad on each side. The S-Parameter measurements include:

- A. The QTE/QSE Series connector set
- B. Test board vias, pads (footprint effects) for the QTE connector side.
- C. 10 mils of 16 mil wide microstrip signal trace
- D. Test board vias, pads (footprint effects) for the QSE connector side.
- E. 10 mils of 16 mil wide microstrip signal trace

The figure below shows the location of the measurement reference plane.

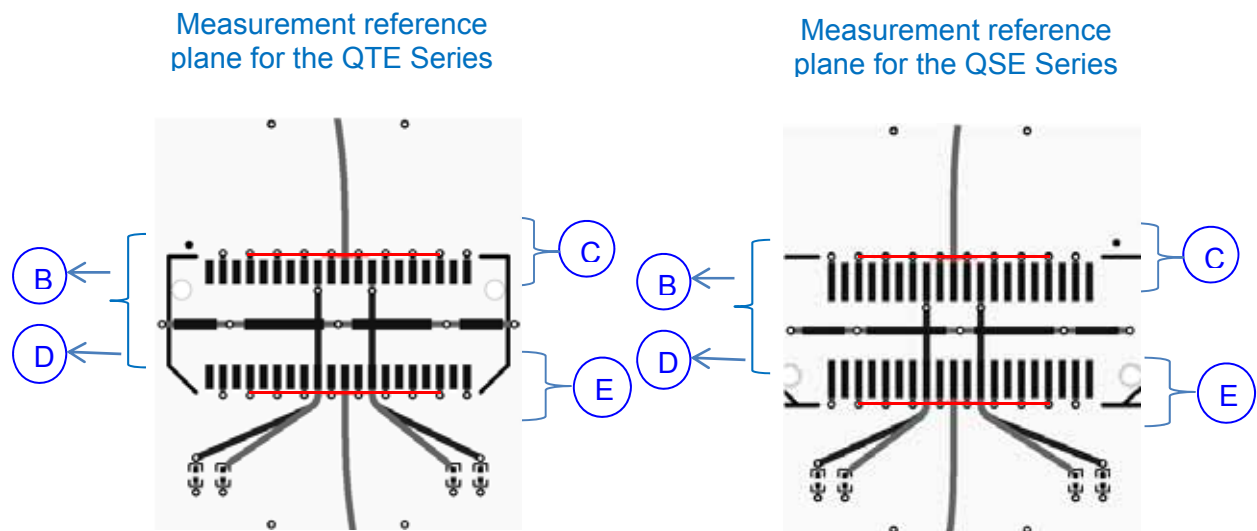

**Series:** QTE/QSE

**Description:** High Speed Ground Plane Header, 0.8mm (.0315") Pitch, 16mm (.630") Stack Height

## Appendix D – Test and Measurement Setup

The test instrument is the Agilent N5230C PNA-L network analyzer. Frequency domain data and graphs are obtained directly from the instrument. Post-processed time domain data and graphs are generated using convolution algorithms within Agilent ADS. The network analyzer is configured as follows:

Start Frequency – 300 KHz                      Number of points -1601  
Stop Frequency – 20 GHz                      IFBW – 1 KHz

With these settings, the measurement time is approximately 20 seconds.

### N5230C Measurement Setup

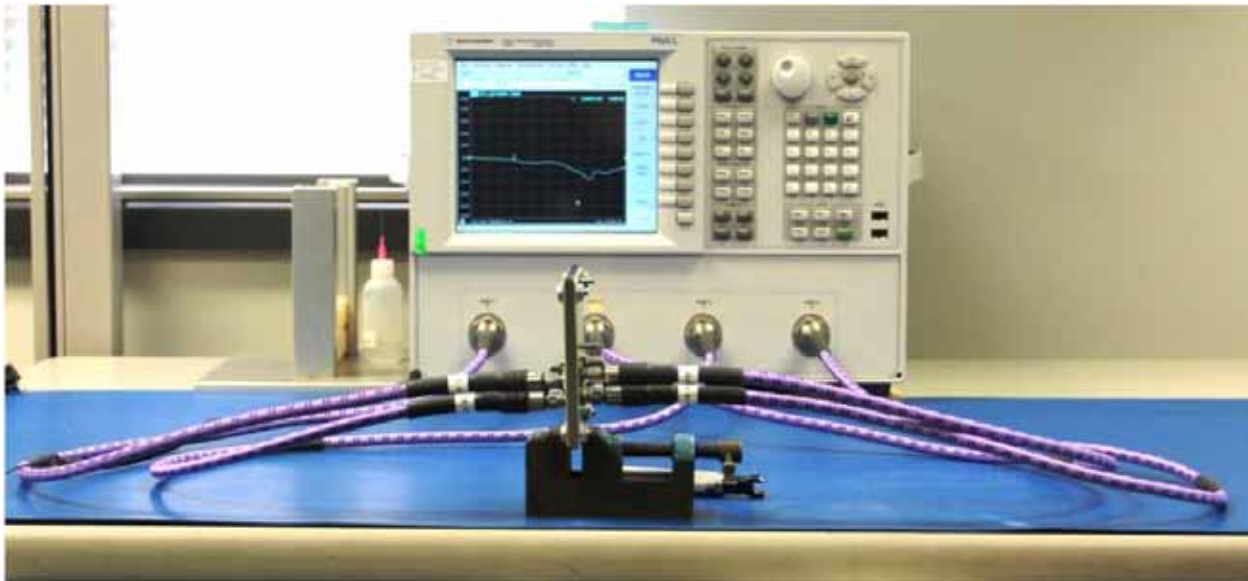

### Test Instruments

<u>QTY</u>	<u>Description</u>
1	Agilent N5230C PNA-L 4-Port Network Analyzer (300 KHz to 20 GHz)
1	Agilent N4433A Ecal module (300 KHz to 20 GHz)

### Test Cables & Adapters

<u>QTY</u>	<u>Description</u>
4	WL Gore –Z0CJ0CK0360 3.5 mm(f) to 3.5mm(m) Test Port Cables

**Series:** QTE/QSE

**Description:** High Speed Ground Plane Header, 0.8mm (.0315") Pitch, 16mm (.630") Stack Height

## **Appendix E - Frequency and Time Domain Measurements**

### **Frequency (S-Parameter) Domain Procedures**

The quality of any data taken with a network analyzer is directly related to the quality of the calibration standards and the use of proper test procedures. For this reason, extreme care is taken in the design of the LRM calibration standards, the SI test boards, and the selection of the PCB vendor.

The measurement process begins with a measurement of the LRM calibration standards. A coaxial SOLT calibration is performed using an N4433A E-cal module. This measurement is required in order to obtain precise values of the line standard offset delay and frequency bandwidths. Measurements of the reflect and 2x through line standard can be used to determine the maximum frequency for which the calibration standards are valid. For the QTE/QSE Series test boards, this is greater than 20 GHz.

From the LRM calibration standard measurements, a user defined calibration kit is developed and stored in the network analyzer. Calibration is then performed on all 4 ports following the calibration wizard within the Agilent N5230C. This calibration is saved and can be recalled at any time. Calibration takes roughly 30 minutes to perform.

### **Time Domain Procedures**

Mathematically, Frequency Domain data can be transformed to obtain a Time Domain response. Perfect transformation requires Frequency Domain data from DC to infinity Hz. Fortunately, a very accurate Time Domain response can be obtained with bandwidth-limited data, such as measured with modern network analyzer.

The Time Domain responses were generated using Agilent ADS 2011 update 10. This tool has a transient convolution simulator, which can generate a Time Domain response directly from measured S-Parameters. An example of a similar methodology is provided in the Samtec Technical Note on domain transformation.

[http://www.samtec.com/Technical\\_Library/reference/articles/pdfs/tech-note\\_using-PLTS-for-time-domain-data\\_web.pdf](http://www.samtec.com/Technical_Library/reference/articles/pdfs/tech-note_using-PLTS-for-time-domain-data_web.pdf)

### **Impedance (TDR)**

A step pulse is applied to the touchstone model of the connector and the reflected voltage is monitored. The reflected voltage is converted to a reflection coefficient and then transformed into an impedance profile. All ports of the Touchstone model are terminated in 50 ohms.

**Series:** QTE/QSE

**Description:** High Speed Ground Plane Header, 0.8mm (.0315") Pitch, 16mm (.630") Stack Height

### Propagation Delay (TDT)

The Propagation Delay is a measure of the Time Domain delay through the connector and footprint. A step pulse is applied to the touchstone model of the connector and the transmitted voltage is monitored. The same pulse is also applied to a reference channel with zero loss, and the Time Domain pulses are plotted on the same graph. The difference in time, measured at the 50% point of the step voltage is the propagation delay.

### Near-End Crosstalk (TDT) & Far End Crosstalk (TDT)

A step pulse is applied to the touchstone model of the connector and the coupled voltage is monitored. The amplitude of the peak-coupled voltage is recorded and reported as a percentage of the input pulse.

**Series:** QTE/QSE

**Description:** High Speed Ground Plane Header, 0.8mm (.0315") Pitch, 16mm (.630") Stack Height

## **Appendix F – Glossary of Terms**

ADS – Advanced Design Systems

BC – Best Case crosstalk configuration

DUT – Device under test, term used for TDA IConnect & Propagation Delay waveforms

FD – Frequency domain

FEXT – Far-End Crosstalk

GSG – Ground–Signal–Ground; geometric configuration

GSSG - Ground–Signal–Signal–Ground; geometric configuration

HDV – High Density Vertical

NEXT – Near-End Crosstalk

OV – Optimal Vertical

OH – Optimal Horizontal

PCB – Printed Circuit Board

PPO – Pin Population Option

SE – Single-Ended

SI – Signal Integrity

SUT – System Under Test

S – Static (independent of PCB ground)

SOLT – acronym used to define Short, Open, Load & Thru Calibration Standards

TD – Time Domain

TDA – Time Domain Analysis

TDR – Time Domain Reflectometry

TDT – Time Domain Transmission

WC – Worst Case crosstalk configuration

Z – Impedance (expressed in ohms)