



High Speed Characterization Report

QTH-030-07-L-D-A



Mates with

QSH-030-01-L-D-A

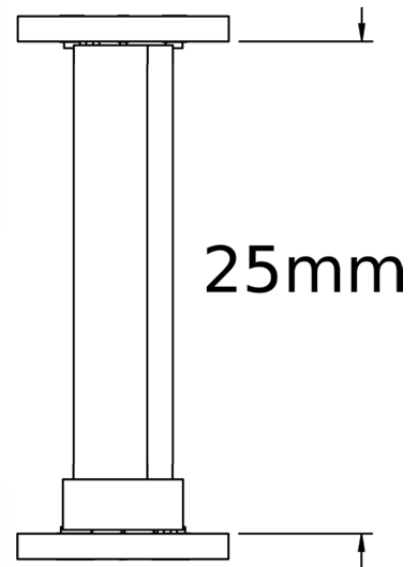

Description:

**High Speed Ground Plane Header
Board-to-Board, 0.5mm (.0197") Pitch, 25mm (.984") Stack Height**

Series: QTH/QSH**Description:** High Speed Ground Plane Header, 0.5mm (.0197") Pitch, 25mm (.984") Stack Height

Table of Contents

Connector Overview	1
Frequency Domain Data Summary	2
Bandwidth Chart – Single-Ended & Differential Insertion Loss	3
Time Domain Data Summary	4
Characterization Details	7
Differential and Single-Ended Data	7
Connector Signal to Ground Ratio	7
Frequency Domain Data	9
Time Domain Data	9
Appendix A – Frequency Domain Response Graphs	11
Single-Ended Application – Insertion Loss	11
Single-Ended Application – Return Loss	11
Single-Ended Application – NEXT Configurations	12
Single-Ended Application – FEXT Configurations	12
Differential Application – Insertion Loss	13
Differential Application – Return Loss	13
Differential Application – NEXT Configurations	14
Differential Application – FEXT Configurations	14
Appendix B – Time Domain Response Graphs	15
Single-Ended Application – Input Pulse	15
Single-Ended Application – Impedance	16
Single-Ended Application – Propagation Delay	16
Single-Ended Application – NEXT, Worst Case Configuration	17
Single-Ended Application – FEXT, Worst Case Configuration	17
Single-Ended Application – NEXT, Best Case Configuration	18
Single-Ended Application – FEXT, Best Case Configuration	18
Single-Ended Application – NEXT, Across Row Configuration	19
Single-Ended Application – FEXT, Across Row Configuration	19
Differential Application – Input Pulse	20
Differential Application – Impedance	21
Differential Application – Propagation Delay	21
Differential Application – NEXT, Worst Case Configuration	22
Differential Application – FEXT, Worst Case Configuration	22
Differential Application – NEXT, Best Case Configuration	23
Differential Application – FEXT, Best Case Configuration	23
Differential Application – NEXT, Across Row Case Configuration	24
Differential Application – FEXT, Across Row Case Configuration	24
Appendix C – Product and Test System Descriptions	25
Product Description	25

Series: QTH/QSH

Description: High Speed Ground Plane Header, 0.5mm (.0197”) Pitch, 25mm (.984”) Stack Height

Test System Description	25
PCB-103842-TST-XX Test Fixtures.....	25
PCB-103842-TST-XX PCB Layout Panel	26
PCB Fixtures	27
Calibration Board	29
N5230C Measurement Setup	32
Test Instruments	32
Test Cables & Adapters	32
Appendix E - Frequency and Time Domain Measurements	33
Frequency (S-Parameter) Domain Procedures	33
Time Domain Procedures	33
Impedance (TDR).....	33
Propagation Delay (TDT)	34
Near-End Crosstalk (TDT) & Far End Crosstalk (TDT)	34
Appendix F – Glossary of Terms	35

Series: QTH/QSH

Description: High Speed Ground Plane Header, 0.5mm (.0197") Pitch, 25mm (.984") Stack Height

Connector Overview

Samtec's QTH/QSH High Speed Ground Plane Header is designed for high-speed board-to-board applications where signal integrity is essential. The connectors have surface mount contacts as well as a surface mount ground plane between the two rows of signals for improved electrical performance. QTH/QSH is a double row contacts system available with up to 240 I/Os in stack heights from 5mm (.197") through 30mm (1.180"). The data in this report is applicable only to a 25mm stack height.

Connector System Speed Rating

QTH/QSH High Speed Ground Plane Connector, Board-to-Board, 0.5mm (.0197") Pitch, 25mm (0.984") Stack Height

<u>Signaling</u>	<u>Speed Rating</u>
Single-Ended:	3.5 GHz/ 7Gbps
Differential:	8.5 GHz/ 17Gbps

The Speed Rating is based on the -3 dB insertion loss point of the connector system. The -3 dB point can be used to estimate usable system bandwidth in a typical, two-level signaling environment. To calculate the Speed Rating, the measured -3 dB point is rounded-up to the nearest half-GHz level. The up rounding corrects for a portion of the test board's trace loss, since a short length of trace loss included in the loss data in this report. The resulting loss value is then doubled to determine the approximate maximum data rate in Gigabits per second (Gbps).

For example, a connector with a -3 dB point of 7.8 GHz would have a Speed Rating of 8 GHz/ 16 Gbps. A connector with a -3 dB point of 7.2 GHz would have a Speed Rating of 7.5 GHz/ 15 Gbps.

Series: QTH/QSH

Description: High Speed Ground Plane Header, 0.5mm (.0197") Pitch, 25mm (.984") Stack Height

Frequency Domain Data Summary

Table 1 - Single-Ended Connector System Performance		
Test Parameter	Configuration	
Insertion Loss	GSG	3dB @ 3.05 GHz
Return Loss	GSG	>10dB to 1.313 GHz
Near-End Crosstalk	GAQG	< -20dB to 0.238 GHz
	GAGQG	< -20dB to 13.363 GHz
	Xrow, GAG to GQG	< -20dB to 20 GHz
Far-End Crosstalk	GAQG	< -20dB to 2.463 GHz
	GAGQG	< -20dB to 16.075 GHz
	Xrow, GAG to GQG	< -20dB to 20 GHz

Table 2 - Differential Connector System Performance		
Test Parameter	Configuration	
Insertion Loss	GSSG	3dB @ 8.1 GHz
Return Loss	GSSG	>10dB to 0.563 GHz
Near-End Crosstalk	GAAQQG	< -20dB to 0.8 GHz
	GAAGQQG	< -20dB to 17.2 GHz
	Xrow, GAAG to GQQG	< -20dB to 18.125 GHz
Far-End Crosstalk	GAAQQG	< -20dB to 20 GHz
	GAAGQQG	< -20dB to 20 GHz
	Xrow, GAAG to GQQG	< -20dB to 20 GHz

Series: QTH/QSH

Description: High Speed Ground Plane Header, 0.5mm (.0197") Pitch, 25mm (.984") Stack Height

Bandwidth Chart – Single-Ended & Differential Insertion Loss

QTH/QSH Ground Plane Header Series

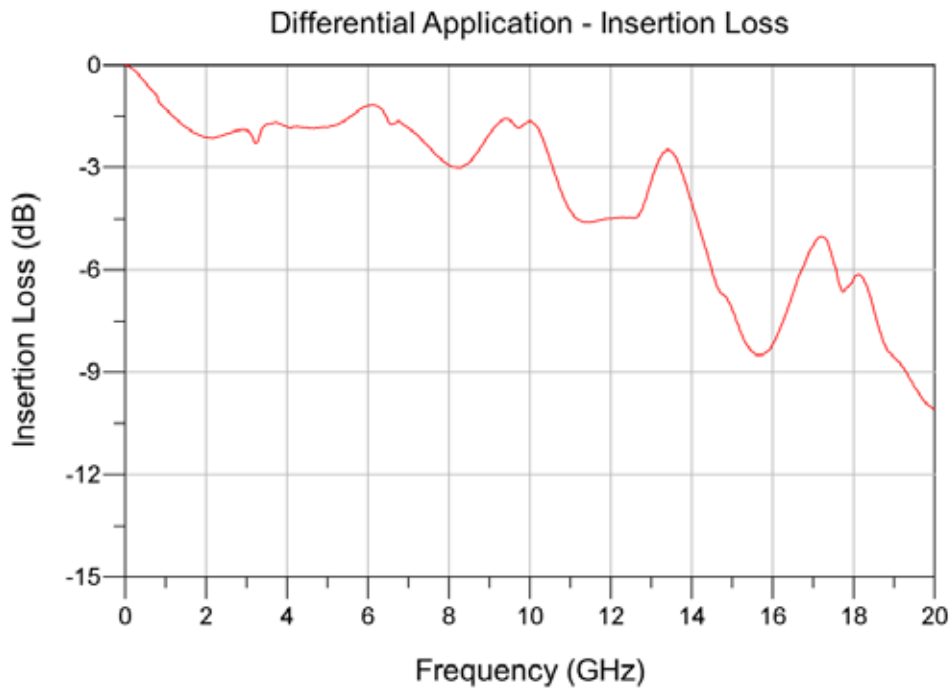
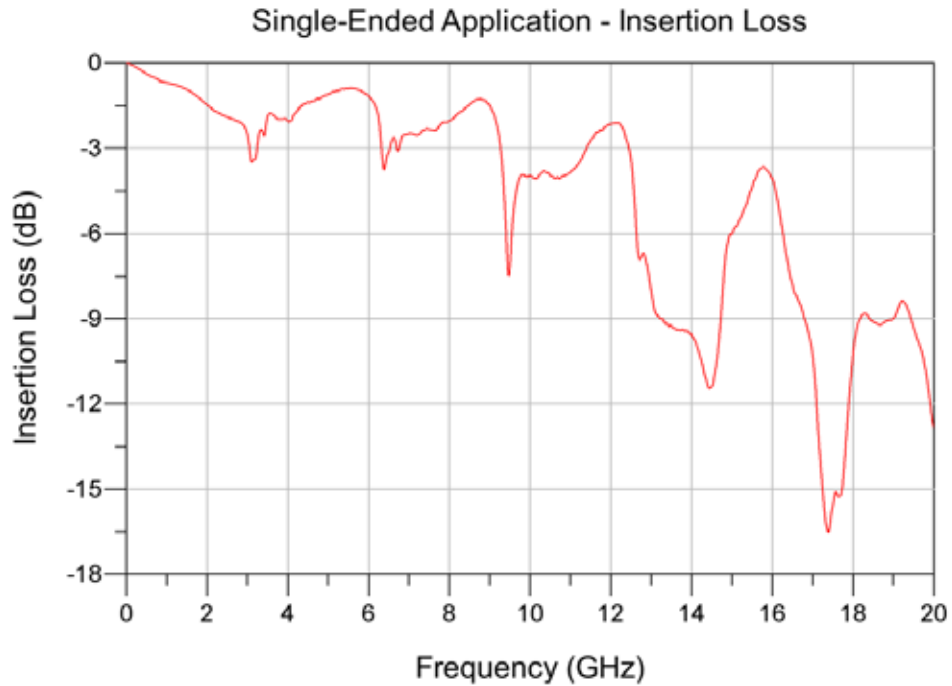

Series: QTH/QSH

Description: High Speed Ground Plane Header, 0.5mm (.0197") Pitch, 25mm (.984") Stack Height

Time Domain Data Summary

Table 3 – Single-End Impedance (Ω)					
Signal Risetime	30 ps	50 ps	100 ps	250 ps	500 ps
Maximum Impedance	57.5	55.9	53.3	51.0	50.1
Minimum Impedance	29.0	29.3	30.6	36.8	39.7

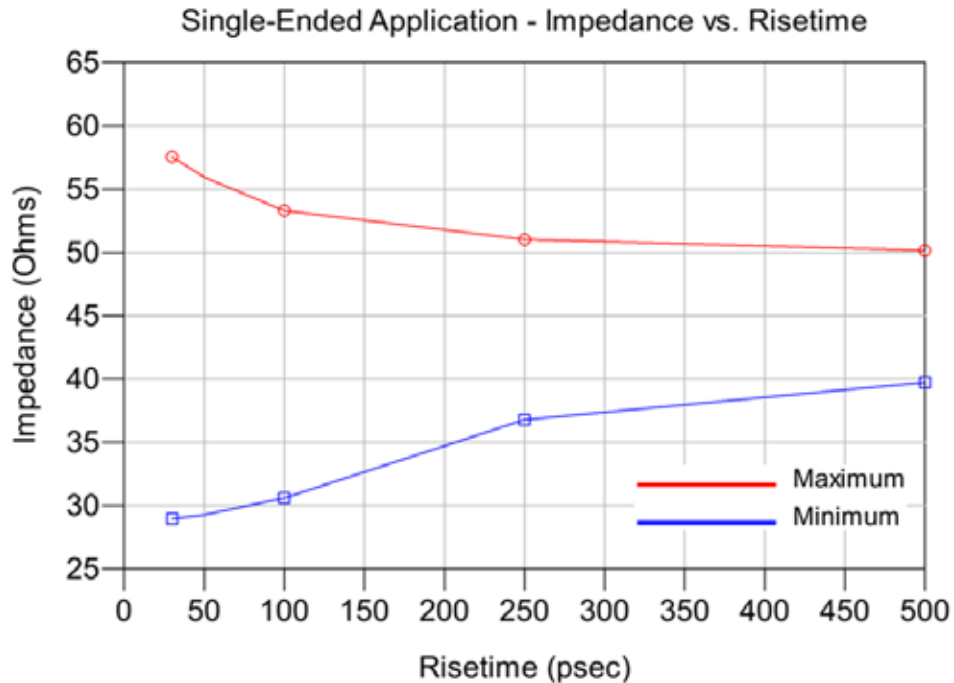

Series: QTH/QSH

Description: High Speed Ground Plane Header, 0.5mm (.0197") Pitch, 25mm (.984") Stack Height

Table 4 - Differential Impedance (Ω)					
Signal Risetime	30 ps	50 ps	100 ps	250 ps	500 ps
Maximum Impedance	100.7	100.7	100.6	100.5	100.4
Minimum Impedance	42.2	42.6	45.7	57.6	70.7

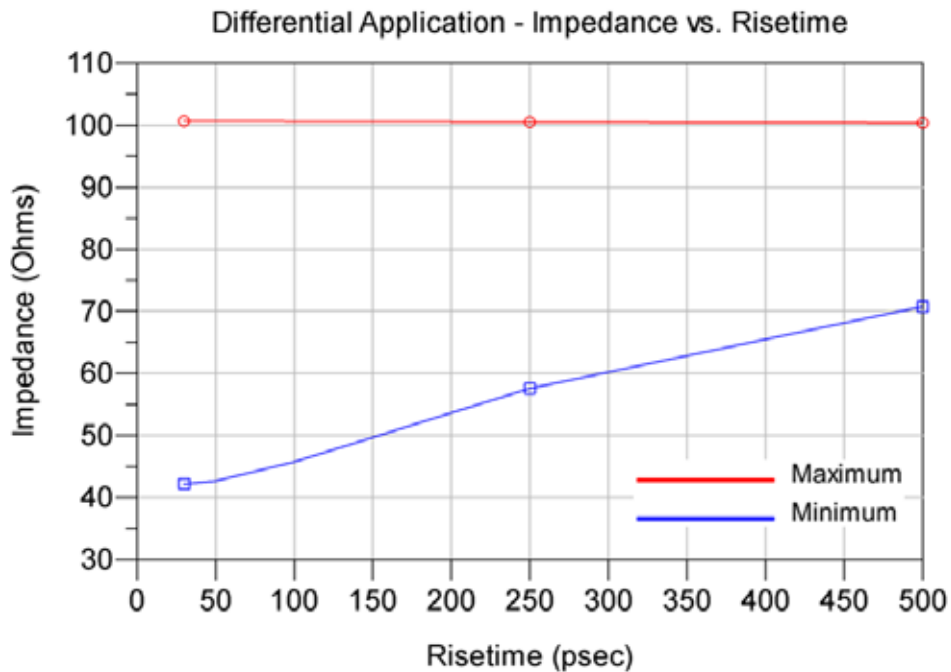

Series: QTH/QSH

Description: High Speed Ground Plane Header, 0.5mm (.0197") Pitch, 25mm (.984") Stack Height

Table 5 - Single-Ended Crosstalk (%)						
Input(tr)		30ps	50 ps	100 ps	250 ps	500 ps
NEXT	GAQG	22.0	20.5	19.5	17.2	11.6
	GAGQG	3.9	2.8	2.2	1.6	1.1
	Xrow	0.2	0.2	< 0.1%	< 0.1%	< 0.1%
FEXT	GAQG	7.0	5.1	3.6	2.4	1.3
	GAGQG	1.5	1.4	0.9	0.4	0.1
	Xrow	0.2	0.1	< 0.1%	< 0.1%	< 0.1%

Table 6 - Differential Crosstalk (%)						
Input(tr)		30ps	50 ps	100 ps	250 ps	500 ps
NEXT	GAAQQG	8.0	7.9	7.7	6.5	4.6
	GAAGQQG	0.7	0.4	0.3	0.2	0.2
	Xrow	0.1	< 0.1%	< 0.1%	< 0.1%	< 0.1%
FEXT	GAAQQG	4.6	4.6	4.4	3.6	2.5
	GAAGQQG	0.6	0.4	0.3	0.2	< 0.1%
	Xrow	< 0.1%	< 0.1%	< 0.1%	< 0.1%	< 0.1%

Table 7 - Propagation Delay (Mated Connector)	
Single-Ended	154 ps
Differential	138 ps

Series: QTH/QSH

Description: High Speed Ground Plane Header, 0.5mm (.0197") Pitch, 25mm (.984") Stack Height

Characterization Details

This report presents data that characterizes the signal integrity response of a connector pair in a controlled printed circuit board (PCB) environment. All efforts are made to reveal typical best-case responses inherent to the system under test (SUT).

In this report, the SUT includes the connector pair and footprint effects on a typical multi-layer PCB. PCB effects (trace loss) are de-embedded from test data. Board related effects, such as pad-to-ground capacitance, are included in the data presented in this report.

Additionally, intermediate test signal connections can mask the connector's true performance. Such connection effects are minimized by using high performance test cables and adapters. Where appropriate, calibration and de-embedding routines are also used to reduce residual effects.

Differential and Single-Ended Data

Most Samtec connectors can be used successfully in both differential and single-ended applications. However, electrical performance will differ depending on the signal drive type. In this report, data is presented for both differential and single-ended drive scenarios.

Connector Signal to Ground Ratio

Samtec connectors are most often designed for generic applications and can be implemented using various signal and ground pin assignments. In high-speed systems, provisions must be made in the interconnect for signal return currents. Such paths are often referred to as "ground". In some connectors, a ground plane or blade, or an outer shield, is used as the signal return, while in others, connector pins are used as signal returns. Various combinations of signal pins, ground blades, and shields can also be utilized. Electrical performance can vary significantly depending upon the number and location of ground pins.

In general, the more pins dedicated to ground, the better electrical performance will be. However, dedicating pins to ground reduces signal density of a connector. Therefore, care must be taken when choosing signal/ground ratios in cost or density-sensitive applications.

Series: QTH/QSH

Description: High Speed Ground Plane Header, 0.5mm (.0197") Pitch, 25mm (.984") Stack Height

For this connector, the following array configurations are evaluated:

Single-Ended Impedance:

- GSG (ground-signal-ground)

Single-Ended Crosstalk:

- Electrical "worst case": GAQG (ground-active-quiet-ground)
- Electrical "best case": GAGQG (ground-active-ground-quiet-ground)
- Across row: "xrow case": GAG to GQG (from one row of terminals to the other

row)

Differential Impedance:

- GSSG (Ground-positive signal-negative signal-ground)

Differential Crosstalk:

- Electrical "worst case": GAAQQG (ground-active-active-quiet-quiet-ground)
- Electrical "best case": GAAGQQG (ground-active-active-ground-quiet-quiet-

ground)

- Across row: "xrow case": GAAG to GQQG (from one row of terminals to the other row)

Only one single-ended signal or differential pair was driven for crosstalk measurements.

Other configurations can be evaluated upon request. Please contact sig@samtec.com for more information.

In a real system environment, active signals might be located at the outer edges of the signal contacts of concern, as opposed to the ground signals utilized in laboratory testing. For example, in a single-ended system, a pin-out of "SSSS", or four adjacent single ended signals might be encountered as opposed to the "GSG" and "GSSG" configurations tested in the laboratory. Electrical characteristics in such applications could vary slightly from laboratory results. However, in most applications, performance can safely be considered equivalent.

Signal Edge Speed (Rise Time):

In pulse signaling applications, the perceived performance of the interconnect can vary significantly depending on the edge rate or rise time of the exciting signal. For this report, the fastest rise time used was 30 ps. Generally, this should demonstrate worst-case performance.

In many systems, the signal edge rate will be significantly slower at the connector than at the driver launch point. To estimate interconnect performance at other edge rates, data is provided for several rise times between 30ps and 500ps.

For this report, measured rise times were at 10%-90% signal levels.

Series: QTH/QSH

Description: High Speed Ground Plane Header, 0.5mm (.0197") Pitch, 25mm (.984") Stack Height

Frequency Domain Data

Frequency Domain parameters are helpful in evaluating the connector system's signal loss and crosstalk characteristics across a range of sinusoidal frequencies. In this report, parameters presented in the Frequency Domain are Insertion Loss, Return Loss, and Near-End and Far-End Crosstalk. Other parameters or formats, such as VSWR or S-Parameters, may be available upon request. Please contact our Signal Integrity Group at sig@samtec.com for more information.

Frequency performance characteristics for the SUT are generated directly from network analyzer measurements.

Time Domain Data

Time Domain parameters indicate Impedance mismatch versus length, signal propagation time, and crosstalk in a pulsed signal environment. The measured S-Parameters from the network analyzer are post-processed using Agilent Advanced Design System to obtain the time domain response. Time Domain procedure is provided in [Appendix E](#) of this report. Parameters or formats not included in this report may be available upon request. Please contact our Signal Integrity Group at sig@samtec.com for more information.

In this report, propagation delay is defined as the signal propagation time through the connector and connector footprint. It includes 10 mils of PCB trace on the QTH connector side and 10 mils of PCB trace on the QSH connector side. Delay is measured at 30 picoseconds signal rise-time. Delay is calculated as the difference in time measured between the 50% amplitude levels of the input and output pulses.

Crosstalk or coupled noise data is provided for various signal configurations. All measurements are single disturber. Crosstalk is calculated as a ratio of the input line voltage to the coupled line voltage. The input line is sometimes described as the active or drive line. The coupled line is sometimes described as the quiet or victim line. Crosstalk ratio is tabulated in this report as a percentage. Measurements are made at both the near-end and far-end of the SUT.

Data for other configurations may be available. Please contact our Signal Integrity Group at sig@samtec.com for further information.

As a rule of thumb, 10% crosstalk levels are often used as a general first pass limit for determining acceptable interconnect performance. However, modern system crosstalk tolerance can vary greatly. For advice on connector suitability for specific applications, please contact our Signal Integrity Group at sig@samtec.com.



Series: QTH/QSH

Description: High Speed Ground Plane Header, 0.5mm (.0197") Pitch, 25mm (.984") Stack Height

Additional information concerning test conditions and procedures is located in the appendices of this report. Further information may be obtained by contacting our Signal Integrity Group at sig@samtec.com.

Series: QTH/QSH

Description: High Speed Ground Plane Header, 0.5mm (.0197") Pitch, 25mm (.984") Stack Height

Appendix A – Frequency Domain Response Graphs

Single-Ended Application – Insertion Loss

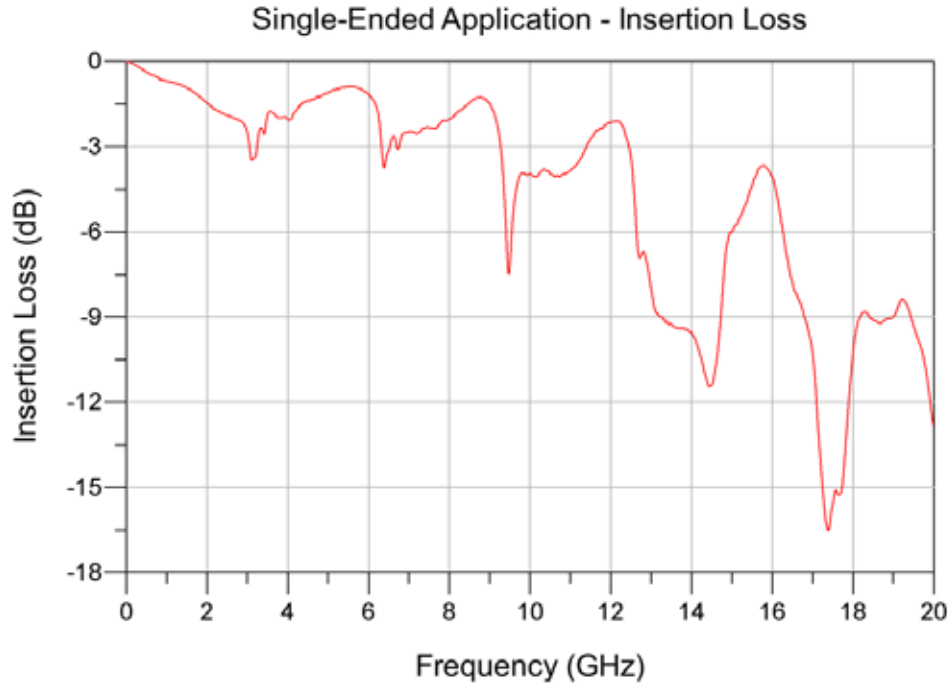

Single-Ended Application – Return Loss

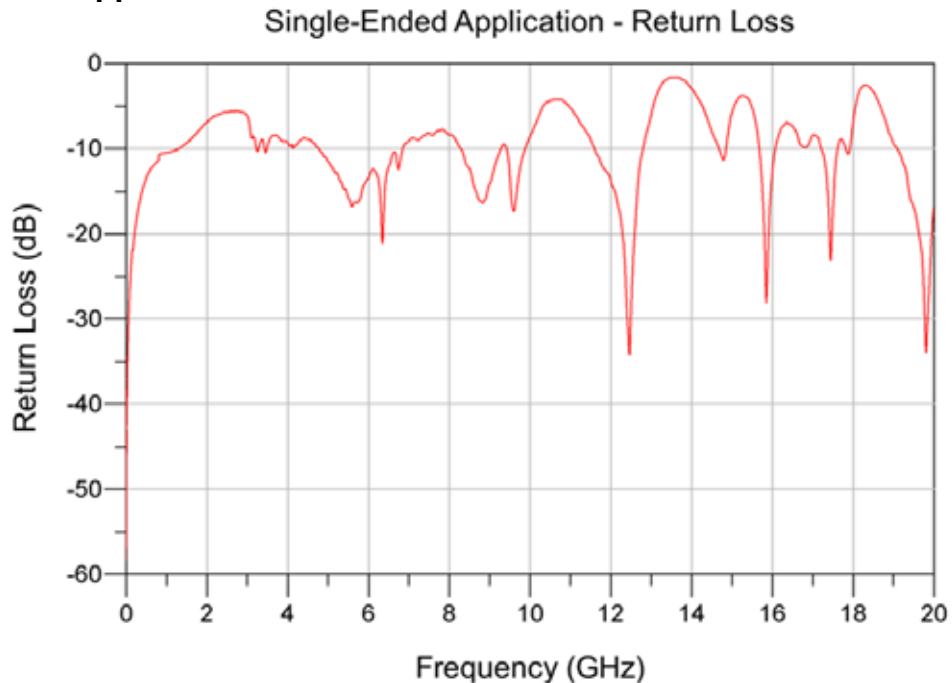

Series: QTH/QSH

Description: High Speed Ground Plane Header, 0.5mm (.0197") Pitch, 25mm (.984") Stack Height

Single-Ended Application – NEXT Configurations

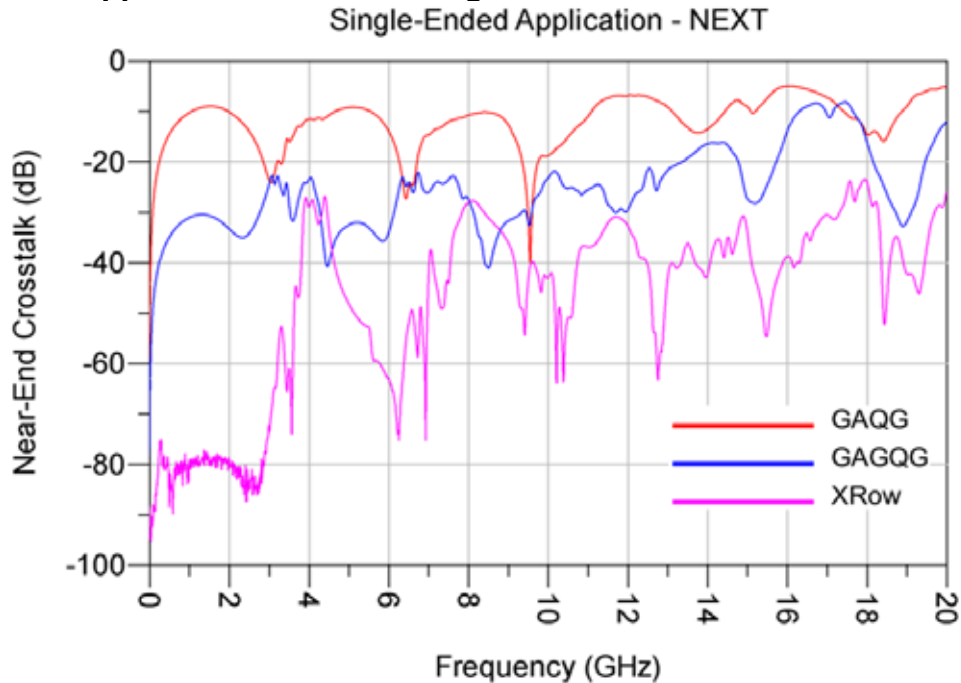

Single-Ended Application – FEXT Configurations

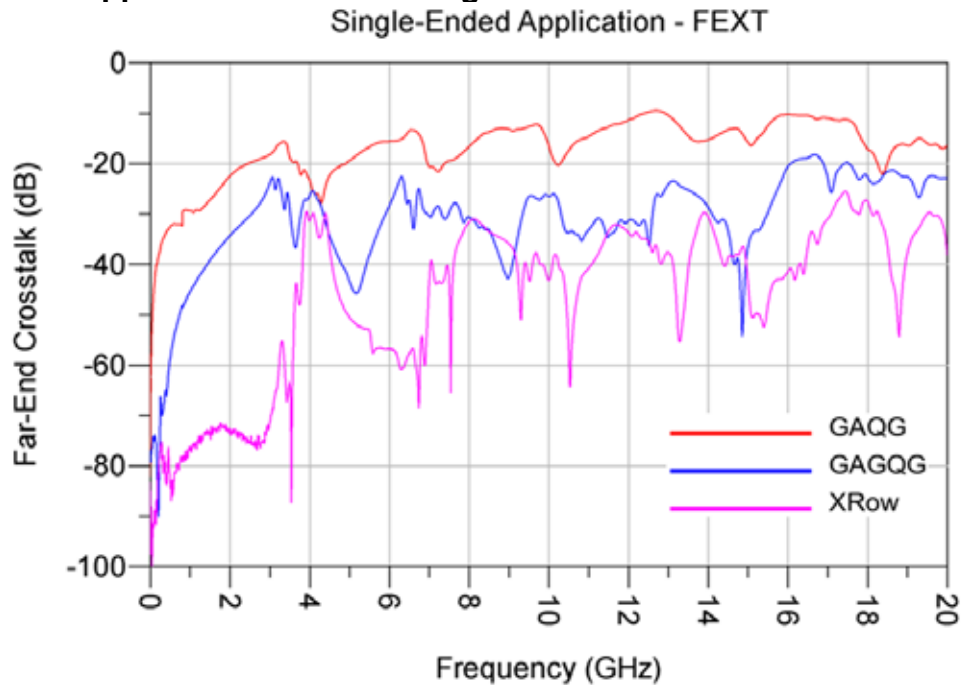

Series: QTH/QSH

Description: High Speed Ground Plane Header, 0.5mm (.0197") Pitch, 25mm (.984") Stack Height

Differential Application – Insertion Loss

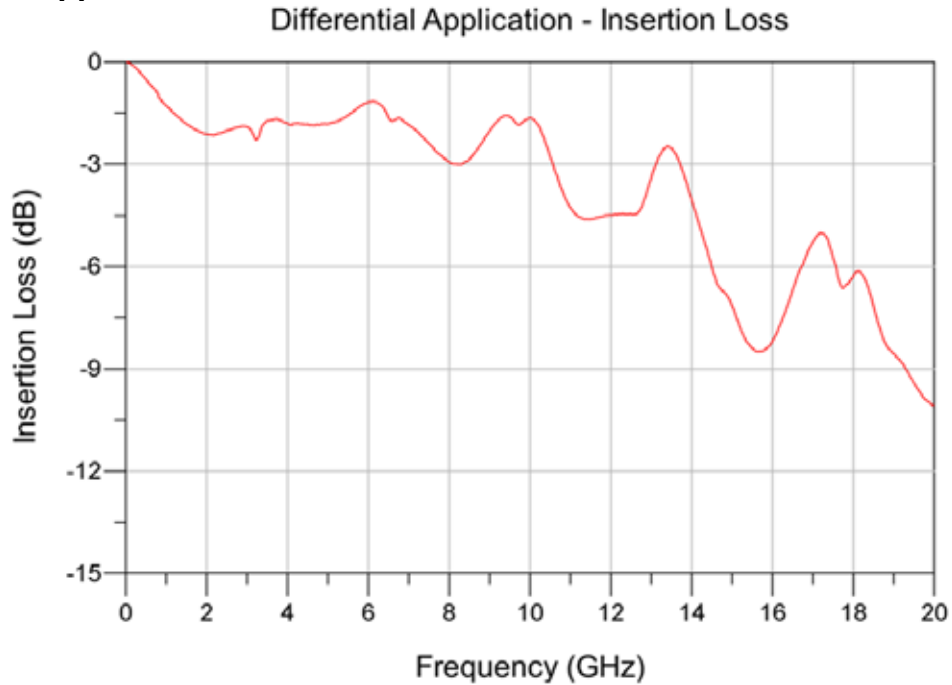

Differential Application – Return Loss

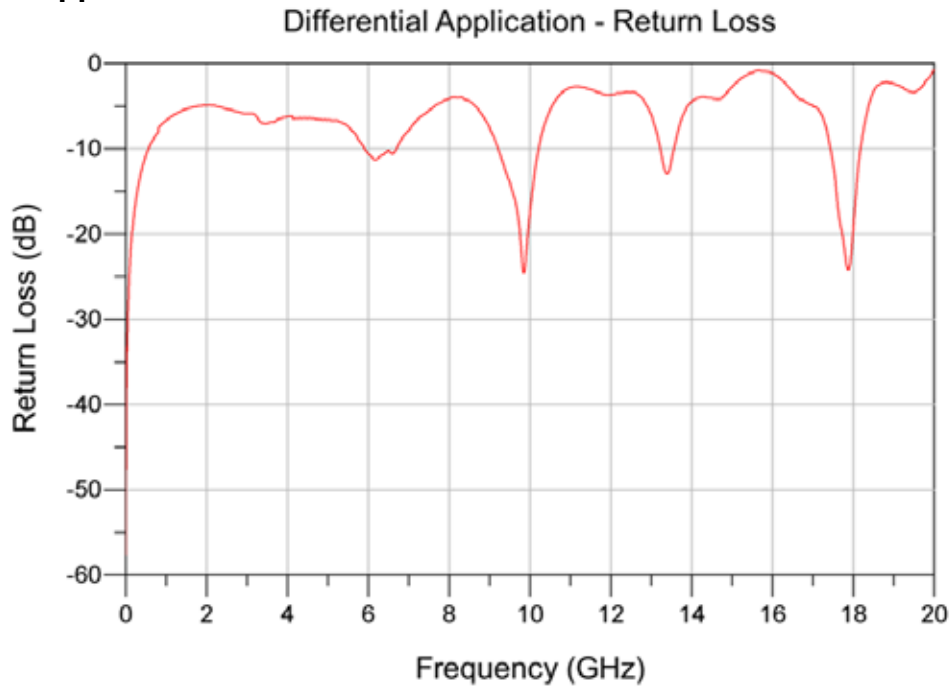

Series: QTH/QSH

Description: High Speed Ground Plane Header, 0.5mm (.0197") Pitch, 25mm (.984") Stack Height

Differential Application – NEXT Configurations

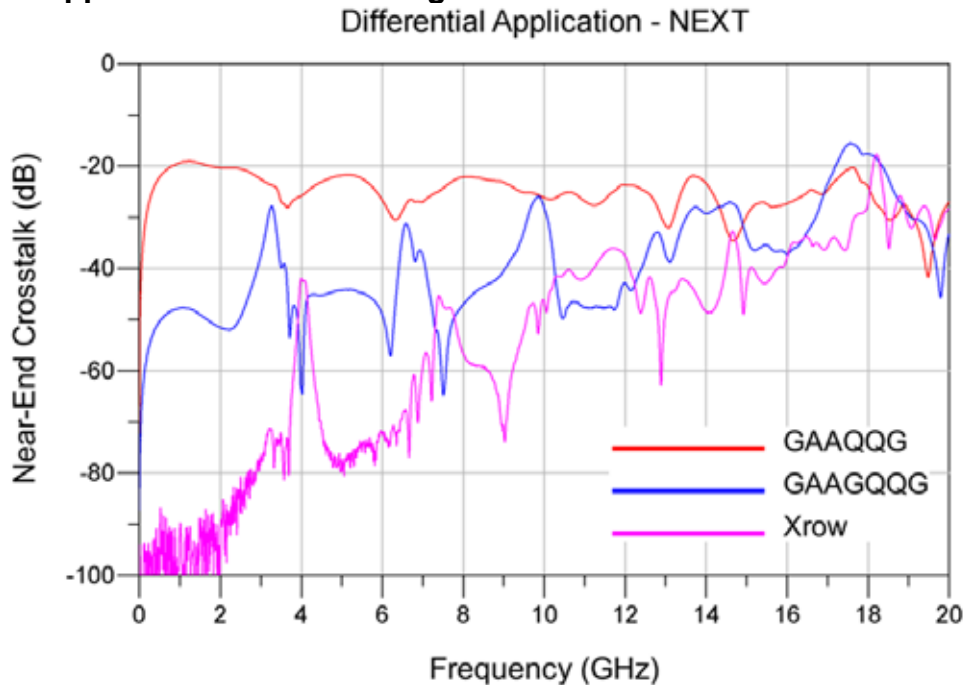

Differential Application – FEXT Configurations

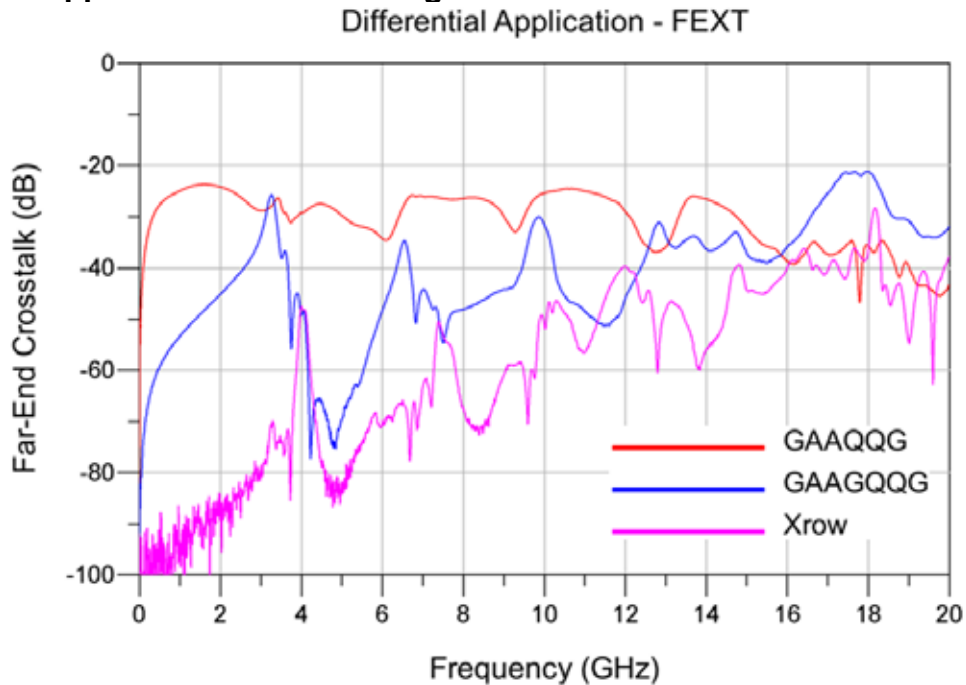

Series: QTH/QSH

Description: High Speed Ground Plane Header, 0.5mm (.0197") Pitch, 25mm (.984") Stack Height

Appendix B – Time Domain Response Graphs

Single-Ended Application – Input Pulse

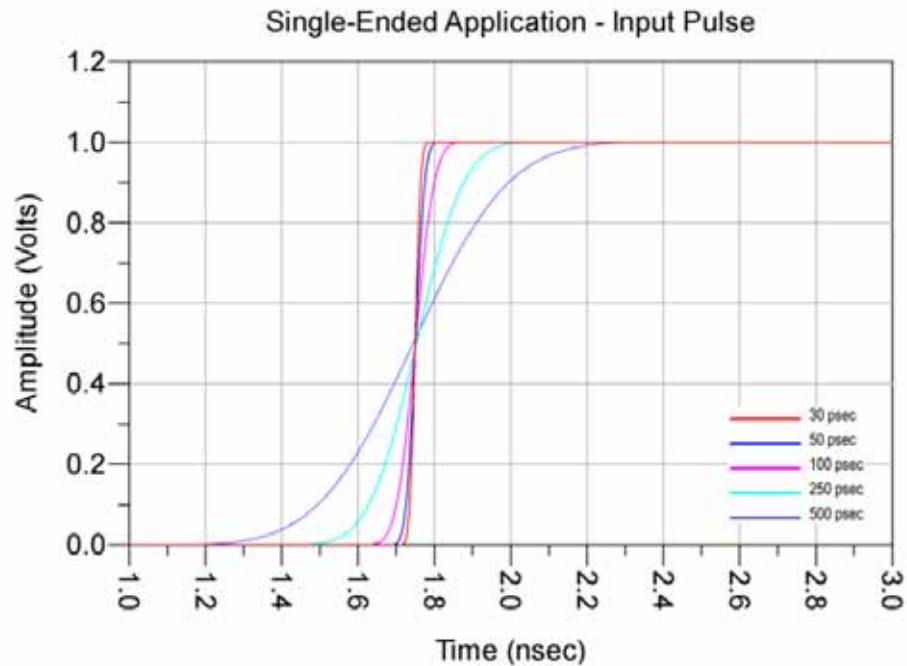

Series: QTH/QSH

Description: High Speed Ground Plane Header, 0.5mm (.0197") Pitch, 25mm (.984") Stack Height

Single-Ended Application – Impedance

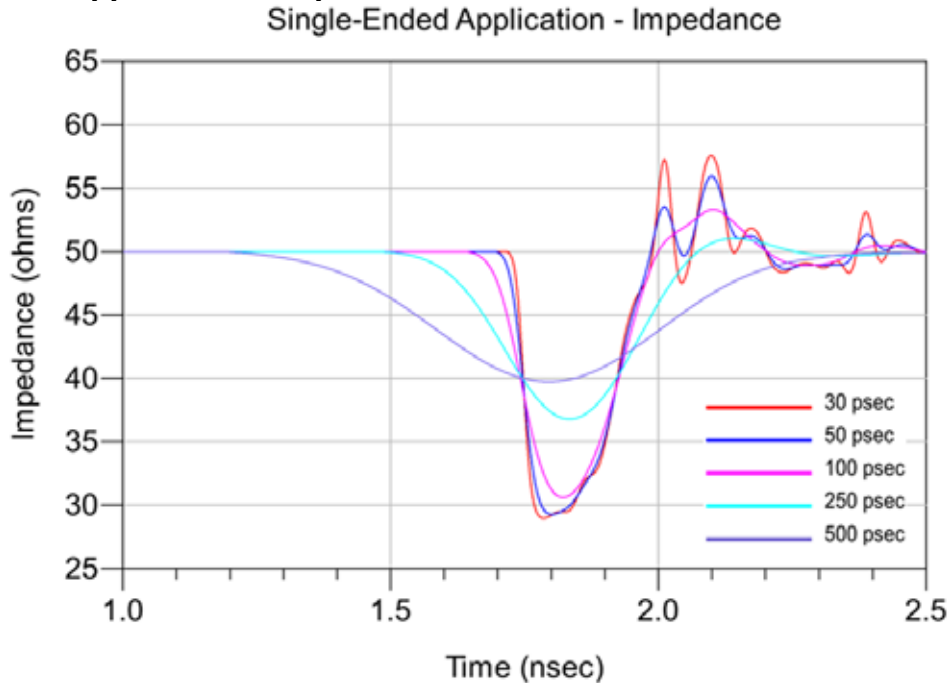

Single-Ended Application – Propagation Delay

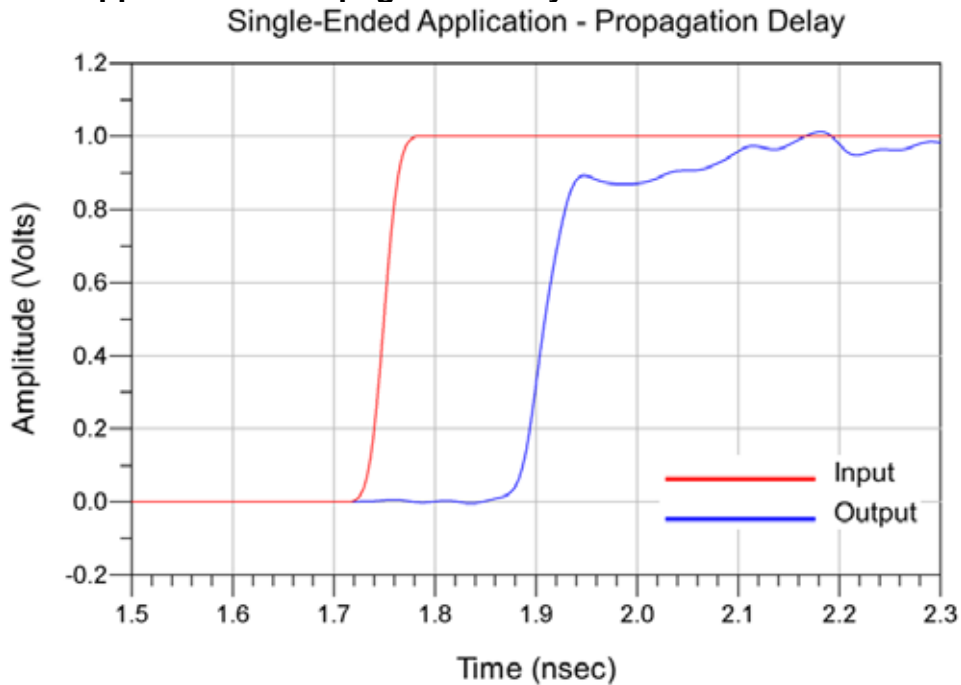

Series: QTH/QSH

Description: High Speed Ground Plane Header, 0.5mm (.0197") Pitch, 25mm (.984") Stack Height

Single-Ended Application – NEXT, Worst Case Configuration

Single-Ended Application - NEXT



Single-Ended Application – FEXT, Worst Case Configuration

Single-Ended Application - FEXT

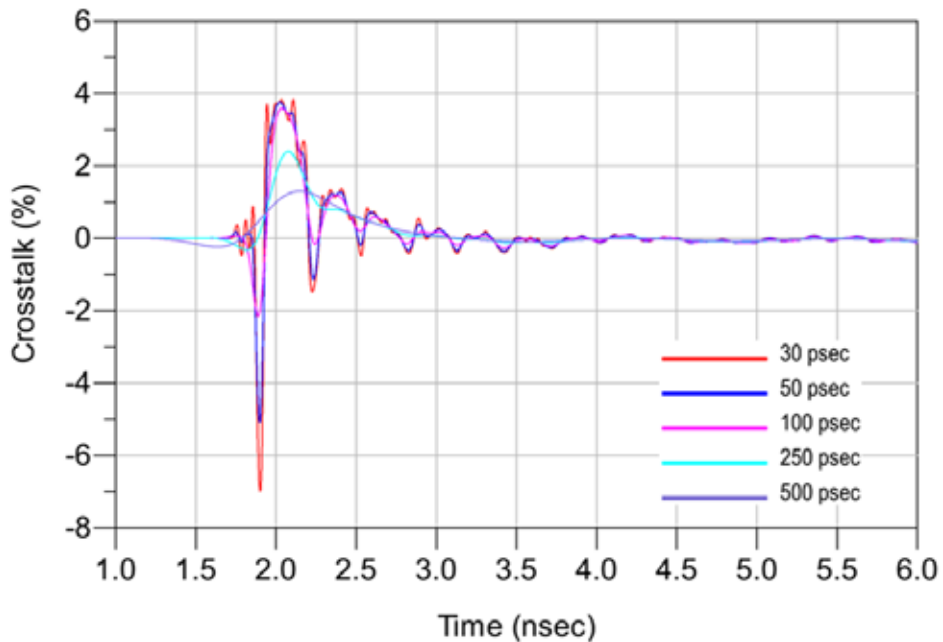

Series: QTH/QSH

Description: High Speed Ground Plane Header, 0.5mm (.0197") Pitch, 25mm (.984") Stack Height

Single-Ended Application – NEXT, Best Case Configuration

Single-Ended Application - NEXT

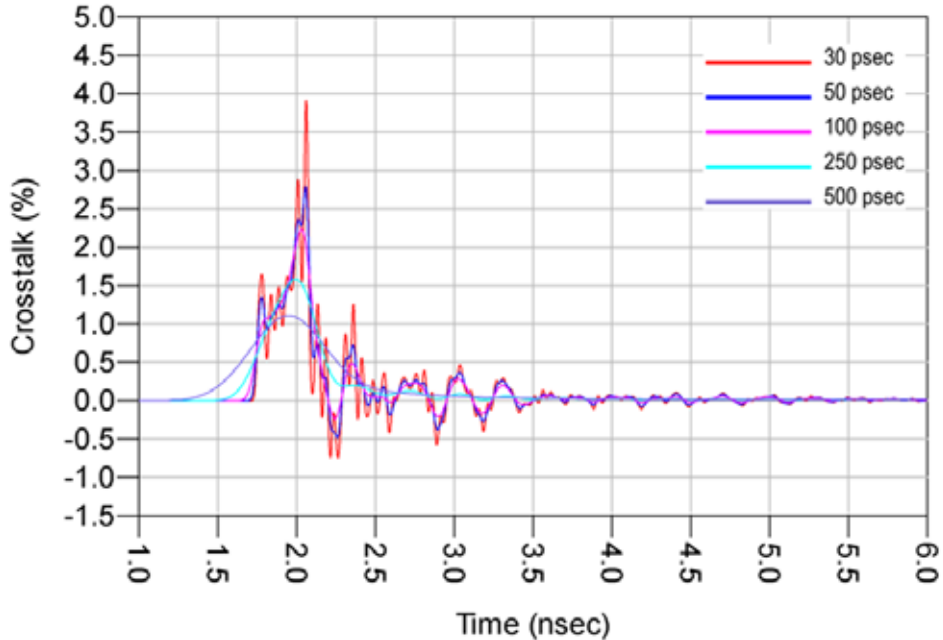

Single-Ended Application – FEXT, Best Case Configuration

Single-Ended Application - FEXT

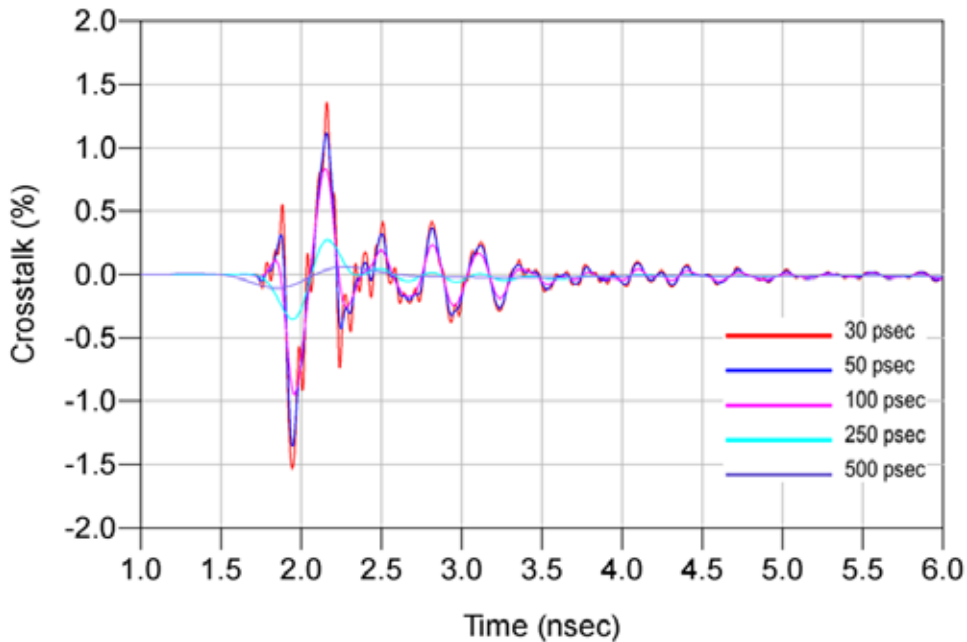

Series: QTH/QSH

Description: High Speed Ground Plane Header, 0.5mm (.0197") Pitch, 25mm (.984") Stack Height

Single-Ended Application – NEXT, Across Row Configuration

Single-Ended Application - NEXT

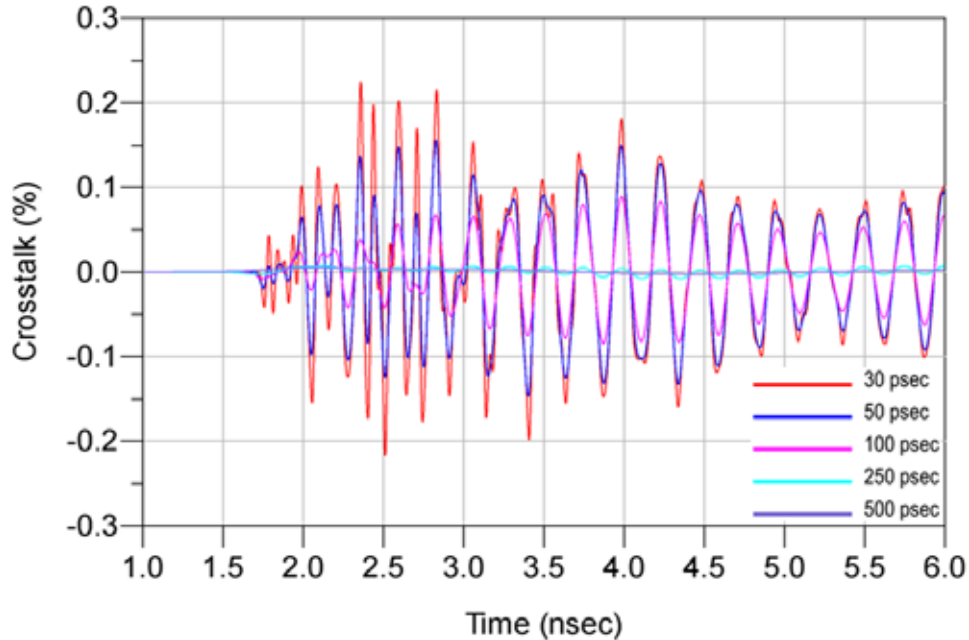

Single-Ended Application – FEXT, Across Row Configuration

Single-Ended Application - FEXT

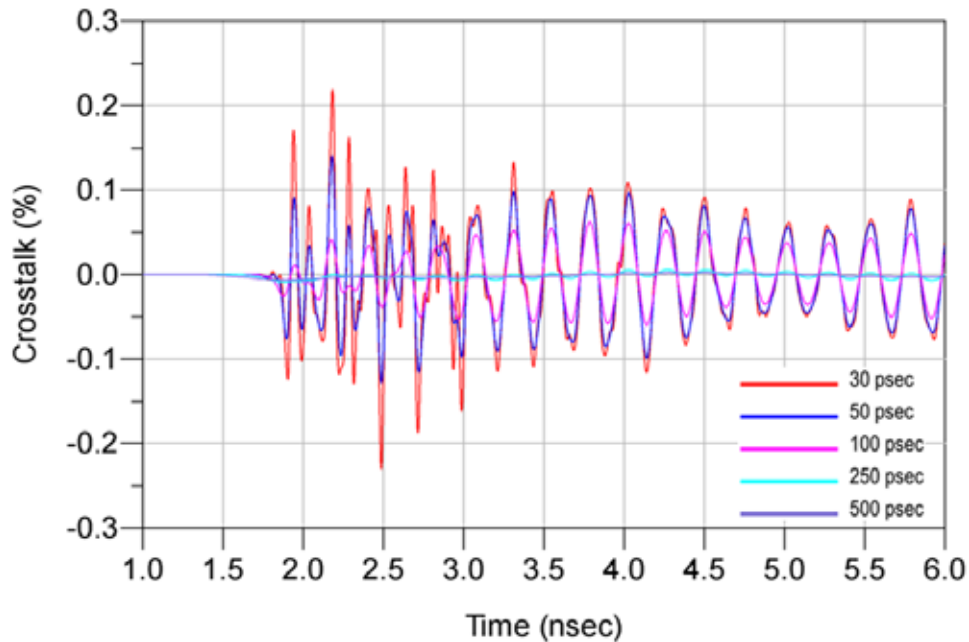

Series: QTH/QSH

Description: High Speed Ground Plane Header, 0.5mm (.0197") Pitch, 25mm (.984") Stack Height

Differential Application – Input Pulse

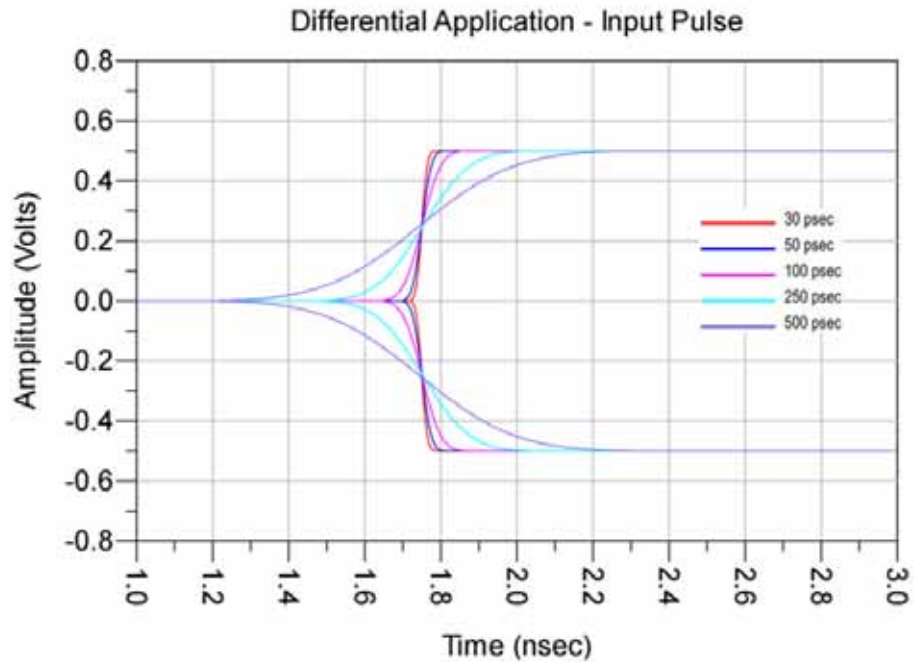

Series: QTH/QSH

Description: High Speed Ground Plane Header, 0.5mm (.0197") Pitch, 25mm (.984") Stack Height

Differential Application – Impedance

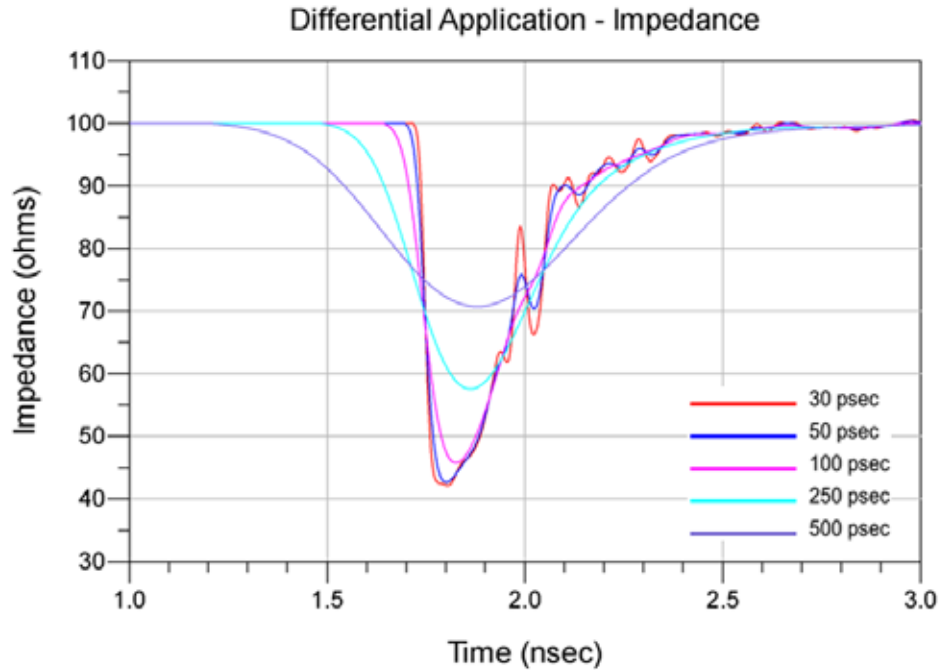

Differential Application – Propagation Delay

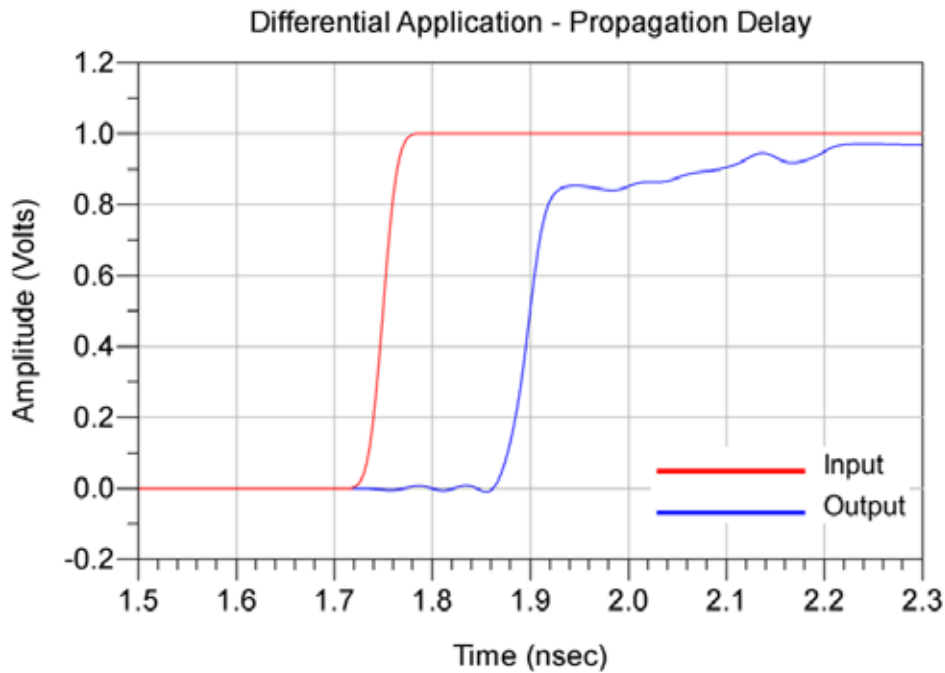

Series: QTH/QSH

Description: High Speed Ground Plane Header, 0.5mm (.0197") Pitch, 25mm (.984") Stack Height

Differential Application – NEXT, Worst Case Configuration

Differential Application - NEXT

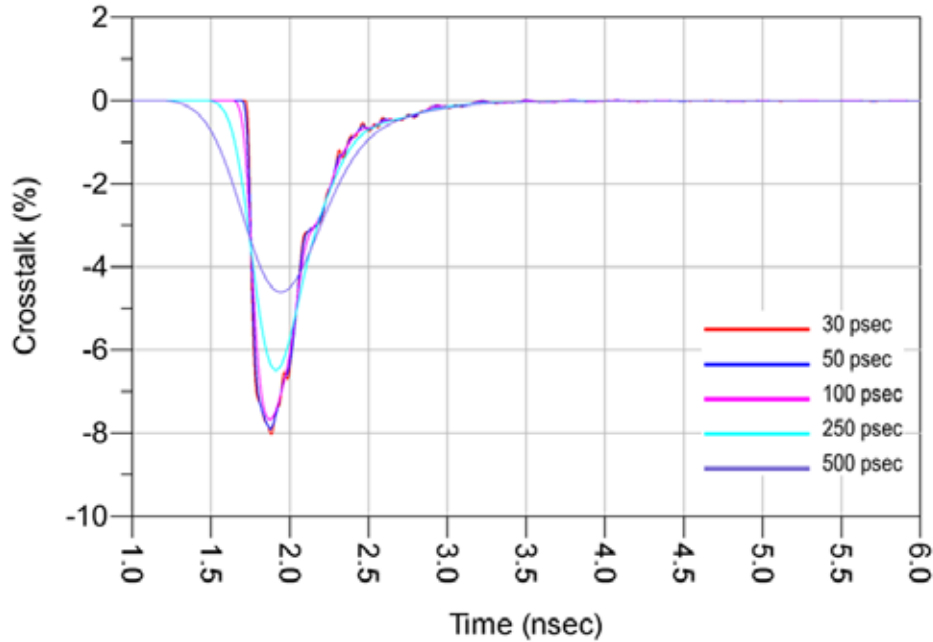

Differential Application – FEXT, Worst Case Configuration

Differential Application - FEXT

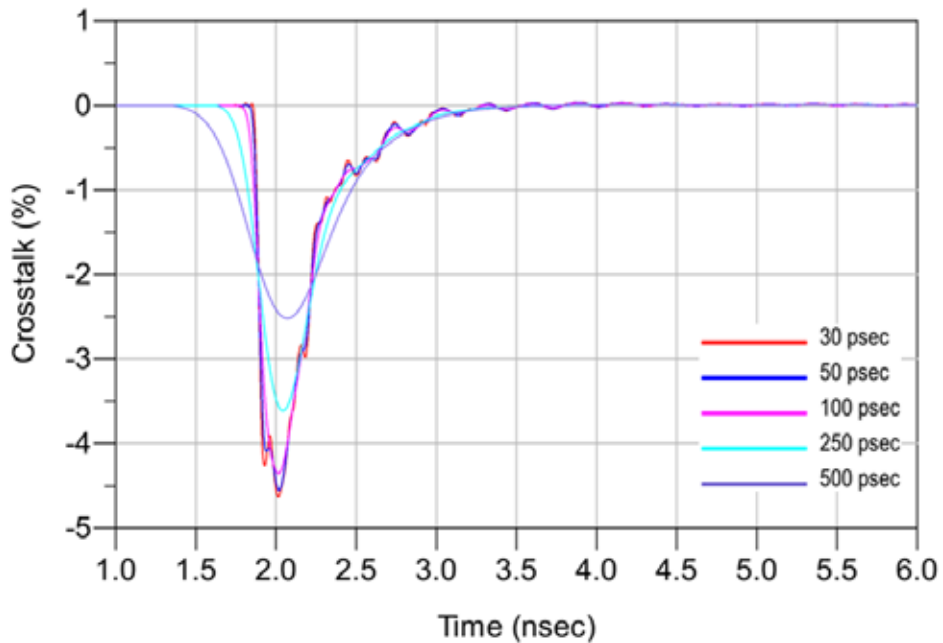

Series: QTH/QSH

Description: High Speed Ground Plane Header, 0.5mm (.0197") Pitch, 25mm (.984") Stack Height

Differential Application – NEXT, Best Case Configuration

Differential Application - NEXT

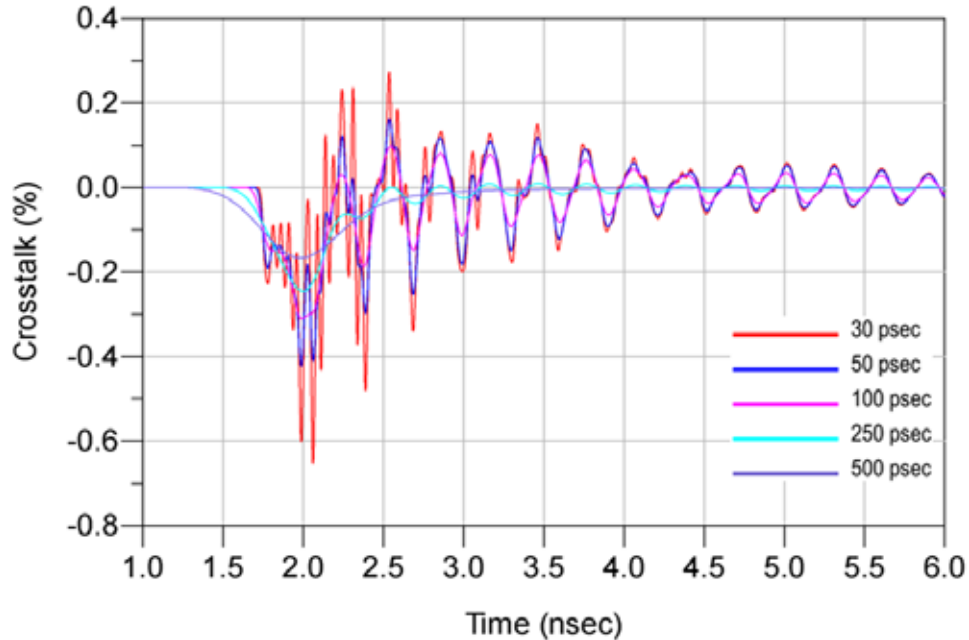

Differential Application – FEXT, Best Case Configuration

Differential Application - FEXT

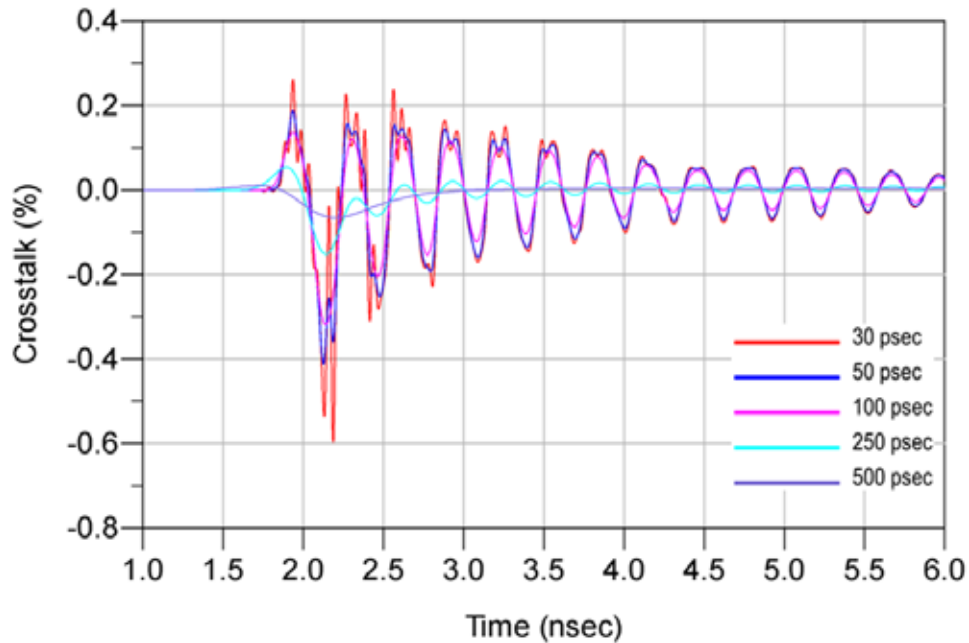

Series: QTH/QSH

Description: High Speed Ground Plane Header, 0.5mm (.0197") Pitch, 25mm (.984") Stack Height

Differential Application – NEXT, Across Row Case Configuration

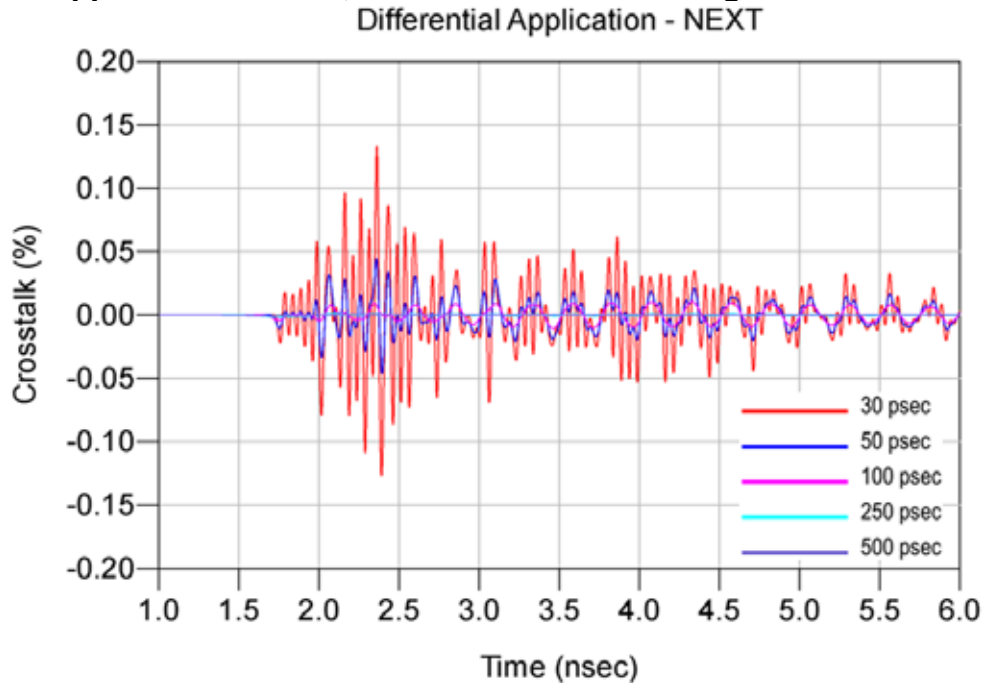

Differential Application – FEXT, Across Row Case Configuration

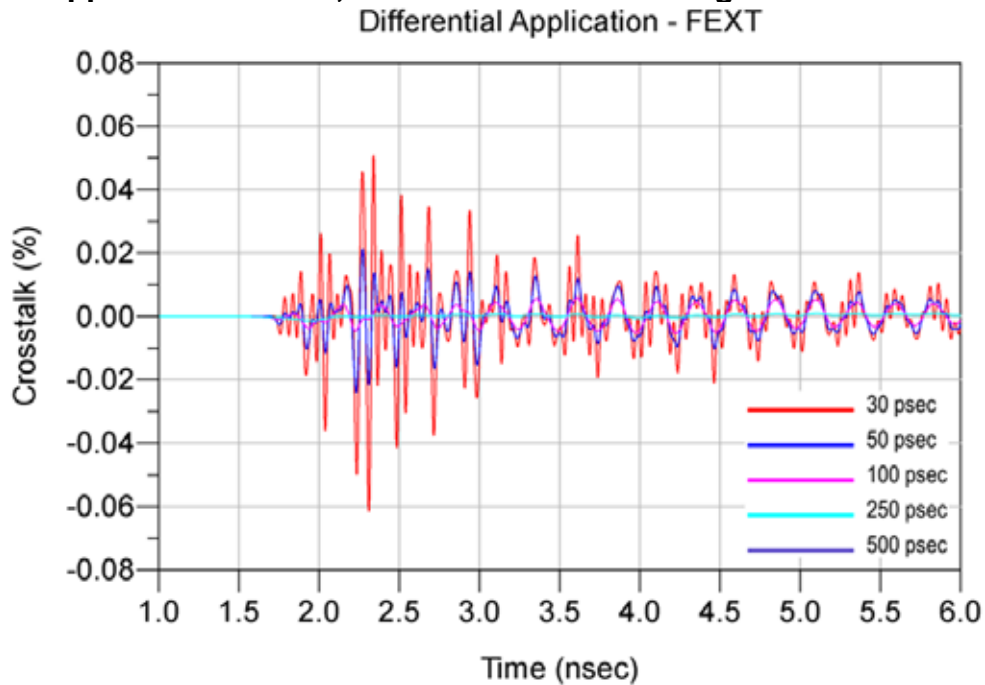

Series: QTH/QSH

Description: High Speed Ground Plane Header, 0.5mm (.0197") Pitch, 25mm (.984") Stack Height

Appendix C – Product and Test System Descriptions

Product Description

Product test samples are QTH/QSH High Speed Ground Plane Header. The part number is QTH-030-07-L-D-A and it mates to QSH-030-01-L-D-A. The connector has two rows of 30 contacts evenly spaced on a 0.5 mm (0.0197") pitch. A photo of the mated test article mounted to SI test boards is shown at right.

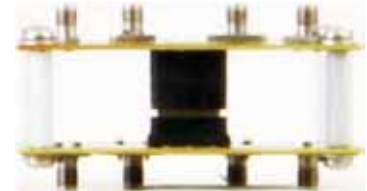

Test System Description

The test fixtures are composed of four-layer FR-406 material with 50Ω signal trace and pad configurations designed for the electrical characterization of Samtec high speed connector products. A PCB mount SMA connector is used to interface the VNA test cables to the test fixtures. SMA launch optimization is attained using full wave simulation tools to minimize reflections. There are 11 test fixtures specific to the QTH/QSH series connector set. Ten of the 11 fixtures mate to comprise a full hi-speed characterization test. The remaining board contains the SMA/LRM calibration structures designed specifically for the QTH/QSH series. Displayed on the following pages is information for the SMA/LRM calibration structure and directives for mating QTH/QSH fixtures.

PCB-103842-TST-XX Test Fixtures



Series: QTH/QSH

Description: High Speed Ground Plane Header, 0.5mm (.0197") Pitch, 25mm (.984") Stack Height

PCB-103842-TST-XX PCB Layout Panel

PCB design artwork shown below.

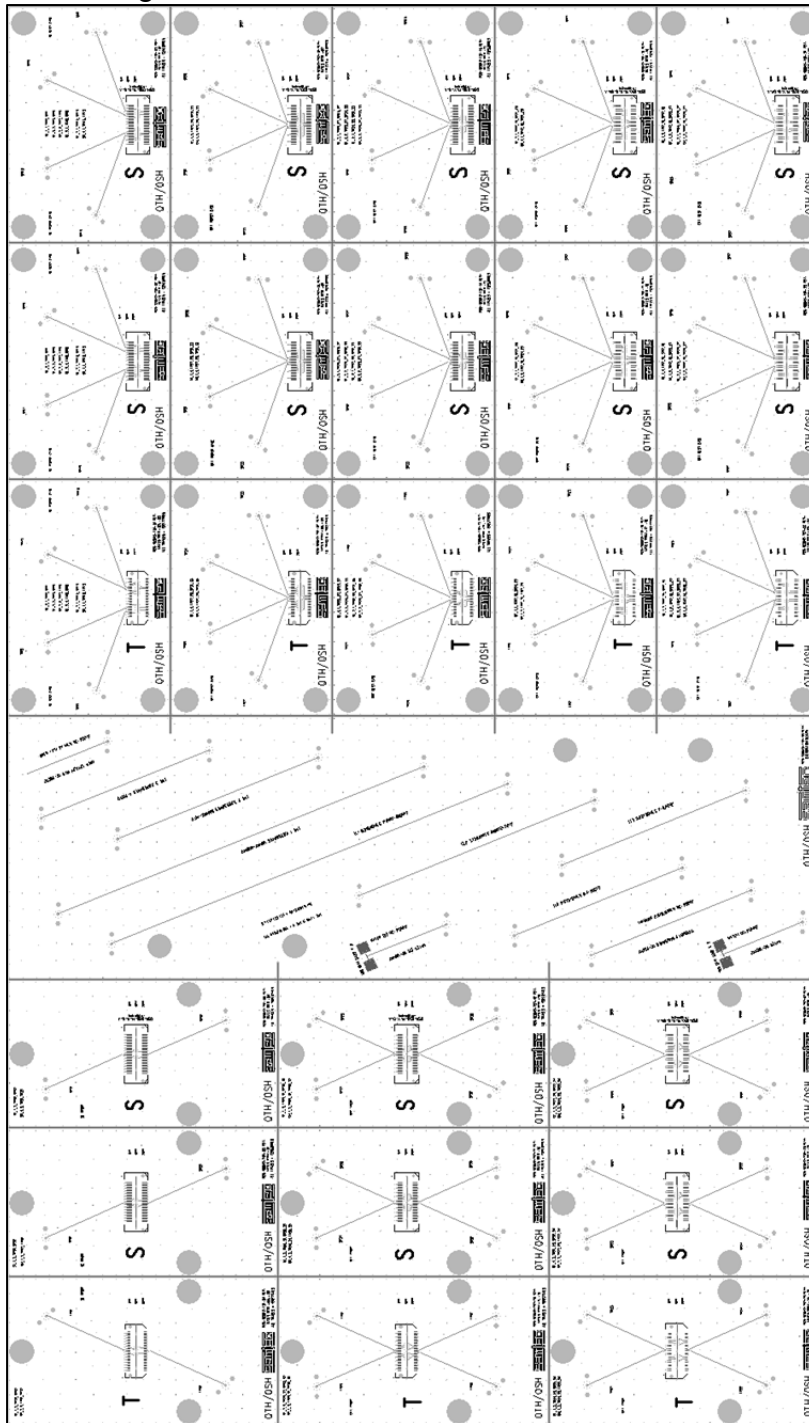

Series: QTH/QSH

Description: High Speed Ground Plane Header, 0.5mm (.0197") Pitch, 25mm (.984") Stack Height

PCB Fixtures

The test fixtures used are as follows:

PCB-103842 -TST-01 Rev - QTH/QSH Hi-Speed SMA Test Board *mates with* PCB-103842 -TST-02 Rev - QTH/QSH Hi-Speed SMA Test Board Single-Ended Best & Worst Case Configurations. Transmission/ Reflection Parameters, Crosstalk Parameters

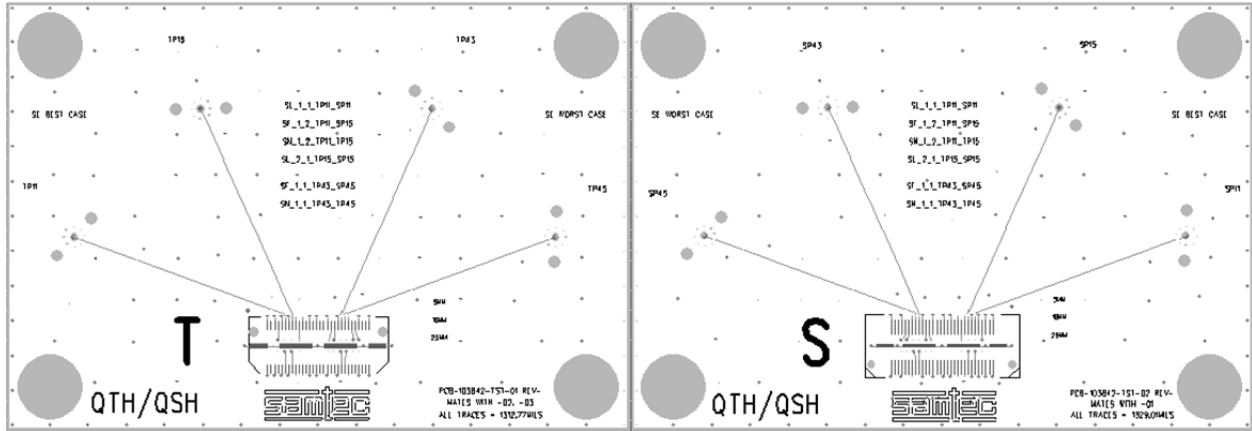

PCB-103842 -TST-04 Rev - QTH/QSH Hi-Speed SMA Test Board *mates with* PCB-103842 -TST-05 Rev - QTH/QSH Hi-Speed SMA Test Board Single Ended Cross Row Configurations. Crosstalk Parameters

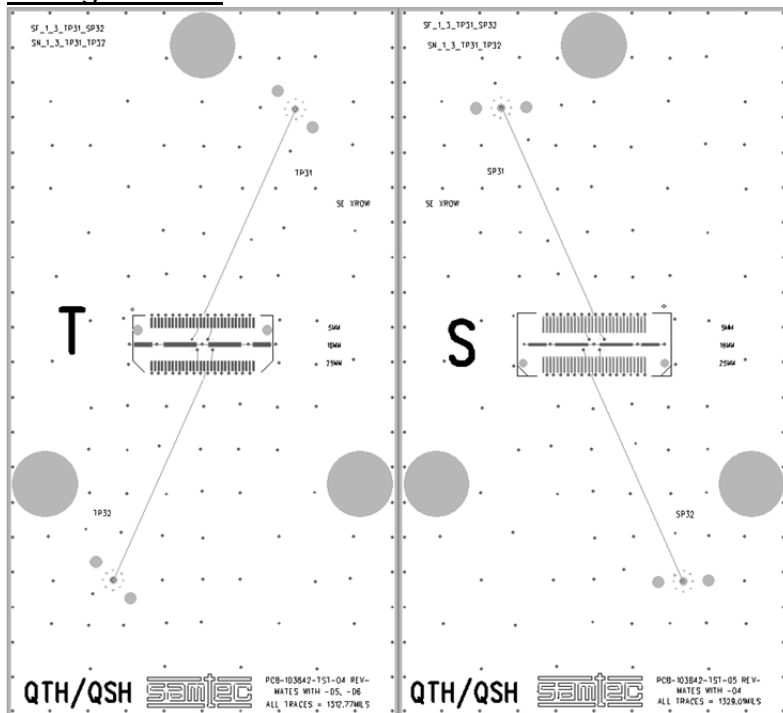

Series: QTH/QSH

Description: High Speed Ground Plane Header, 0.5mm (.0197") Pitch, 25mm (.984") Stack Height

PCB Fixtures (Cont.)

PCB-103842 -TST-07 Rev - QTH/QSH Hi-Speed SMA Test Board *mates with PCB-103842 -TST-08 Rev - QTH/QSH Hi-Speed SMA Test Board* Differential Worst Case Configurations. Crosstalk Parameters

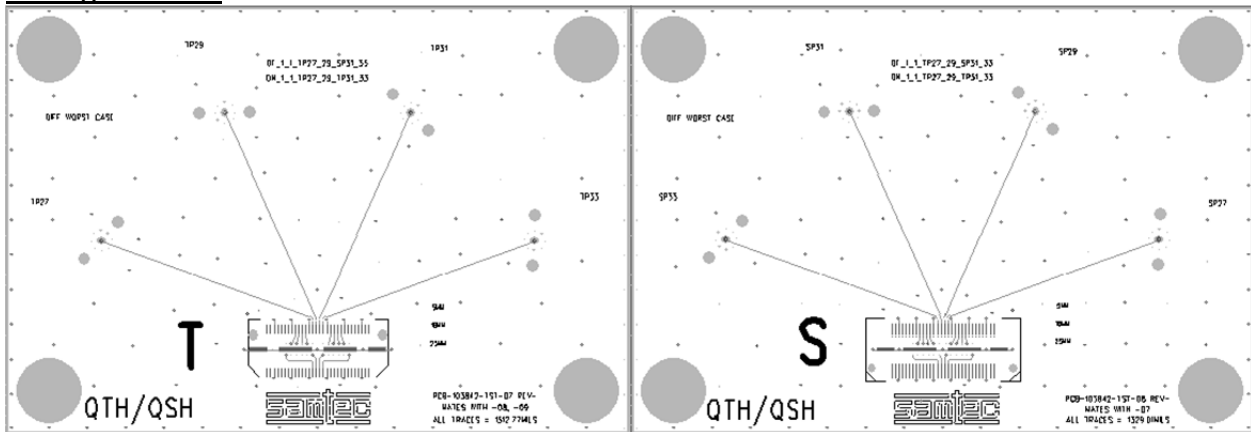

PCB-103842 -TST-13 Rev - QTH/QSH Hi-Speed SMA Test Board *mates with PCB-103842 -TST-14 Rev - QTH/QSH Hi-Speed SMA Test Board* Differential Best Case Configurations. Transmission/Reflection Parameters, Crosstalk Parameters

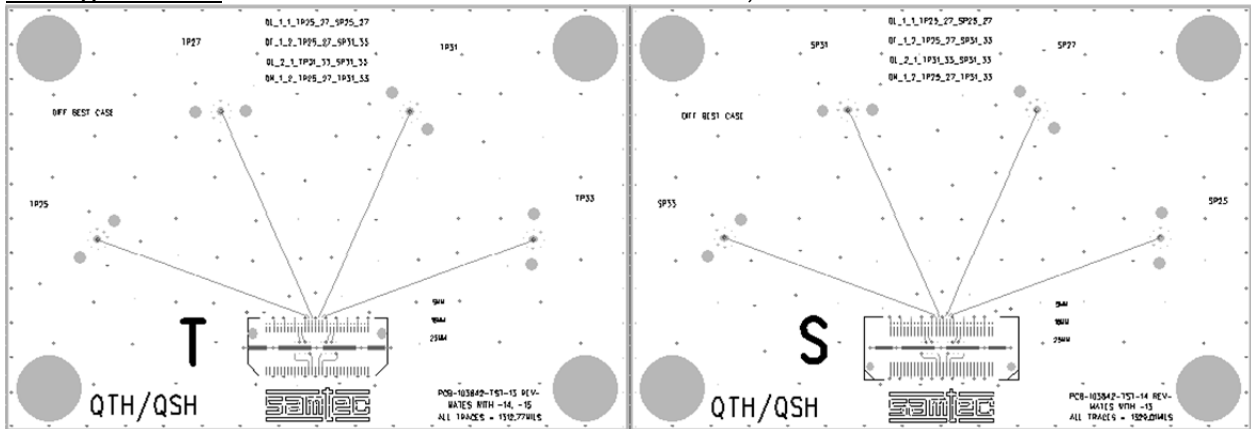

Series: QTH/QSH

Description: High Speed Ground Plane Header, 0.5mm (.0197") Pitch, 25mm (.984") Stack Height

PCB Fixtures (Cont.)

PCB-103842 -TST-10 Rev - QTH/QSH Hi-Speed SMA Test Board *mates with* PCB-103842 -TST-11 Rev - QTH/QSH Hi-Speed SMA Test Board Differential Cross Row Configurations. Crosstalk Parameters

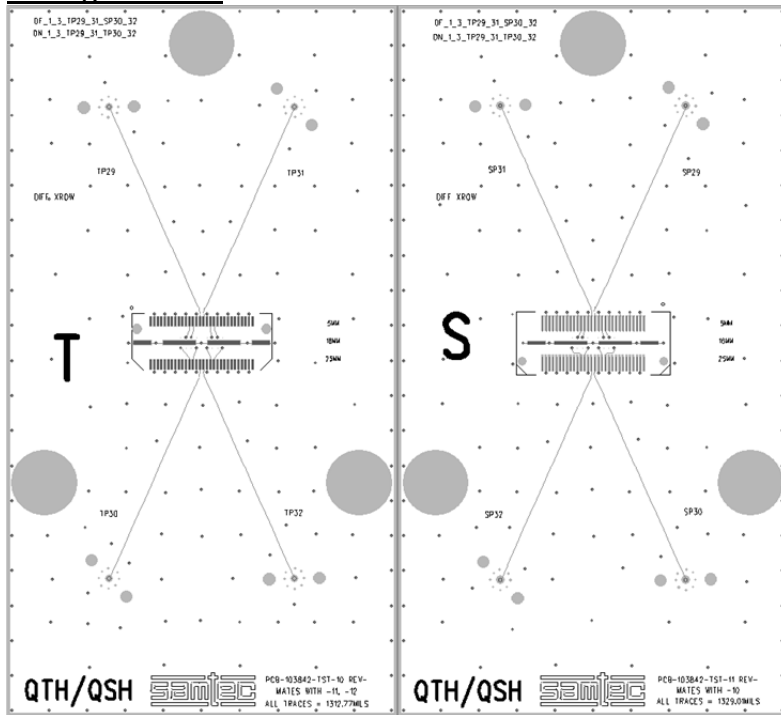

Calibration Board

Test fixture losses and test point reflections were removed from the data by use of LRM calibration. The calibration boards are shown below. Prior to making any measurements, the calibration board is characterized to obtain parameters required to define the calibration kit. Once a cal kit is defined, calibration using the standards on the calibration board can be performed. Finally, the device can be measured and the test board effects are automatically removed.

Series: QTH/QSH

Description: High Speed Ground Plane Header, 0.5mm (.0197") Pitch, 25mm (.984") Stack Height

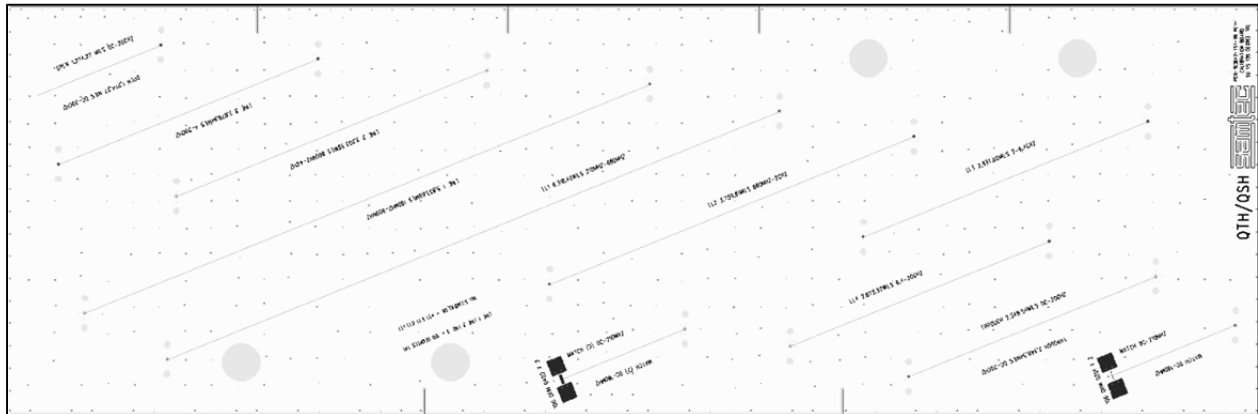

Line - Reflect - Match (LRM) Calibration Standards

PCB-103842-TST-99

Line 1 - Length = 5833.66 mils

Line 2 - Length = 3205.56 mils

Line 3 - Length = 2679.94 mils

Thru Line (2X) = 2548.54 mils

Reflect Standard - Length = 1274.27 mils

Match Standard - Length = 1274.27 mils

*Note: additional structures present on calibration board are for a different experiment

Series: QTH/QSH

Description: High Speed Ground Plane Header, 0.5mm (.0197") Pitch, 25mm (.984") Stack Height

All traces on the QTH test boards are length matched to 1312.77 mils measured from the center of the signal pad to the SMA center contact pad. All traces on the QSH test boards are length matched to 1329.01 mils measured from the center of the signal pad to the SMA center contact pad. The LRM calibration effectively removes 1274.27 mils of PCB signal trace effects. Since the footprint geometry is 16.25 mils longer on the QSH connector, the reference plane location is an equal distance from the edge of the connectors signal pads. The calibrated reference plane is located 10 mils from the connector pad on each side. The S-Parameter measurements include:

- A. The QTH Series connector
- B. Test board vias, pads (footprint effects) for the QTH connector side.
- C. 10 mils of 9.5 mil wide microstrip signal trace
- D. The QSH Series connector
- E. Test board vias, pads (footprint effects) for the QSH connector side.
- F. 10 mils of 9.5 mil wide microstrip signal trace

The figure below shows the location of the measurement reference plane.

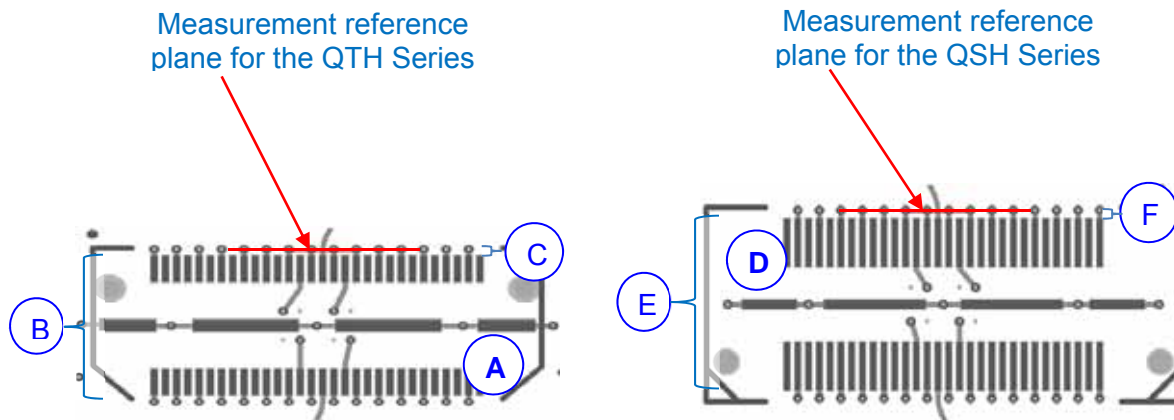

Series: QTH/QSH

Description: High Speed Ground Plane Header, 0.5mm (.0197") Pitch, 25mm (.984") Stack Height

Appendix D – Test and Measurement Setup

The test instrument is the Agilent N5230C PNA-L network analyzer. Frequency domain data and graphs are obtained directly from the instrument. Post-processed time domain data and graphs are generated using convolution algorithms within Agilent ADS. The network analyzer is configured as follows:

Start Frequency – 300 KHz Number of points -1601
Stop Frequency – 20 GHz IFBW – 1 KHz

With these settings, the measurement time is approximately 20 seconds.

N5230C Measurement Setup

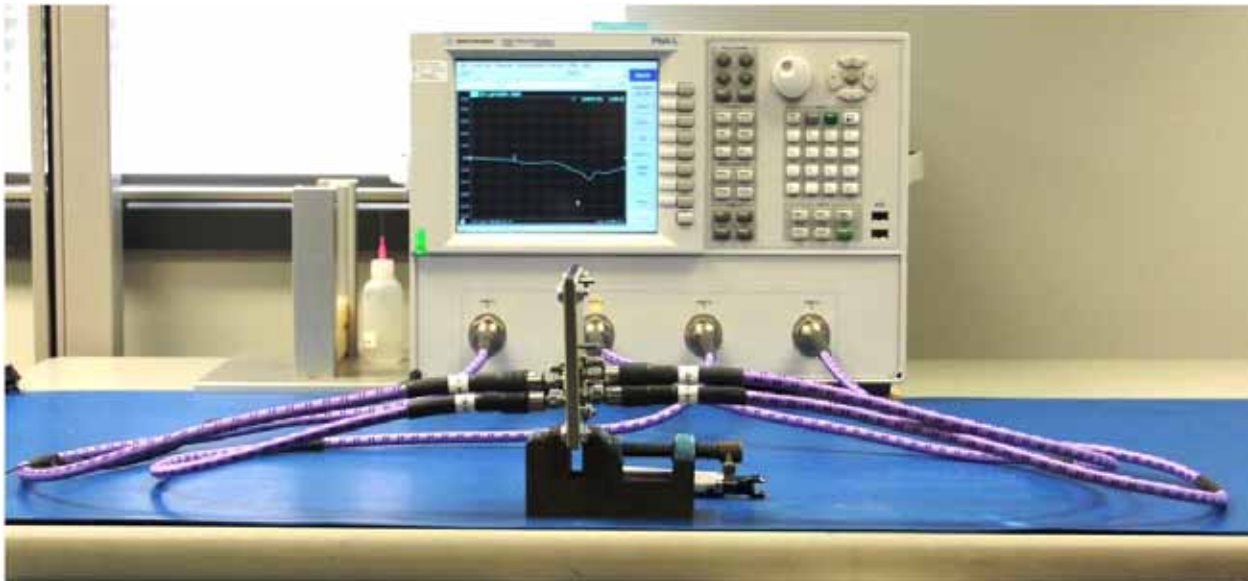

Test Instruments

<u>QTY</u>	<u>Description</u>
1	Agilent N5230C PNA-L 4-Port Network Analyzer (300 KHz to 20 GHz)
1	Agilent N4433A Ecal module (300 KHz to 20 GHz)

Test Cables & Adapters

<u>QTY</u>	<u>Description</u>
4	WL Gore –Z0CJ0CK0360 3.5 mm(f) to 3.5mm(m) Test Port Cables

Series: QTH/QSH

Description: High Speed Ground Plane Header, 0.5mm (.0197") Pitch, 25mm (.984") Stack Height

Appendix E - Frequency and Time Domain Measurements

Frequency (S-Parameter) Domain Procedures

The quality of any data taken with a network analyzer is directly related to the quality of the calibration standards and the use of proper test procedures. For this reason, extreme care is taken in the design of the LRM calibration standards, the SI test boards, and the selection of the PCB vendor.

The measurement process begins with a measurement of the LRM calibration standards. A coaxial SOLT calibration is performed using an N4433A E-cal module. This measurement is required in order to obtain precise values of the line standard offset delay and frequency bandwidths. Measurements of the reflect and 2x through line standard can be used to determine the maximum frequency for which the calibration standards are valid. For the QTH/QSH Series test boards, this is greater than 20 GHz.

From the LRM calibration standard measurements, a user defined calibration kit is developed and stored in the network analyzer. Calibration is then performed on all 4 ports following the calibration wizard within the Agilent N5230C. This calibration is saved and can be recalled at any time. Calibration takes roughly 30 minutes to perform.

Time Domain Procedures

Mathematically, Frequency Domain data can be transformed to obtain a Time Domain response. Perfect transformation requires Frequency Domain data from DC to infinity Hz. Fortunately, a very accurate Time Domain response can be obtained with bandwidth-limited data, such as measured with modern network analyzer.

The Time Domain responses were generated using Agilent ADS 2011 update 10. This tool has a transient convolution simulator, which can generate a Time Domain response directly from measured S-Parameters. An example of a similar methodology is provided in the Samtec Technical Note on domain transformation.

[http://www.samtec.com/Technical_Library/reference/articles/pdfs/tech-note_using-PLTS-for-time-domain-data_web.pdf](http://www.samtec.com/Technical_Library/reference/articles/pdfs/tech-note_using_PLTS-for-time-domain-data_web.pdf)

Impedance (TDR)

A step pulse is applied to the touchstone model of the connector and the reflected voltage is monitored. The reflected voltage is converted to a reflection coefficient and then transformed into an impedance profile. All ports of the Touchstone model are terminated in 50 ohms.

Series: QTH/QSH

Description: High Speed Ground Plane Header, 0.5mm (.0197") Pitch, 25mm (.984") Stack Height

Propagation Delay (TDT)

The Propagation Delay is a measure of the Time Domain delay through the connector and footprint. A step pulse is applied to the touchstone model of the connector and the transmitted voltage is monitored. The same pulse is also applied to a reference channel with zero loss, and the Time Domain pulses are plotted on the same graph. The difference in time, measured at the 50% point of the step voltage is the propagation delay.

Near-End Crosstalk (TDT) & Far End Crosstalk (TDT)

A step pulse is applied to the touchstone model of the connector and the coupled voltage is monitored. The amplitude of the peak-coupled voltage is recorded and reported as a percentage of the input pulse.

Series: QTH/QSH

Description: High Speed Ground Plane Header, 0.5mm (.0197") Pitch, 25mm (.984") Stack Height

Appendix F – Glossary of Terms

ADS – Advanced Design Systems

BC – Best Case crosstalk configuration

DUT – Device under test, term used for TDA IConnect & Propagation Delay waveforms

FD – Frequency domain

FEXT – Far-End Crosstalk

GSG – Ground–Signal–Ground; geometric configuration

GSSG - Ground–Signal–Signal–Ground; geometric configuration

HDV – High Density Vertical

NEXT – Near-End Crosstalk

OV – Optimal Vertical

OH – Optimal Horizontal

PCB – Printed Circuit Board

PPO – Pin Population Option

SE – Single-Ended

SI – Signal Integrity

SUT – System Under Test

S – Static (independent of PCB ground)

SOLT – acronym used to define Short, Open, Load & Thru Calibration Standards

TD – Time Domain

TDA – Time Domain Analysis

TDR – Time Domain Reflectometry

TDT – Time Domain Transmission

WC – Worst Case crosstalk configuration

Z – Impedance (expressed in ohms)